

DOOR 1 TENANT 1

DA-1DS

Single Tenant Entry Security

Entrance Station

DOOR 1



DA-1DS
Entrance Station
(Not sold separately)

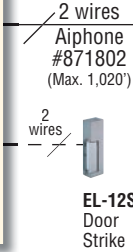

Tenant Station

TENANT 1



DA-1MD
Master Station

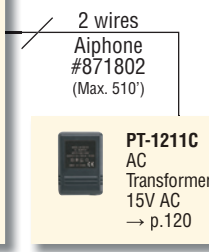

Options & Accessories



DAW-P
Mounting Plate for DA-1DS door stations → p.122



EL-12S
Electric Door Strike, 12V AC/DC, 200mA → p.112



DAR-1
Call Extension Sounder → p.111

Features (DA-1DS / DA-2DS / DA-4DS)

- Door release powered by door station without the need of an additional transformer or wiring
- Service button to control an external device
- Call tone volume control with mute indicator
- Optional call extension sounder
- Backlit directory

Unit Dimensions

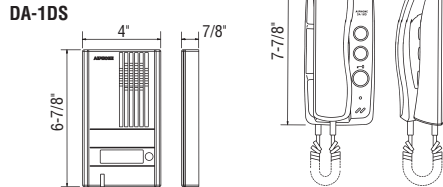

Wiring

NOTE: For door release use EL-12S or AC 9.5V ~ 20V, 70Ω

OTHER NOTES:

1. Place PT-1211C inside electrical enclosure and connect to breaker, less than 16V
2. Do not use PT-1211C for any other equipment
3. Terminals SW, SW: Dry-closure contact less than 18V AC, 40mA to connect user - optional function Gate, Light, Garage, Proximity Access Control, etc.

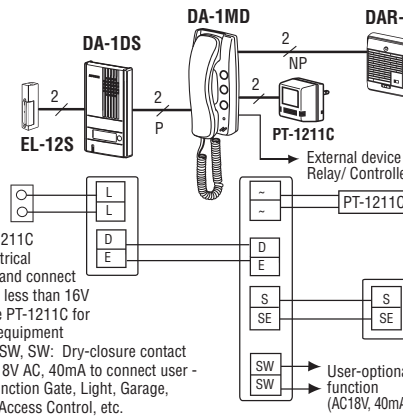

Boxed Set



DA-1AS:
DA-1MD, DA-1DS, and power supply

Specifications (see DA-2DS / DA-4DS specs below)

DOOR 1 TENANT 4

DA-4DS

Multi-Tenant Entry Security

Entrance Stations - Select 1 unit

DOOR 1



DA-2DS
2-Call Entrance Station



DA-4DS
4-Call Entrance Station

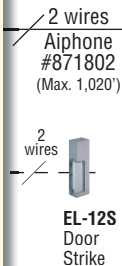

Tenant Station - Up to 4 tenants

TENANT 1 ~ 4



DA-1MD
Master Station

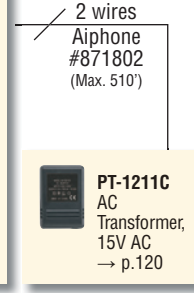

Options & Accessories



DAW-P
Mounting Plate for DA-2DS/4DS door stations → p.122



EL-12S
Electric Door Strike, 12V AC/DC, 200mA → p.112



DAR-1
Call Extension Sounder → p.111

Unit Dimensions

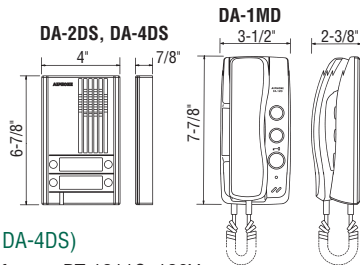

Wiring

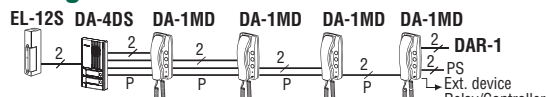

NOTE: For door release use EL-12S or AC 16V, 70Ω

When a single power supply is used:

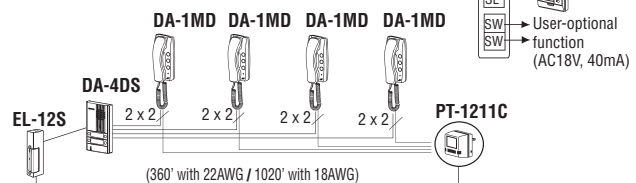

Features (see DA-1DS features above)

Specifications (DA-1DS / DA-2DS / DA-4DS)

- Power Source** 15V AC - Use AC transformer PT-1211C, 120V
- Communication** Push and hold down button to call
- Door Release** Contact rating: AC -9.5V~20V, 70Ω resistance, or use EL-12S
- Wiring** Door to master: 2-cond., overall shield
- Distance** Door to master: 360'(22AWG) 1020'(18AWG)
Door strike to power supply: 360'(22AWG) 1020'(18AWG)
- Wire Type** Aiphone #822202 or Aiphone #871802