

AIPHONE



GT SYSTEM

Video Multi-Tenant System

GT system is ideal for large scale residential Style mixed with IP technology. Enable



5,000

Aiphone's multi-tenant system can now serve up to 5,000 residences. ▶ P08

- Install one system for housing complexes with multiple buildings.
- Cover a building with more than 500 units with one system.

7-inch

Designed to be even easier to use. ▶ P05

- Tenant station features a clear 7-inch display.
- Compact and intuitive functional design.



IP and NFC technologies enable effective management. ▶ P09

- Building management from anywhere via IP network connection.
- Built-in NFC reader for easy programming and tenant management.

developments with multiple buildings.
creation of new solutions.



Multi building development



Large scale residential building



Gated community/
Villa

GT-1C7



Tenant Station

7-inch display (GT-1C7)



- High-resolution, 7-inch display makes visitors easy to recognize.
- Functional design, intuitive control: illuminated easy-to-see buttons for door release and communication during calls from entrances.

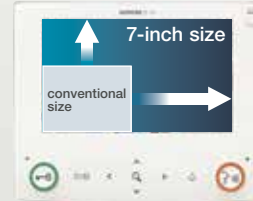

Wide / Zoom & PanTilt



- Panoramic Wide Angle View
To provide effective security, GT System features a wide angle camera that enables you to see a clear panoramic view. Easily see and identify visitors standing on the sides and people of all heights.



Wide Image



Zoom Image



PanTilt Image (GT-1C7, GT-2C only)

Door release

- Confirm the visitor and surroundings then open the entrance from inside.



Selection of tenant stations for all needs



- GT-1C7**
Color display tenant station
- 7-inch display
 - Hands-free



- GT-1M3**
Color display tenant station
- 3.5-inch display
 - Hands-free



- GT-2C**
Color display tenant station
- 3.5-inch display
 - Picture memory
 - Optional individual door station
 - Optional handset (GT-HS)



- GT-1A**
Audio tenant station
- Hands-free



- GT-1D**
Audio tenant station
- Handset

Entrance Station

All-in-one type / Module type



Panoramic view angle & clear color image



- 170° angle wide view camera.
- White light LED illuminates automatically in low-light conditions.

Optional security camera for more security

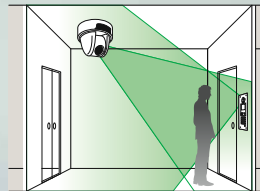

- Connect an additional CCTV camera. You can select one of the cameras placed at the entrance for monitoring. This allows you to confirm visitors from various angles, thus enabling the prevention of intrusion by suspicious individuals.

NFC Reader

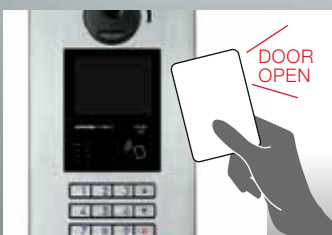

- Use the NFC reader or access codes for lock control.
- The NFC reader can also be used for programming the system. (→P.09)

2 panel styles

- 2 styles to choose from: All-in-one type or Module type.
- Module type allows audio only and other configurations.



All-in-one type

Module type

Concierge Station



3.5-inch display

- Easy operation for all concierge functions.
- Video monitoring of entrance stations.

Wide / Zoom & PanTilt

- See the 170° wide view video from the entrance stations.
- Use zoom and pantilt functions for a detailed view.

Reception mode function

- Using this function, all entrance station calls are automatically transferred to the concierge station, giving the concierge the ability to screen visitors.

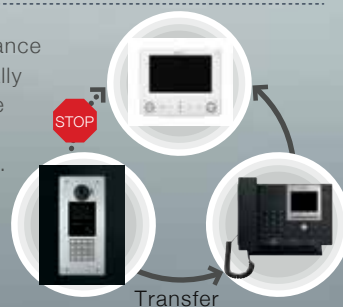

Can connect an individual video door station (JO-DV)

- Automatic LED illuminator for low light conditions.



JO-DV

System Variation

Single building system

- Ideal for small- and medium-size residential buildings.
- Audio only configuration also possible.

Maximum Capacity

	Tenant building / section	
	Standard system	Expanded system
Entrance station	5	16
Concierge station	2	4
Tenant station	48*1	500

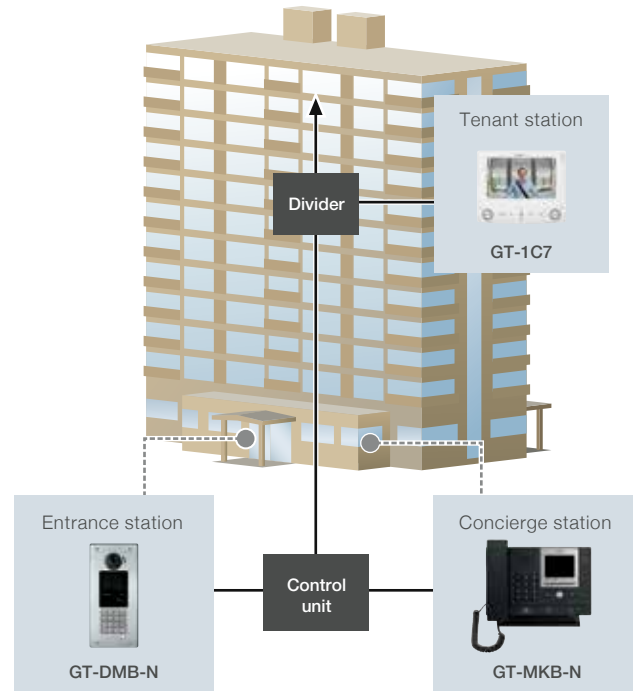

*1: Up to 100 GT-1D audio tenant stations can be connected when configuring a standard audio only system.

5,000

Multi building system

- Install one system for housing complexes with multiple buildings.
- Cover a building with more than 500 units with one system.
- Building management from anywhere via IP network connection.
- Audio only configuration for tenant buildings also possible.

Maximum Capacity (Number of stations are per building / section)

	Tenant building / section		Common building / section	
	Standard system	Expanded system	Standard system	Expanded system
Entrance station	4	15	4	15
Concierge station	1	3	1	3
Tenant station	48	500	—	—

Total maximum capacity

(Total for tenant building / section and common building / section)

Entrance station	480
Concierge station	96
Tenant station	5,000

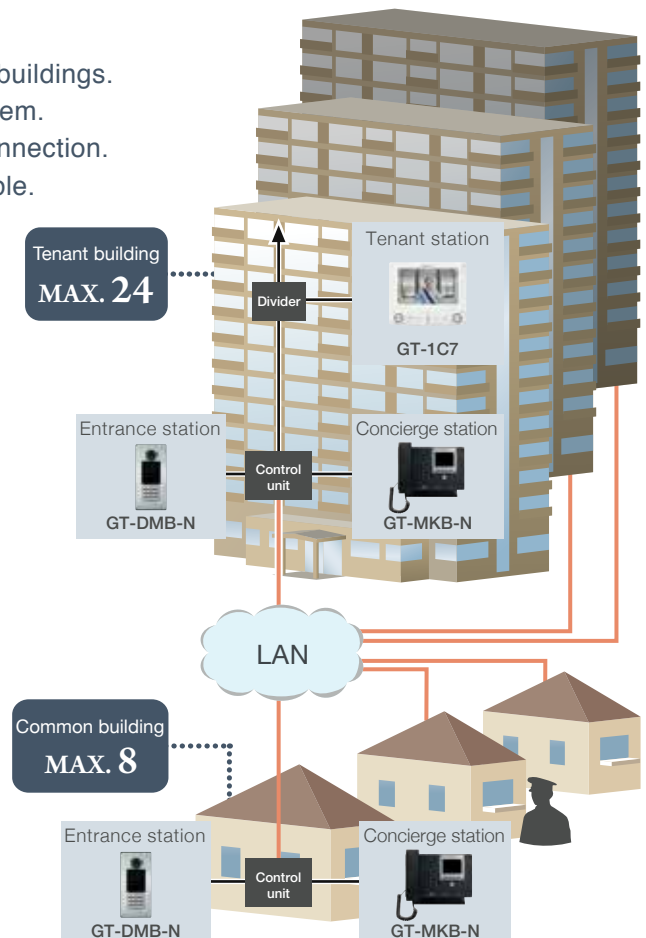



IP technology

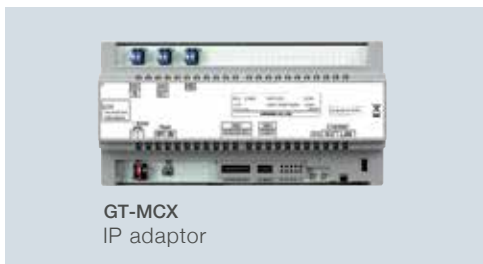

- Multiple tenant buildings and main buildings can be connected via an IP network to create a multi building system for centralized management.
- A maximum of 24 tenant buildings and 8 main buildings can be connected.
- Multiple tenant buildings can be combined to accommodate large-scale residential buildings with more than 500 units.
- Connects buildings together and enables communication.

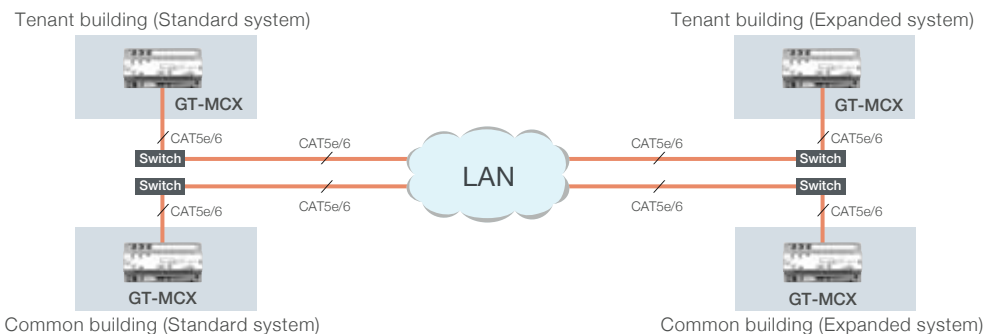

System programming and NFC technology

Easy system setting on a PC or Android mobile device

- Settings can be made from a PC or Android mobile device by using GT Setup Tool.
- Supported OS: Windows 7, 8.1, 10.*1
- Supported Android OS version: Android 5.0 and greater.

*1: For operating systems not listed, please contact your Aiphone dealer.



GT Setup Tool for Windows



GT Setup Tool for Android

Uploading the setting data

Uploading using an Android mobile device for GT-DMB-N, GT-DB-VN, GT-MKB-N, GT-BCXB-N (W/NFC reader)

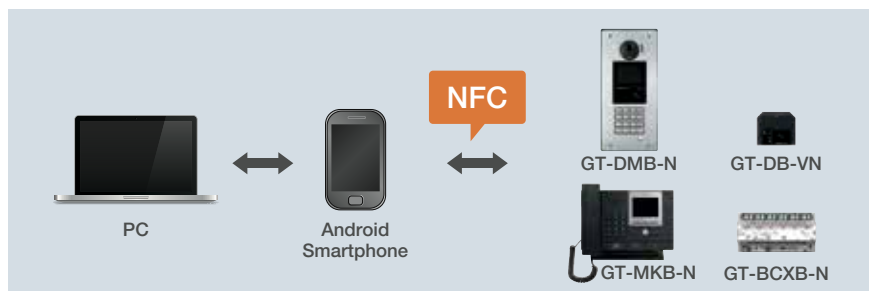

Connecting a unit to a PC via USB

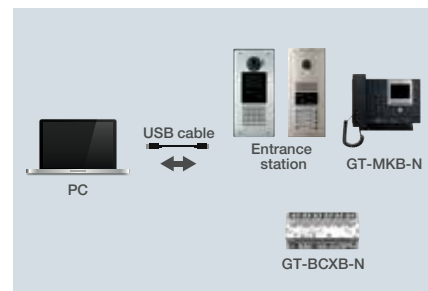

Uploading using a network connection

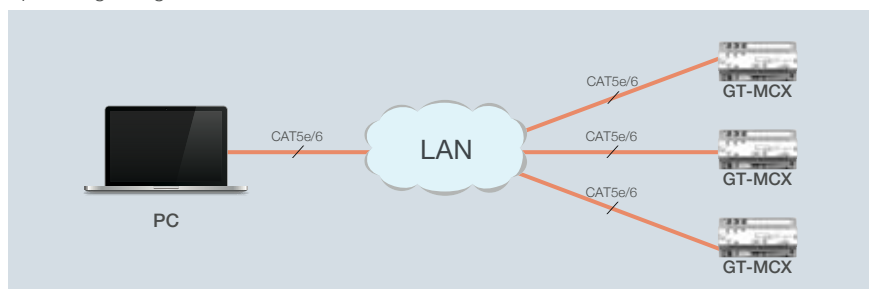

Multi Building Development

Installation example

e.g. 4 Tenant buildings (4 Entrance stations, 4 Concierge stations, 1,060 Tenant stations)
2 Common buildings (2 Entrance stations, 6 Concierge stations)

- Can be configured as a single system without creating separate systems for each building.
- Connect buildings through an IP network. Ideal for large sites with long distances between buildings.
- The common building can communicate with all tenant buildings.

Proposed system:

- 1 Standard system, 3 Expanded systems in tenant buildings.
- 2 Expanded systems in common buildings. (Maximum capacity → P.08)

*Possible to mix video and audio only systems.

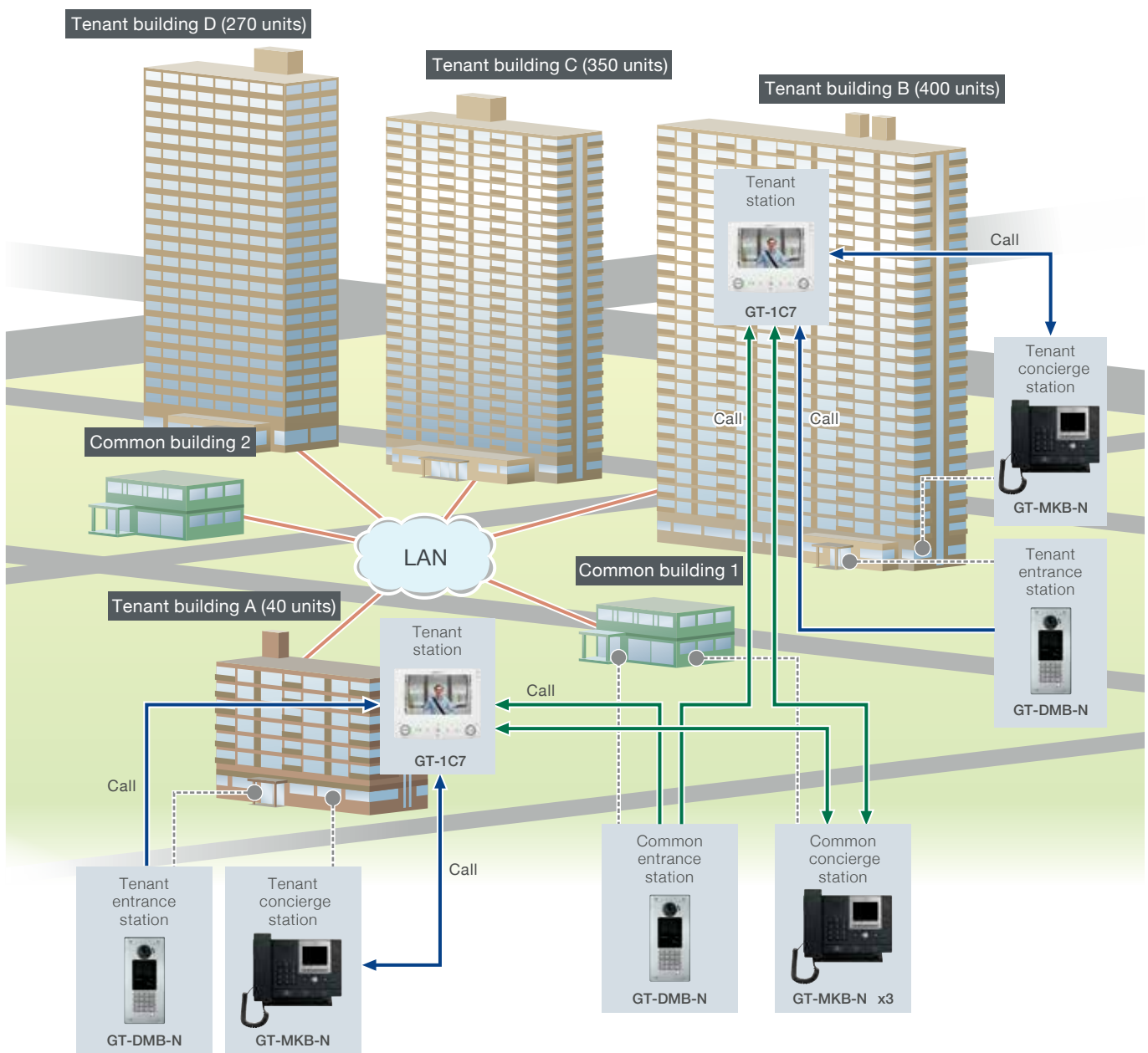

Tenant building A, B, C, D: In the above example, tenant buildings mean residential buildings and towers.

Common building 1 & 2: In the above example, common buildings mean buildings such as security centers and administrative offices.

System configuration example

Tenant building A: 40 units (Standard system)

Total max. wiring distance is 2,500m.
Do not mix wiring methods within individual trunk lines.

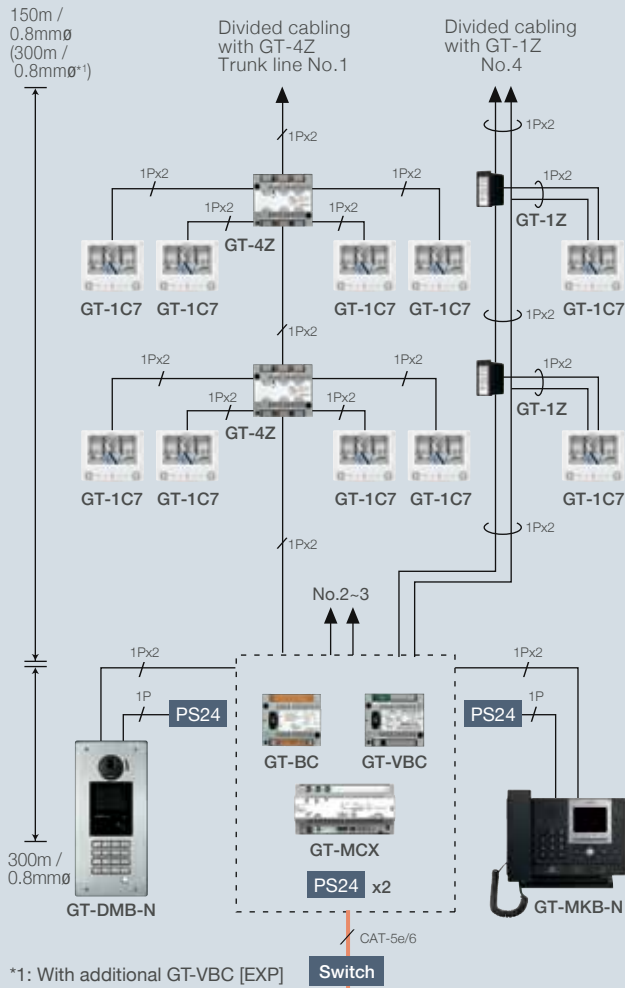

Tenant building B: 400 units (Expanded system)

4 sub trunk lines (SUB1A, 1B, 2A, 2B)
Max. 125 Tenant stations and max. 2,500m wiring distance for each sub trunk line. Total max. wiring distance is 10,000m.
Do not mix wiring methods within individual trunk lines.

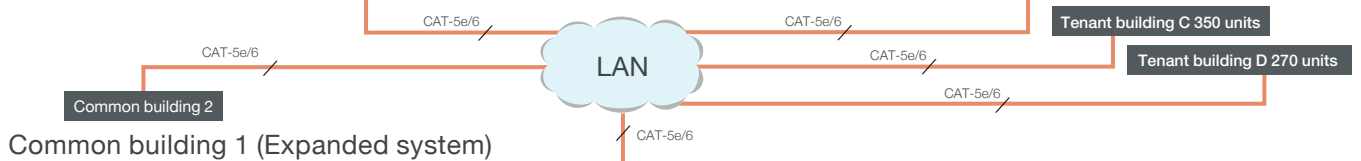
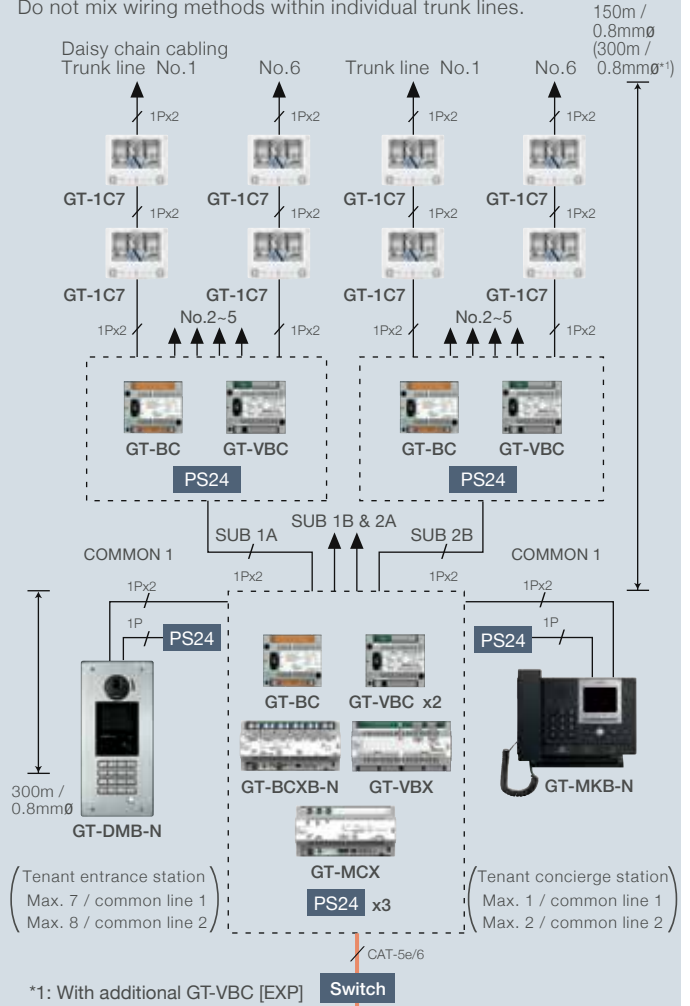

Common building 1 (Expanded system)

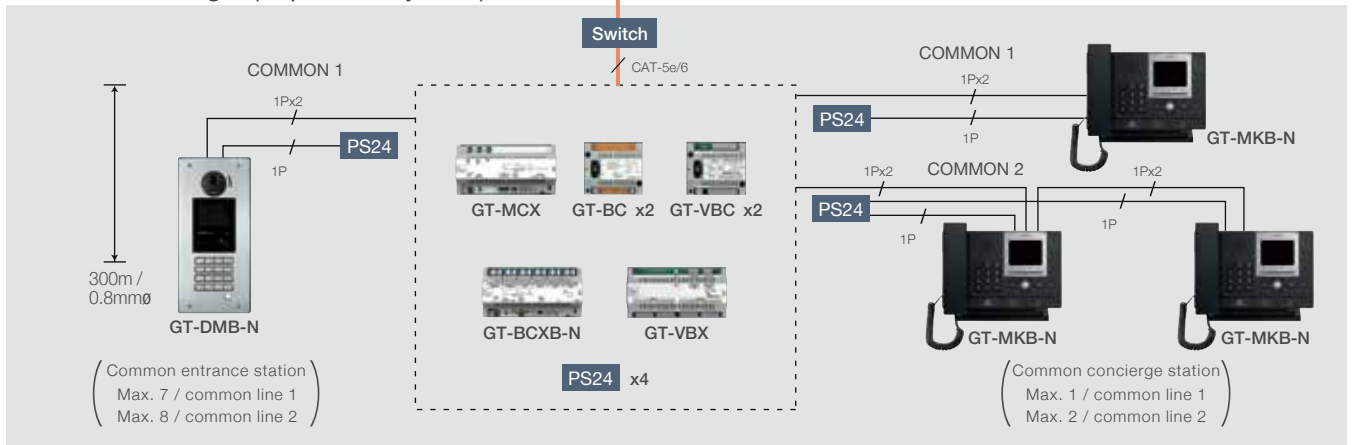

*Cable: 1Px2, 2-conductor cable solid copper & non-braided, polyethylene insulation.

Large Scale Residential Building (more than 500 units)

Installation example

e.g. 3 Tenant sections (1,100 Tenant stations)

1 Common section (3 Entrance stations, 3 Concierge stations)

- Multi-building control units allow systems to be configured without having to use separate systems for each section.
- All tenant stations can be called from any entrance station or concierge station.

Proposed system:

3 Expanded systems in tenant sections

1 Expanded system in common section

(Maximum capacity → P.08)

*Possible to mix video and audio only systems.

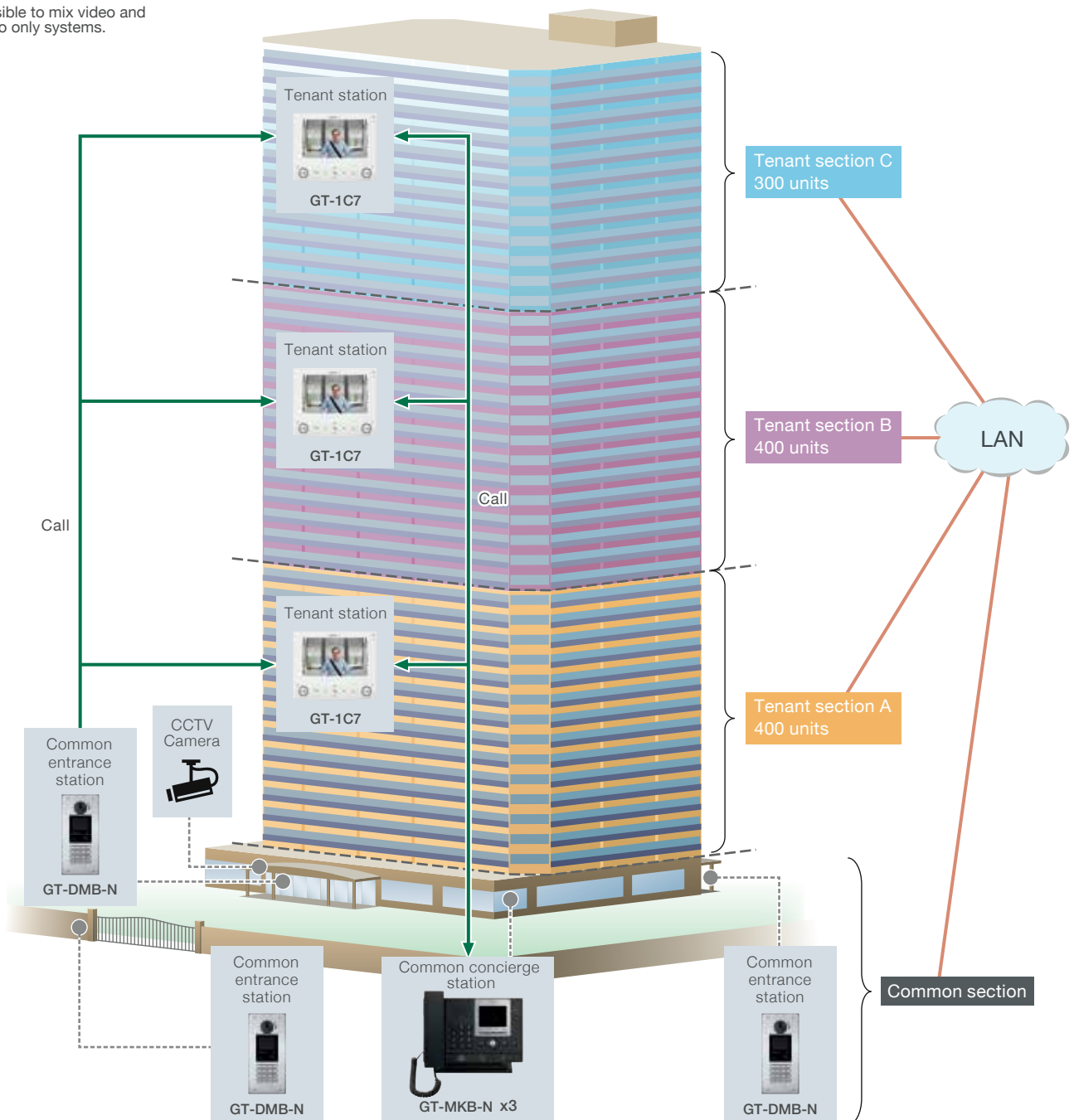

Common section: In the above example, common section means lobby and common entrance.

System configuration example

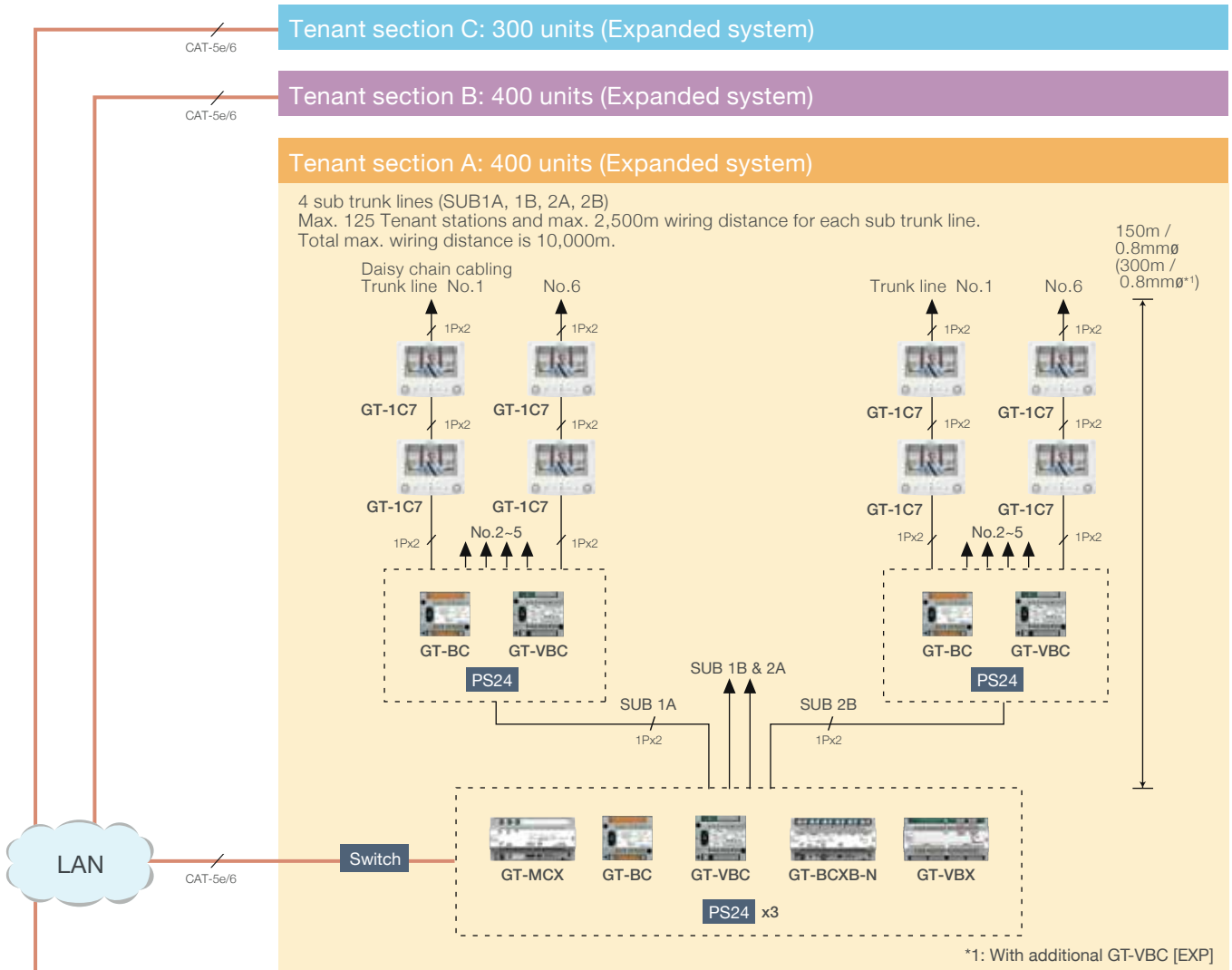

Common section (Expanded system)

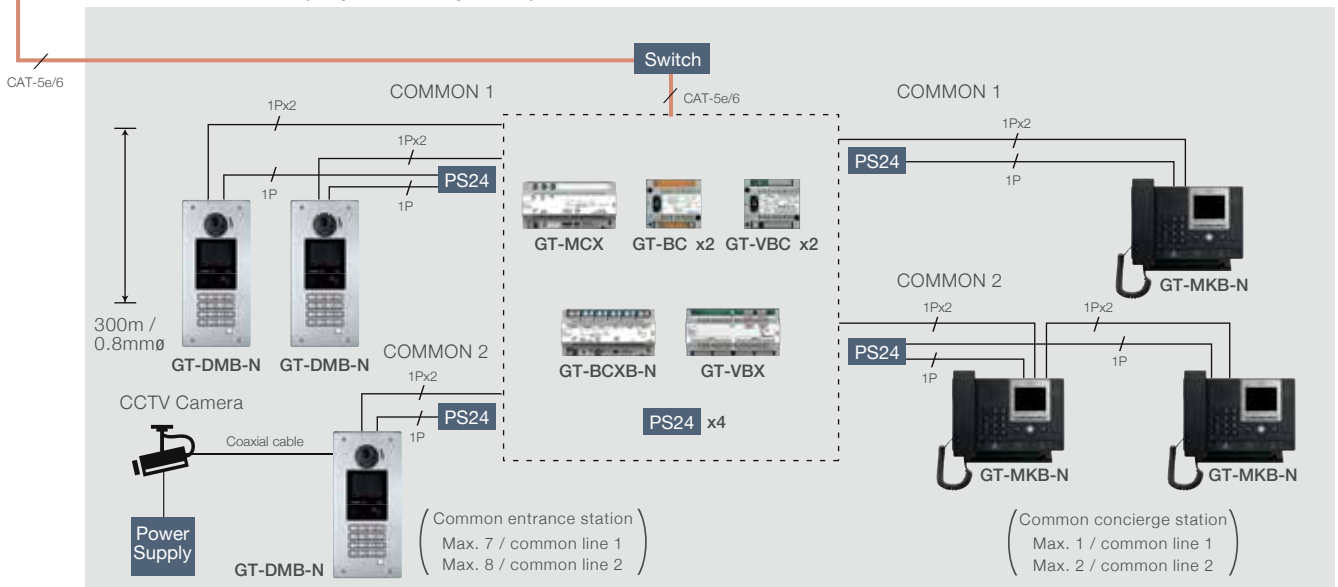

*Cable: 1Px2, 2-conductor cable solid copper & non-braided, polyethylene insulation.

Installation example

e.g. 2 Tenant sections (60 Tenant stations)

1 Tenant building (1 Entrance station, 1 Concierge station, 400 Tenant stations)

1 Common section (1 Concierge station)

- All sections (buildings) can be configured in a single system without creating separate systems for different types of buildings.
- Connect sections through an IP network. Ideal for large sites with long distances between sections.
- The common section can communicate with all tenant sections.

Proposed system:

2 Standard systems in tenant sections.

1 Expanded system in tenant building.

1 Standard system in common section. (Maximum capacity → P.08)

*Possible to mix video and audio only systems.

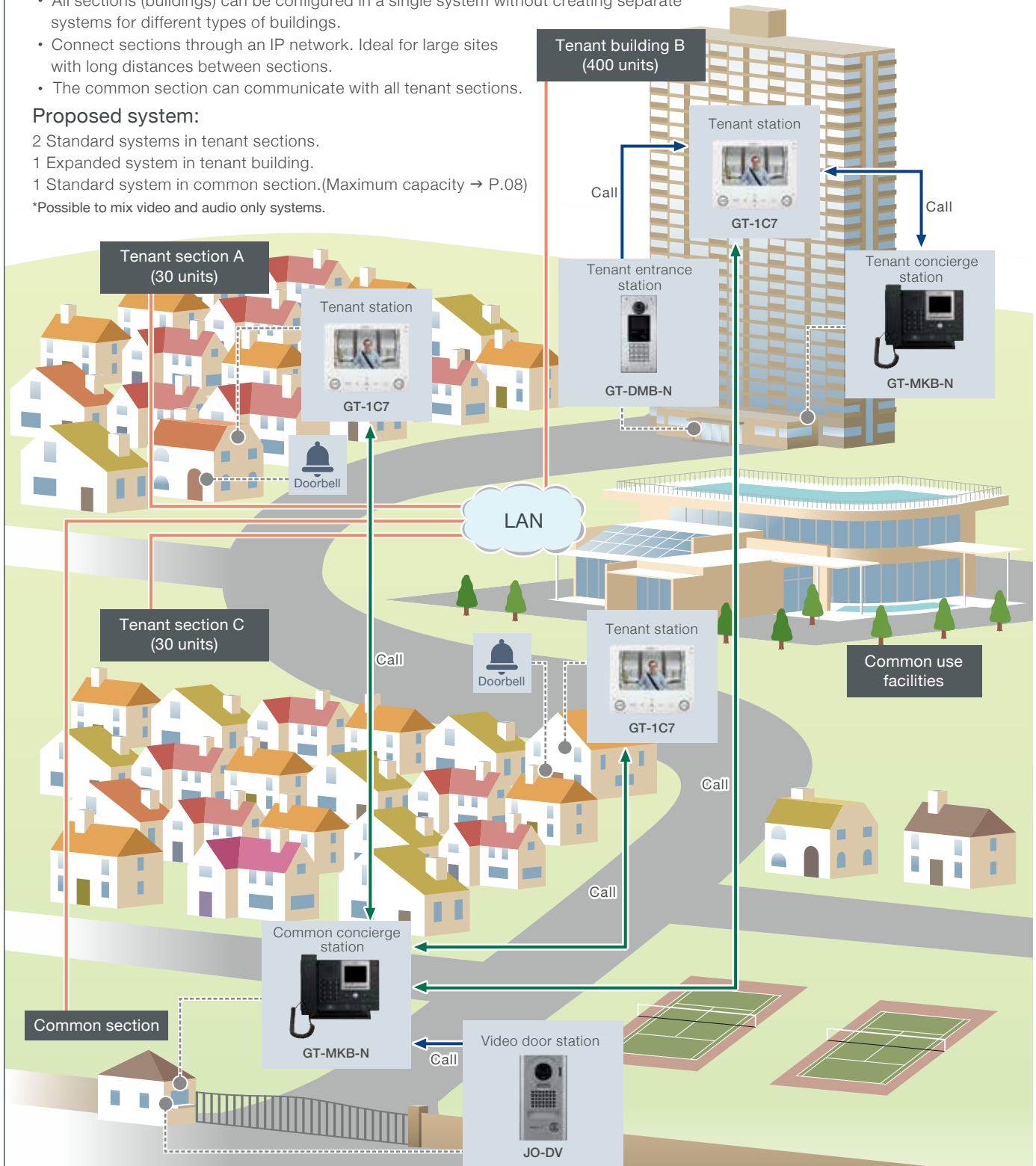

Tenant section A, C: In the above example, tenant sections mean individual housing sections.

Tenant building B: In the above example, tenant building means residential tower.

Common section 1: In the above example, common section means buildings such as security centers and administrative offices.

System configuration example

Tenant section A & C: 30 units (Standard system)

Total max. wiring distance is 2,500m.
Do not mix wiring methods within individual trunk lines.

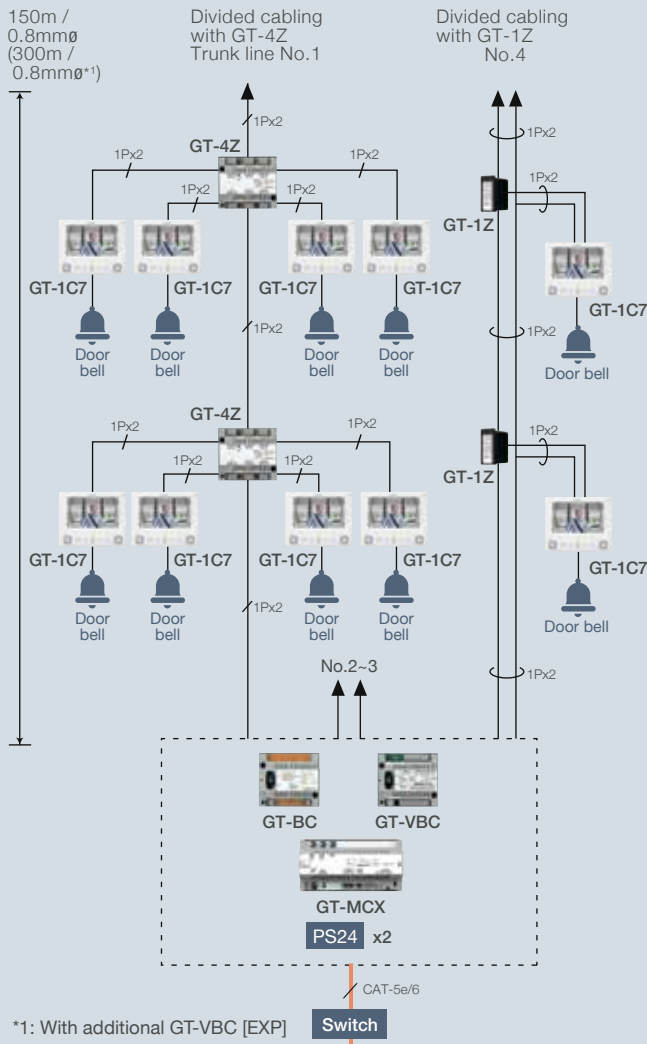

Tenant building B: 400 units (Expanded system)

4 sub trunk lines (SUB1A, 1B, 2A, 2B)
Max. 125 Tenant stations and max. 2,500m wiring distance for each sub trunk line. Total max. wiring distance is 10,000m.
Do not mix wiring methods within individual trunk lines.

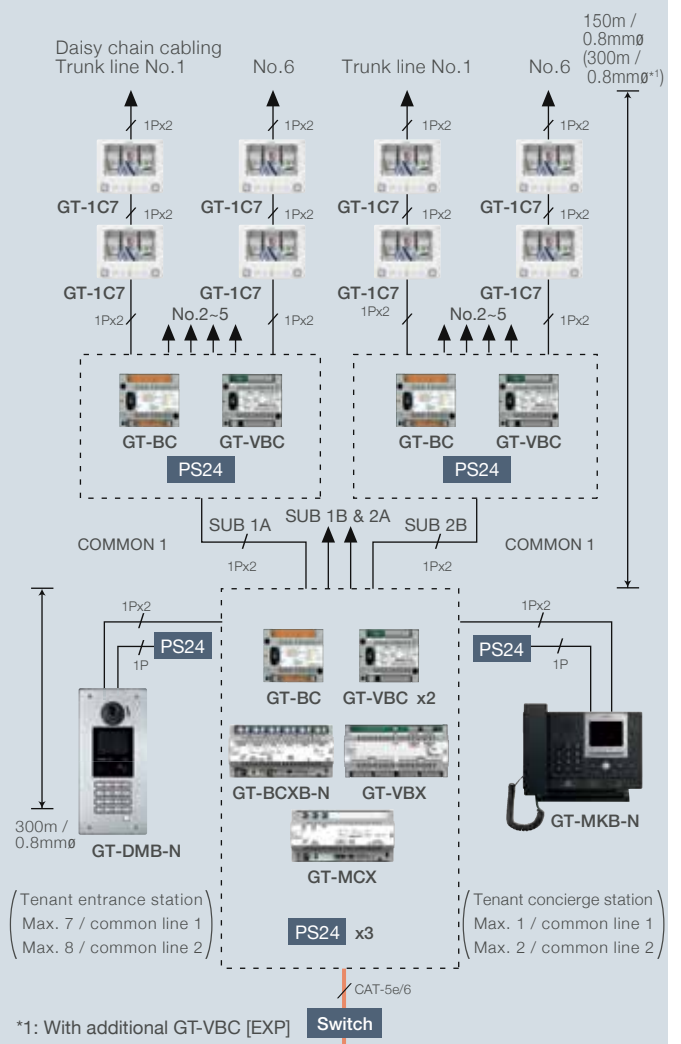

Common section (Standard system)

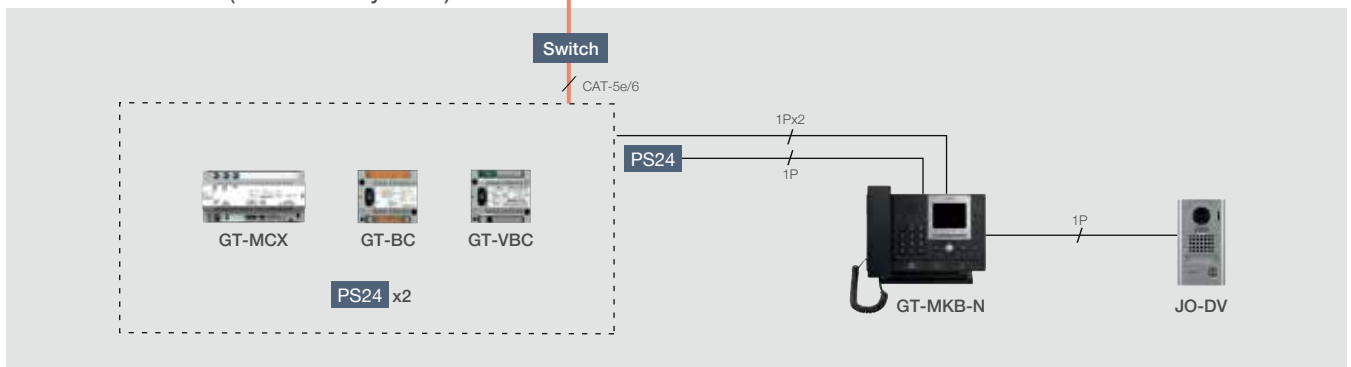

*Cable: 1Px2, 2-conductor cable solid copper & non-braided, polyethylene insulation.

Small Residential Building (e.g. 20 units)

Installation example

e.g. 1 Tenant building (1 Entrance station, 1 Concierge station, 20 Tenant stations)

Proposed system:

1 Standard system in tenant building.

(Maximum capacity → P.08)

*Possible to mix video and audio only tenant stations.

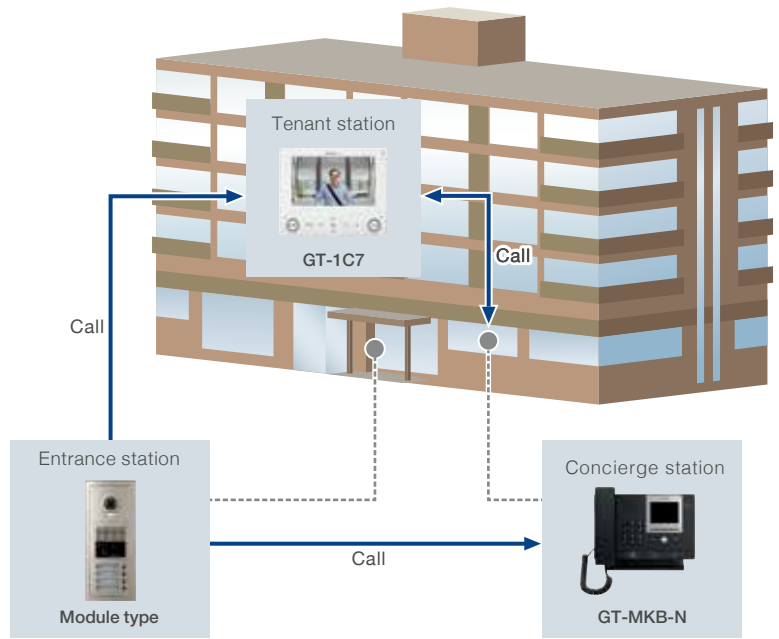

System configuration example

Total max. wiring distance is 2,500m.

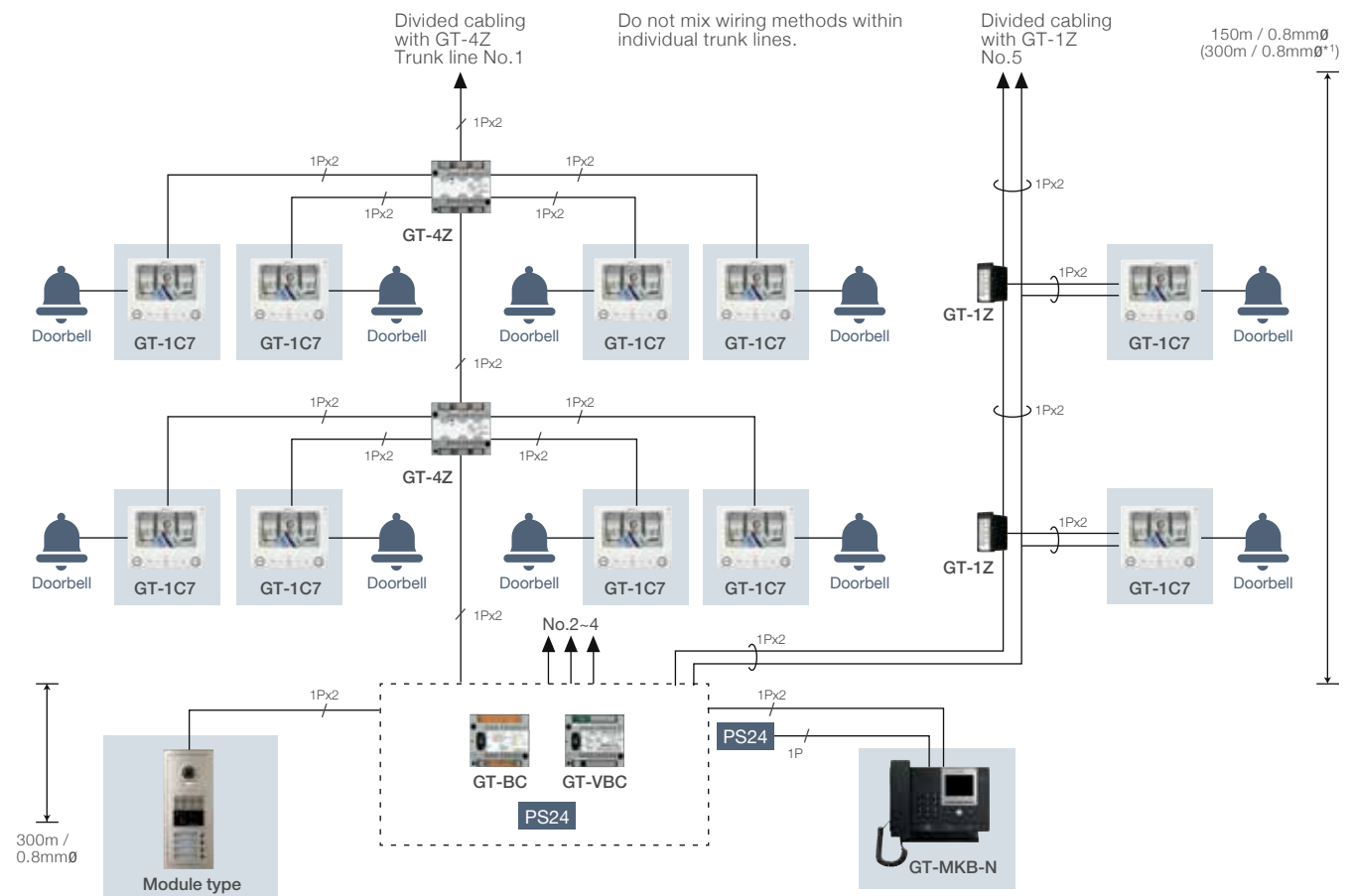

*Cable: 1Px2, 2-conductor cable solid copper & non-braided, polyethylene insulation.

*1: With additional GT-VBC [EXP]

Medium-Size Residential Building (e.g. 150 units)

Installation example

e.g. 1 Tenant building (2 Entrance stations, 2 Concierge stations, 150 Tenant stations)

Proposed system:

1 Expanded system in tenant building.
(Maximum capacity → P.08)

*Possible to mix video and audio only tenant stations.

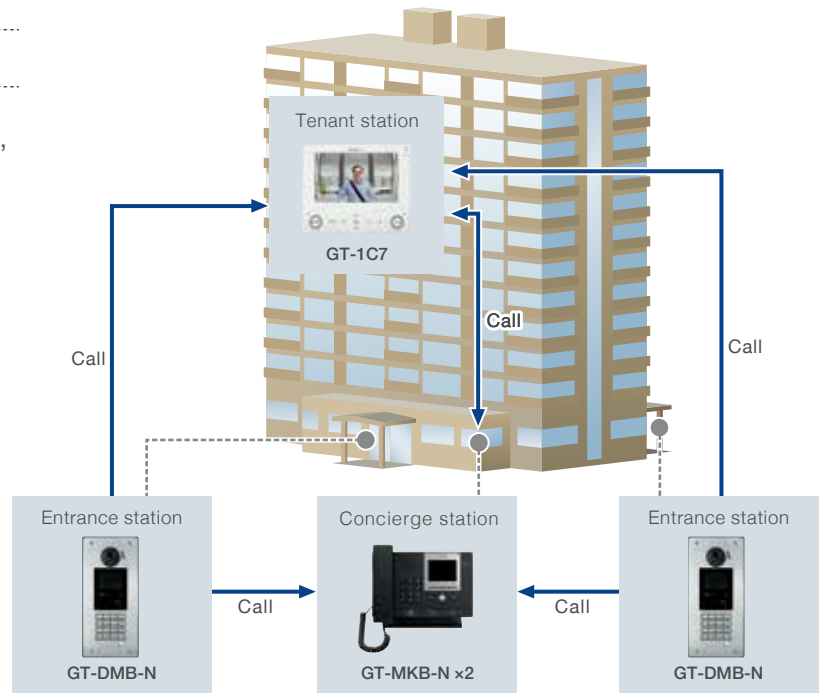

System configuration example

4 sub trunk lines (SUB1A, 1B, 2A, 2B)
Max. 125 tenant stations and max. 2,500m wiring distance for each sub trunk line.
Total max. wiring distance is 10,000m.

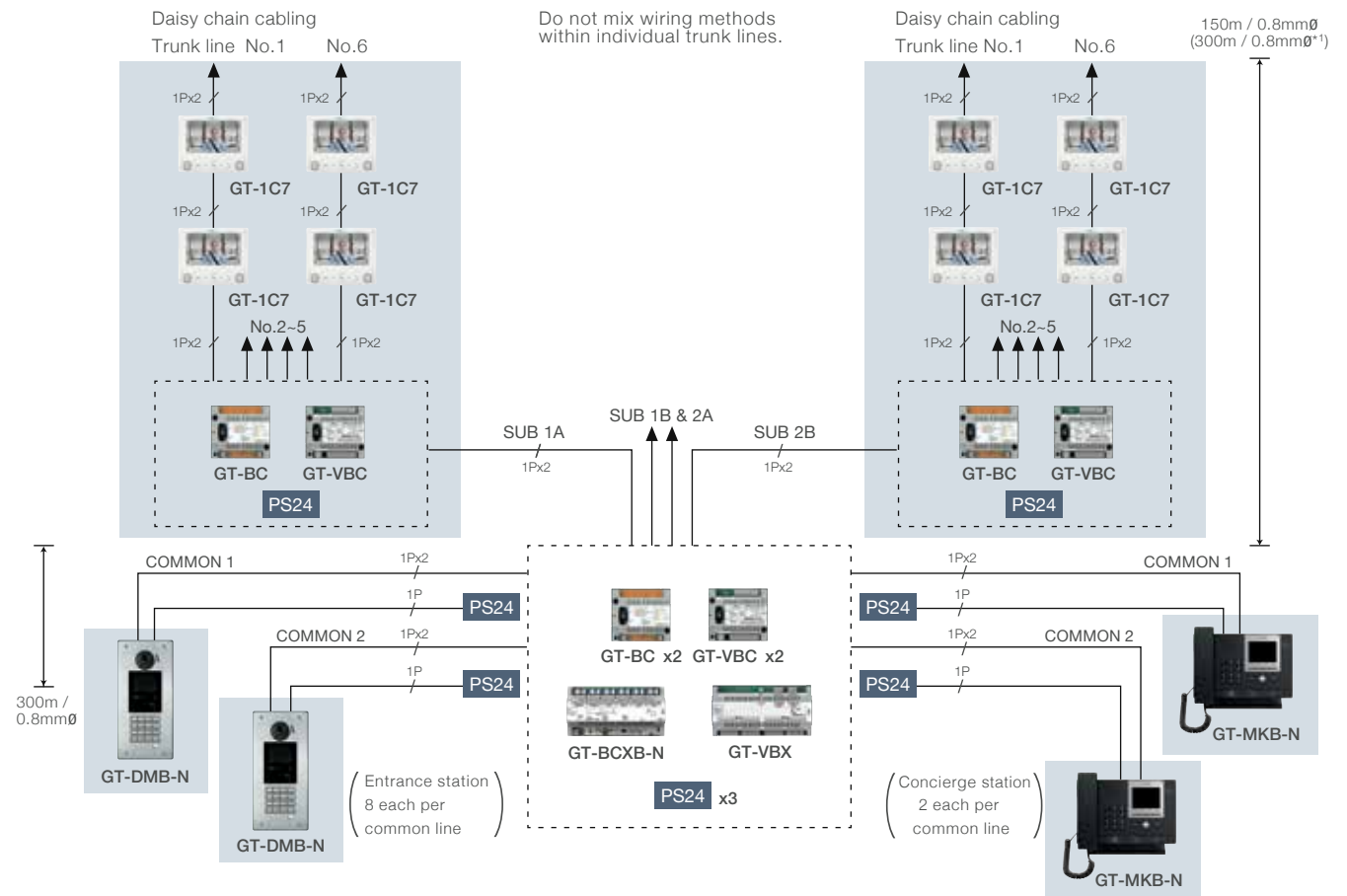

*Cable: 1Px2, 2-conductor cable solid copper & non-braided, polyethylene insulation.

*1: With additional GT-VBC [EXP]

System Components

Entrance station

All-in-one type



GT-DMB-N
Entrance station
W/NFC reader
(Back box not included.)
Use GF-3B.

- 170° angle wide view camera.
- Audio & visual guidance to provide visitors status and operation assistance.
- Search names and numbers using the keypad.
- Custom programmable welcome messages can be displayed.
- 9 languages (English, French, German, Spanish, Dutch, Italian, Norwegian, Turkish and Finnish) are available for messages on Guidance display.
- 6 languages (English, French, German, Spanish, Dutch and Norwegian) are available for audio guidance.
- White light LED illuminates automatically in low-light conditions.

Module type



Camera Module



GT-VP Camera panel
GT-VB Camera module for GT-DB(-VN)

Call switch Module



GF-1P 1-call panel
GF-2P 2-call panel
GF-3P 3-call panel
GF-4P 4-call panel
GT-SW Call switch module

Audio Module



GT-DBP Audio panel for GT-DB(-VN)
GT-DB*1 Audio module W/O NFC reader
GT-DB-VN*1 Audio module W/NFC reader

Digital name scrolling module



GT-NSP-L Display module panel
GT-NSB Digital name scroll display module for GT-DB(-VN)

Front frame & back box



GF-10KP 10-key module panel
GT-10K 10-key module



GT-4F 4-module front frame



GT-4B 4-module back box

GF-3F 3-module front frame

GF-3B 3-module back box

GF-2F 2-module front frame

GF-2B 2-module back box

Access control keypad module



GT-AC Access control keypad module
GT-HID Card reader panel

Option



GF-AP Address module panel
GT-AD Address module
GF-BP Blank panel



GT-nH Rain hood



GT-nHB Hooded surface-mount box

*1: GT-DB and GT-DB-VN cannot be used in the main buildings of a multi building systems.

Concierge station



GT-MKB-N
Guard station

Power supply



PS-2420

Door station

Video door station for GT-2C



JK-DA
Wide / Zoom & PanTilt
video door station,
surface mount



JK-DV
Wide / Zoom & PanTilt
Vandal resistant video
door station, surface mount



JK-DVF
Wide / Zoom & PanTilt
Vandal resistant video
door station, flush mount

Door station for GT-2C



GT-D
Audio only door
station, surface mount

Video door station for GT-MKB-N



JO-DV
Vandal resistant
video door station,
surface mount



Option



GT-RY
External signaling
relay for entrance light,
external buzzer



W-DIN11
DIN mounting rail
for GT-BC, GT-VBC, GT-4Z



AC-10S
Access control
keypad,
surface mount



AC-10F
Access control
keypad,
flush mount

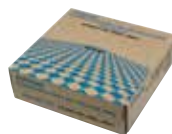

**AE7090220B AE7090220G
AE7090210B AE7090210G**
AIPHONE approved product wire

Tenant station



GT-1C7
Color display tenant station



GT-1M3
Color display tenant station



GT-2C
Color display tenant station



GT-2H
Color display sub tenant station



GT-HS
Handset
for GT-2C, GT-2H



GT-1A
Audio tenant station



GT-1D
Audio tenant station

Control units

Control units



GT-BC
Bus control unit



GT-VBC
Video bus control unit,
expander video control



GT-4Z
4-way video
junction unit



GT-1Z
Video 1-zone
divider

Expanded control units



GT-BCXB-N
Expanded bus control unit



GT-VBX
Expanded video bus control unit

IP adaptor



GT-MCX
IP adaptor

Lift control adaptor



GTW-LC
Lift control adaptor

Unit Dimensions (mm)

Entrance station

GT-DMB-N (with GF-3B)

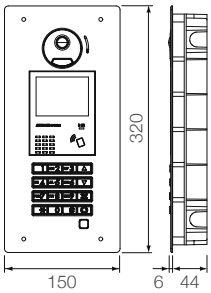

Audio / Video + Name scroll (with GT-4B)

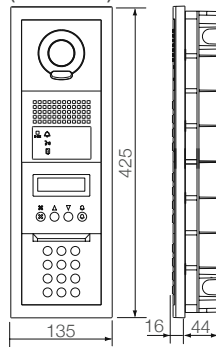

4-call (with GF-3B)

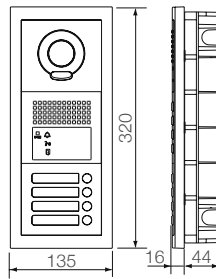

Audio / Video + Name scroll (with GF-2Bx2)

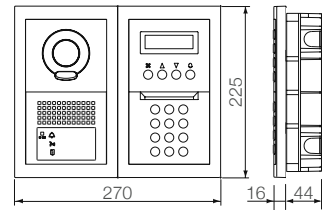

GT-VP

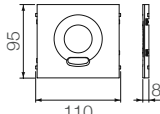

GT-VB

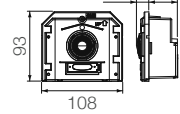

GF-4P

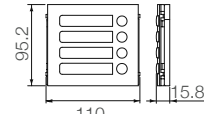

GT-SW

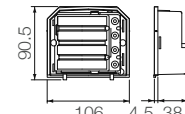

GT-NSP-L

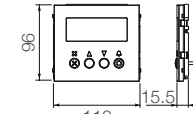

GT-NSB

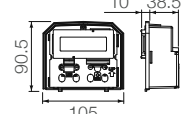

GT-DBP

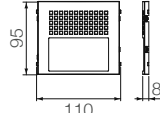

GT-DB / GT-DB-VN

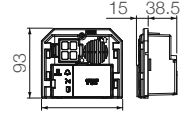

GF-10KP

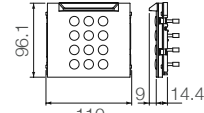

GT-10K

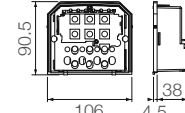

GT-AC

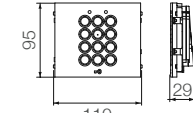

GT-4F

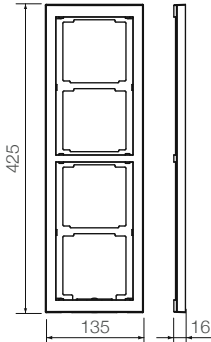

GT-4B

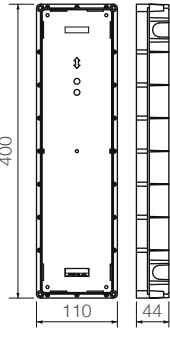

GT-104H

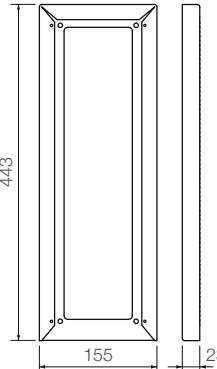

GT-104HB

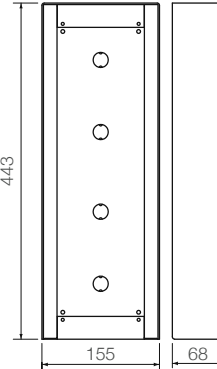
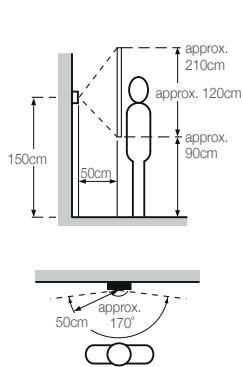
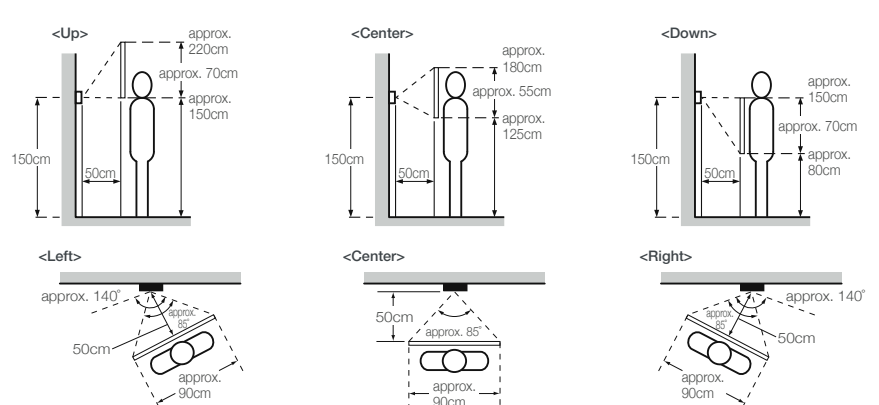

Image view area

WIDE



ZOOM & PanTilt



Concierge station

GT-MKB-N

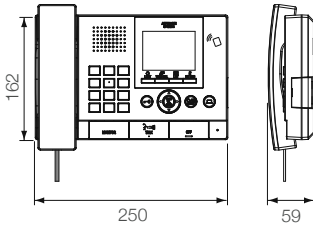

Power supply

PS-2420

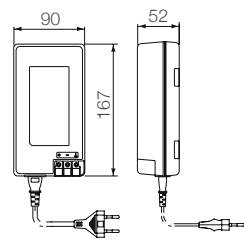

Door station

JK-DA

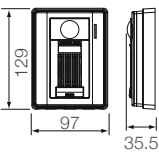

JK-DV

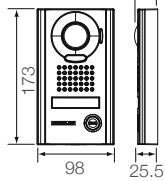

JK-DVF

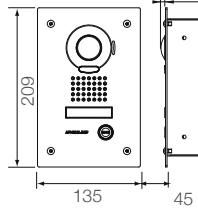

GT-D

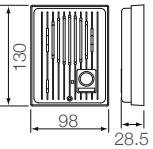

JO-DV

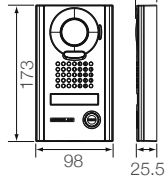

Lift control adaptor GTW-LC

Installing a lift control adaptor gives the option to control lifts from the tenant station.

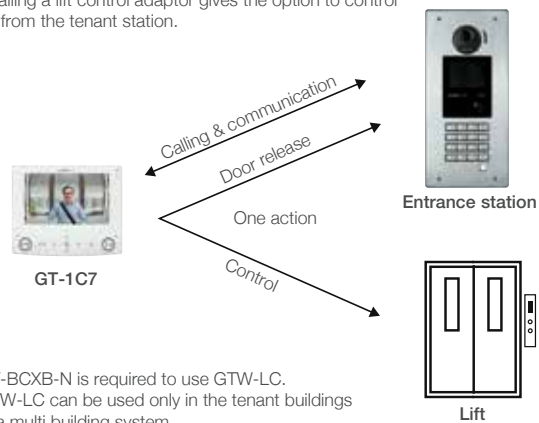

*GT-BCXB-N is required to use GTW-LC.
*GTW-LC can be used only in the tenant buildings of a multi building system.

Tenant station

GT-1C7

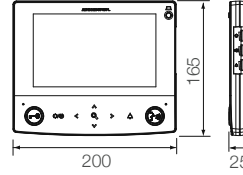

GT-1M3

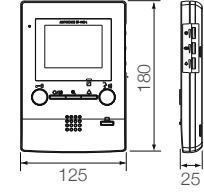

GT-2C, GT-2H

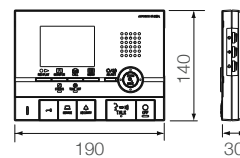

GT-HS

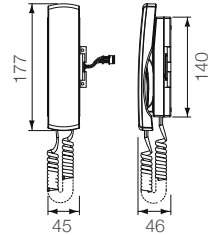

GT-1A

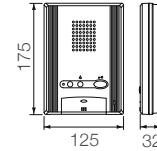

GT-1D

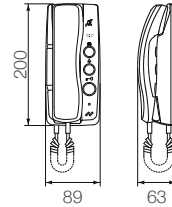

Control units

GT-BC, GT-VBC, GT-4Z

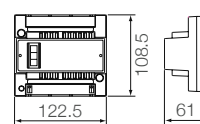

GT-1Z

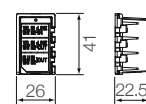

GT-BCXB-N



GT-VBX

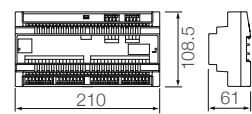

GT-MCX

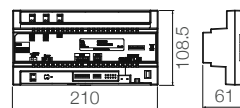

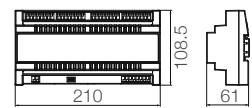

GTW-LC



Hands-Free Color Video Multi-Tenant Building System with Zoom & PanTilt

Number of system components according to system type







Number of necessary control units at maximum tenant station and common equipment capacity.

	Building / Section type	System type	VIDEO / AUDIO	Max. Tenant station	Max. Entrance stations		Max. Concierge station
					 GT-DMB-N	 Module type	 GT-MKB-N
Single building system (Max. 500 units)	Tenant building	Standard	VIDEO	48 *1	5		2
			AUDIO	100 *2	5		2
		Expanded	VIDEO	500 *1	16		4
			AUDIO	500	16		4
Multi building system (Max. 5,000 units)	Tenant building (Max. 24 buildings)	Standard	VIDEO	48 *1	4		1
			AUDIO	100	4		1
		Expanded	VIDEO	500*1	15		3
			AUDIO	500	15		3
	Common building (Max. 8 buildings)	Standard	VIDEO	×	4	×	1
			AUDIO	×	4	×	1
		Expanded	VIDEO	×	15	×	3
			AUDIO	×	15	×	3

*Number of stations, units and power supply are per building.

Examples of multi-building system configurations

	Building / Section type	System type	VIDEO / AUDIO	Tenant station*1	Entrance stations		Concierge station
					GT-DMB-N	Module type	GT-MKB-N
Multi building development (P10)	4 Tenant buildings	A:Standard	VIDEO	40	1	—	1
		B:Expanded	VIDEO	400	1	—	1
		C:Expanded	VIDEO	350	1	—	1
		D:Expanded	VIDEO	270	1	—	1
	2 Common buildings	1:Expanded	VIDEO	—	1	—	3
		2:Expanded	VIDEO	—	1	—	3
Total				1060	6	0	10
Large scale residential building (P12)	3 Tenant sections	A:Expanded	VIDEO	400	—	—	—
		B:Expanded	VIDEO	400	—	—	—
		C:Expanded	VIDEO	300	—	—	—
	1 Common sections	Expanded	VIDEO	—	3	—	3
Total				1100	3	0	3
Gated community / Villa (P14)	3 Tenant buildings / sections	A:Standard	VIDEO	30	—	—	—
		B:Expanded	VIDEO	400	1	—	1
		C:Standard	VIDEO	30	—	—	—
	1 Common sections	Standard	VIDEO	—	—	—	1
Total				460	1	0	2

Bus control units		Expanded bus control units		IP adaptor	Power supply	Lift control adaptor
						
GT-BC	GT-VBC	GT-BCXB-N	GT-VBX	GT-MCX	PS-2420	GTW-LC
1	1 *3	—	—	—	8	×
1	—	—	—	—	8	×
6	6 *3	1	1	—	27	○
6	—	1	—	—	27	○
1	1	—	—	1	7	×
1	—	—	—	1	7	×
6	6	1	1	1	26	○
6	—	1	—	1	26	○
1	1	—	—	1	7	×
1	—	—	—	1	7	×
2	2	1	1	1	22	×
2	—	1	—	1	22	×

*1: Please use a necessary number of GT-4Z / GT-1Z according to system design needs.

*2: Up to 100 GT-1D audio tenant stations can be connected when configuring a standard audio only system.

*3: The number of necessary units varies according to system size.

*Please follow installation manual when designing your system.

Bus control units		Expanded bus control units		IP adaptor	Power supply
GT-BC	GT-VBC	GT-BCXB-N	GT-VBX	GT-MCX	PS-2420
1	1	0	0	1	4
5	6	1	1	1	9
5	6	1	1	1	9
4	5	1	1	1	8
2	2	1	1	1	7
2	2	1	1	1	7
19	22	5	5	6	44
5	5	1	1	1	7
5	5	1	1	1	7
4	4	1	1	1	6
2	2	1	1	1	8
16	16	4	4	4	28
1	1	0	0	1	2
5	6	1	1	1	9
1	1	0	0	1	2
1	1	0	0	1	3
8	9	1	1	4	16

*1: Please use a necessary number of GT-4Z / GT-1Z according to system design needs.

*Please follow installation manual when designing your system.

Distributed by :

 **AIPHONE**®
Providing Peace of Mind

AIPHONE PTY LTD
Unit 11A, 2 Eden Park Drive
Macquarie Park, NSW 2113
Australia
Tel.: +61 2-8036-4507
URL: iphone.com.au



JQA-0291
Corresponding product:
Standard product
Order product



JQA-EM0453
HEADQUARTERS
TOYOTA FACTORY
TAIHOH SITE
DEVELOPMENT CENTER

GT(E)1701A

Printed in Australia
QB59022AWZ