

# Selector<sup>®</sup> 3700 Series Mortise Locks



We take the worry out of  
protecting what's valuable to you.  
Lockwood: *no worries*<sup>®</sup>

**LOCKWOOD**

**ASSA ABLOY**

**25YEAR**

**MECHANICAL  
WARRANTY**

[www.lockweb.com.au](http://www.lockweb.com.au)



# Contents



## **Selector® 3770 MKII Series**

Standard Backset

page 5



## **Selector® 3770 MKII**

Mortice Nightlatches

page 9



## **Selector® 3772 MKII**

Escape Locks

page 12



## **Selector® 3774 MKII**

Passage Latch

page 18



## **Selector® 3774 MKII**

Combination Locks

page 21



## **Selector® 3777 MKII**

Dual Entry Locks

page 26



## **Selector® Privacy MKII**

Privacy Locks

page 29



## **Selector® 3772 MKII DX Digital**

DX Digital Mortice Locks

page 33



## **Selector® 3772 MKII DX Digital**

Key Override DX Digital Mortice Locks

page 36



## **Selector® 3770 Series Accessories**

Standard Backset Mortice Lock Accessories

page 39



## **Selector® 3770 MKII Series Function Guides**

Function Chart, Synergy® Conversion Chart and Functioning Matrix

page 45



## **Selector® 3780 MKI Series**

Short Backset Mortice Locks

page 49

# Contents



## **Selector® 3782**

Short Backset Escape Locks

page 52



## **Selector® 3784**

Short Backset Combination Locks

page 57



## **Selector® 3787**

Short Backset Dual Entry Locks

page 62



## **Selector® 3782 DX Digital**

Short Backset DX Digital Mortice Locks

page 65



## **Selector® 3782 DX Digital**

Short Backset Key Override DX Digital Series

page 68



## **Selector® 3780 Series Accessories**

Short Backset Mortice Lock Accessories

page 71



## **Selector® 3780 Series Function Guides**

Function Chart, Synergy Conversion Chart and Functioning Matrix

page 78



# Selector<sup>®</sup> 3770 MKII Series Mortice Locks

# Selector® 3770 MKII Series Cylinder Mortice Locks

## Advantages

In the spirit of continuous improvement, the Selector 3770 Series MkII Mortice lock range is the latest step in the evolution of the Selector mortice lock. This upgrade allows for more applications of the Selector mortice lock such as use with the Fluid Panic Exit Device. And while the both the Selector Series mortice locks (MkI) and the new MkII perform particularly well against the Australian Standard, the MkII is a further improvement over MkI when it comes to the list of non-standard tests which ASSA ABLOY Australia performs on these locks. The non-standard list of tests reflect real world treatment of mortice locks over and above that contained in the Australian Standard and are based on the extensive experience ASSA ABLOY Opening Solutions has with mortice locks. For example, we have tested applying loads on bolts while the latch is being retracted. ASSA ABLOY Opening Solutions conducts tests beyond the Australia Standard up to the point of destruction to identify failure modes, to prevent access under these conditions.

## Difference

The embossed dot on the underside of the auxiliary bolt of the Selector MkII for the 60mm version. This will identify the installed Selector mortice lock as a MkII lock.

The main bolt hole shape in the faceplate has changed for MkII. This can be seen when the cover plate is removed. This is used to identify the installed MkII mortice lock for the 89mm and 127mm backset versions.

## Application

A comprehensive range of cylinder mortice locks suitable for heavy duty use in industrial and commercial buildings, institutions, clubs, schools, hospitals, hotels and similar buildings.

## Benefits

- Easy red/green function setting
- All lock settings are made from under the faceplate allowing for simple in-door configuration
- Standard primary locks include anti-lockout and holdback capabilities
- Improved cylinder functions including lock/unlock and retract latch as standard
- Through-fixing of rose furniture turnknobs and escutcheons
- Reduced range of cylinder cams and turn adaptors relative to other commonly available commercial cylinder mortice locks

## Features and Specifications

The Australian designed and made Selector® 3770 Series Cylinder Mortice Locks are made from quality materials to meet high durability and strength requirements.

## Case and Faceplates

- High purity zinc alloy material cases with stainless steel chassis plates. Stainless steel faceplates provided as standard.
- Brass faceplates available for alternative finishes

## Backset

- 60mm standard backset
- Extended backsets 89mm and 127mm are available - Refer to Function Matrix (Page 43)

## Latch Bolts

- Latch bolts are made with stainless steel, 15mm in size
- Deadlatching is achieved by an auxiliary stainless steel latch bolt
- Reversible for both left and right hand doors, opening in or opening out whilst lock is in door
- Electric Strike compatibility
- Separate auxiliary bolt moves into lock case simultaneously with latch bolt
- Radius bolt provides greater deadlatch throw and smoother closing action

## Cylinder Retaining Pin

Hard-drawn spring steel wire, corrosion protected.

## Door Thickness

- 32mm to 50mm

Components to facilitate use on thicker doors are available on application.

## Door Clearance

To ensure correct functioning of the deadlatching mechanism and security for all locks, the clearance between the door and the frame should be 3mm. The deadlatching will operate up to 7mm door clearance however, door clearances over 5mm are not recommended.

## Aluminium Doors

Specify Selector® 3772-AFKIT for aluminium door fixing kit to convert a timber fix lock to suit aluminium door fixing. The aluminium door fixing kit comes with a 156mm by 25mm radius corner faceplate common to other aluminium door locks.

## Security

All Selector® 3770 Series Cylinder Mortice Locks conform with Level S7 (Physical Security) Australian Lock Standard (AS-4145.2-2008). Conforms to Level S8 (Physical Security) when fitted with door furniture and anti-drill cylinder.

## Durability

All Selector® 3770 Series Cylinder Mortice Locks conform with Level D8 (Durability) Australian Lock Standard (AS 4145.2-2008).

## Fire Rating

All Selector® 3770 Series Mortice Locks have been successfully tested up to 4 hours (depending on type of doorset) on fire door assemblies in accordance with Australian Standard AS 1905.1-2005, Part 1: Fire Resistant Doorsets\*.

# Selector® 3770 MKII Series Cylinder Mortice Locks

## Anti-Corrosion

All Selector® 3770 Series Cylinder Mortice Locks conform with Level C6 (168 hours) Australian Lock Standard (AS4145.2-2008).

## Cylinder

Requires standard Lockwood oval shaped brass cylinders and brass barrels. Lockwood cylinders include bump resistant five pin tumbler mechanism.

Functions require the use of different cams and adaptors.

## Keying

### Restricted Special Keying

Lockwood locks can be keyed to a number of controlled and/or specially keyed systems. These range from legally protected keys to protect against unauthorised duplication and can also include specially designed keying systems such as master key systems. This allows for different levels of mechanical access control.

Please refer to [assaabloy.com.au](http://assaabloy.com.au) for keying systems or contact your local sales office or customer service for specific information.

## Standard Finishes

Stainless Steel SS

## Extended Cylinders

Modular Cylinder Extensions are available for thicker doors.

## Rebate

Rebate kits to suit 13mm standard rebate are available.

## Electric Strikes

Lockwood offers a wide range of electric strikes which are compatible with the Selector® 3770 Series Mortice Locks. Refer to [lockweb.com.au](http://lockweb.com.au) for further details.

 **HIGH SECURITY**

 **DURABILITY**

 **FIRE RATED**

 **ANTI-CORROSION**

### Note:

\*For questions concerning our fire rated products, their specifications and their utilization please contact ASSA ABLOY or relevant Fire Door Manufacturer.

All dimensions depicted in this brochure are in mm.

# Selector® 3770 MkII Series Cylinder Mortice Locks

## 1. Multi-function Lock

The new Selector® 3770 MkII Series Mortice Lock was designed to incorporate the full range of lock functions into one primary lock. This reduces stock line items. All functions can be configured by adjusting the hub setting selector, lock function selector as well as using cylinder cams and turn adaptors.

## 2. Hub Setting Selection

Hub setting can be adjusted via the Selector® 3770 MkII Series hub selector located under the faceplate of the mortice lock. The hub setting allows for three functions: Passage, Combination, or Escape function.

This is done by rotating the dial with a 4mm flat blade screwdriver.

RED - Handle is lockable. Only opened by handle when locking bar is unlocked (up).

GREEN - Opened by handle at all times.

## 3. Lock Function Setting

The new Selector® 3770 MKII Series Mortice Lock was designed to incorporate a greater range of lock functions into one primary lock. In addition to anti-lockout setting, the Selector® 3770 MKII Series also includes an industry first selectable holdback feature.

N - Neutral Lock  
Factory default  
Lock operates as a standard lock

A - Anti-lockout Lock  
Closing the door or retracting the latch bolt unlocks the lock, preventing lockout situations.

H - Holdback Lock  
Latch bolt can be held within the lock.

**Holdback must not be activated on fire doors.**

## 4. Backset

Standard backset - 60mm. Extended backsets 89mm and 127mm are available

## 5. Case Assembly

Zinc diecast body with stainless steel chassis plates for improved strength.

## 6. Furniture Through Fix Holes

Through fixed escutcheons and turnknobs can now be used with the lock, allowing for more robust fixing of door furniture.

## 7. Cylinder/Adaptor Retention

"Slip Pin" Cylinder/Adaptor fixing method, which allows attachment to the case by inserting a non-threaded cylindrical pin through the front of the lock case.

## 8. Cylinder Assembly

Five pin tumbler mechanism. Standard Lockwood oval shaped, brass cylinders and brass barrels. Only two newly designed cams needed for all lock functions.

X7 Cam - Retracts latch bolt with additional ability of locking the locking bar.

V Cam - Locks and unlocks the locking bar. Also retracts latch bolt after unlocking lock.

## 9. Synergy Retrofit

The Selector® 3770 MkII Series Mortice Lock is designed to have an equivalent case size as the Synergy Series Mortice Lock to ensure retrofitability.

## 10. Kits

The Selector® 3770 MkII Series primary lock is designed for timber doors. Various kit conversions are available for aluminium door applications, alternative finishes as well as dual entry and DX digital locksets.

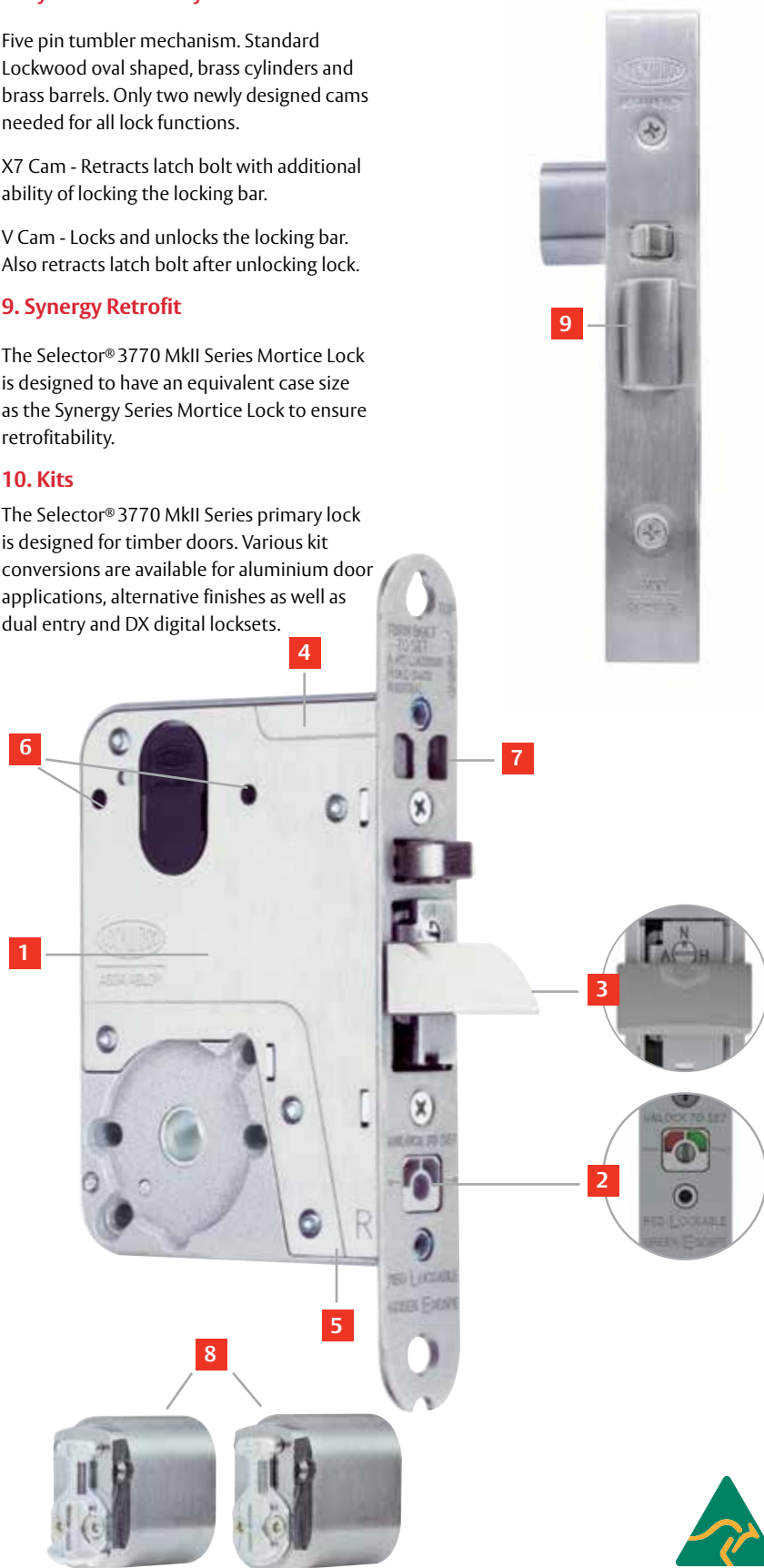



# Selector<sup>®</sup> 3770 MKII Mortice Nightlatches



## Description

These locks have various latching functions operated by a key outside and by a turnknob or key inside. The mortice nightlatch locks automatically when the door is closed.

## Product Details

<b>Backset</b>	Available in 60, 89 and 127mm backsets.
<b>Furniture</b>	Compatible with most Lockwood cylinder escutcheons, turnknobs and plate furniture. Refer to <a href="http://lockweb.com.au">lockweb.com.au</a> for further details.
<b>Latch</b>	Deadlatch only.
<b>Standard</b>	Stainless Steel (SS)
<b>Finishes</b>	Other finishes available via finish kit conversions

## Important Note:

The Latching Adaptor for Selector 3770 Series MkII is not backwards compatible. Therefore, 3770M1-ADAPTOR **MUST** be used for Selector Mortice Lock MkI and 3770M2-ADAPTOR **MUST** be used for Selector Mortice Lock MkII.

# Selector® 3770 MKII Mortice Nightlatches

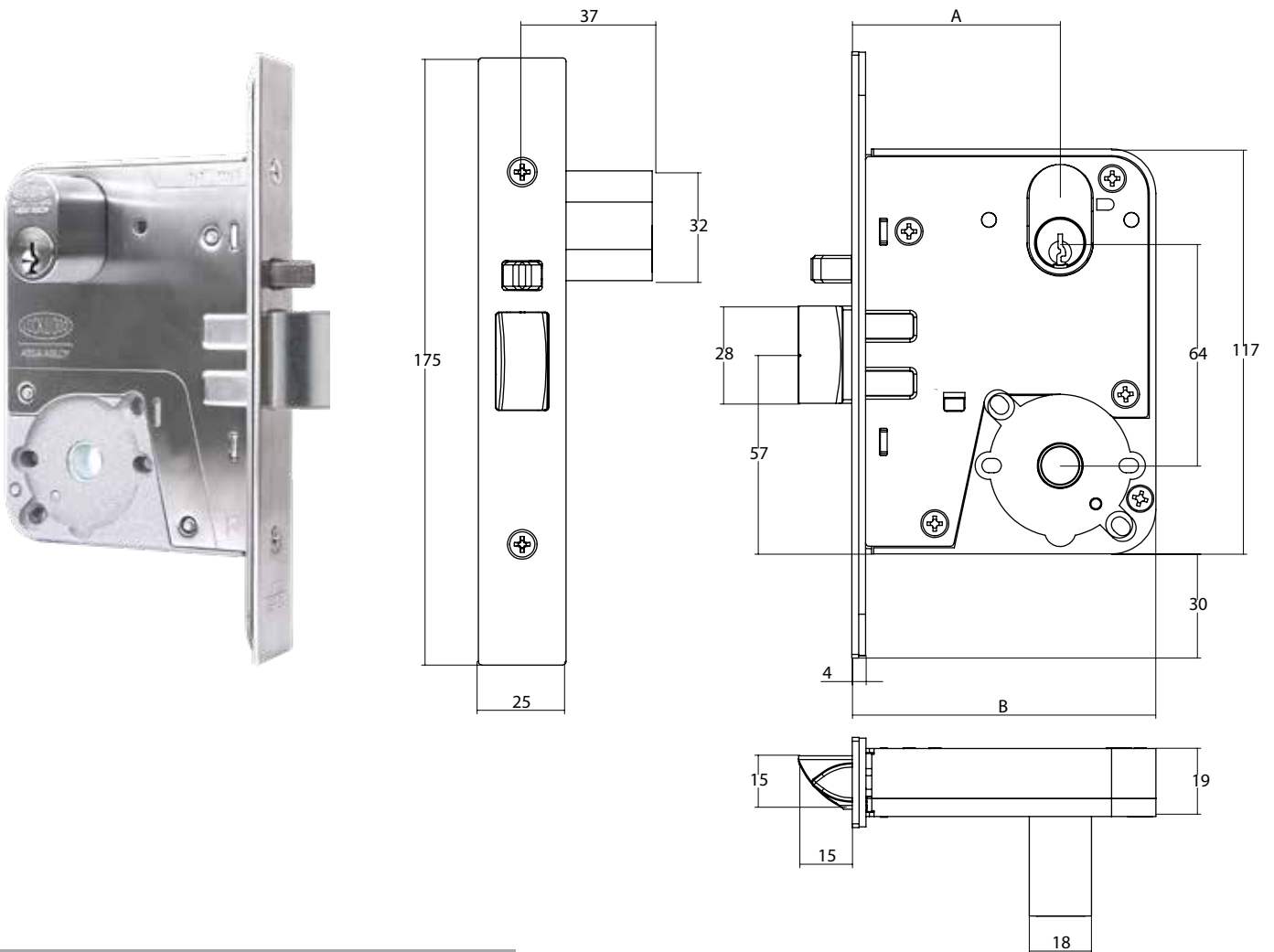

## Selector® 3770 Mortice Nightlatches

Part Number	3770	4770	5770
Dimension A	60	89	127
Dimension B	88	117	155

Note: 3772SS Primary Lock can be used to achieve 3770 functions.

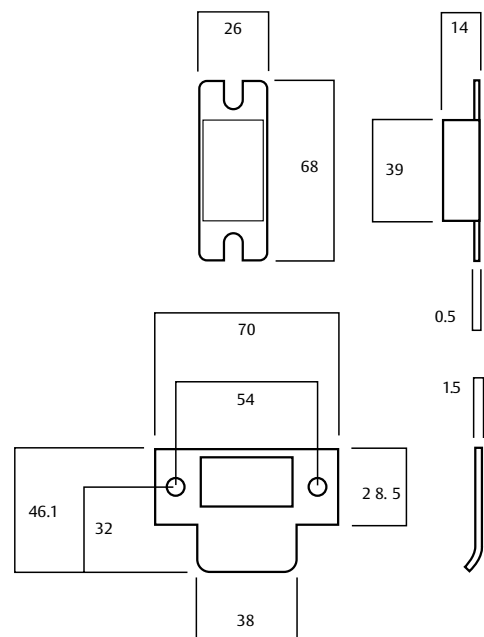

# Selector<sup>®</sup> 3770 MKII Mortice Nightlatches

## Nightlatch with Turn

**Part Number** 3770-T

Turnknob inside.

**Inside:** Opened by turnknob.

This function requires the locking bar to be positioned in the locked position once lock is set.

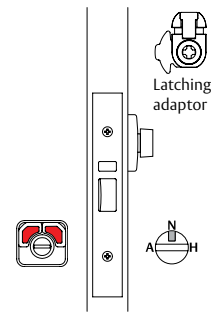

## Nightlatch with Cylinder

**Part Number** 3770X-

Single cylinder.

**Outside:** Opened by key.

This function requires the locking bar to be positioned in the locked position once lock is set.

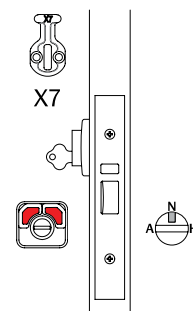

## Nightlatch with Cylinder and Turn

**Part Number** 3770XT

Cylinder and turnknob.

**Outside:** Opened by key.

**Inside:** Opened by turnknob.

This function requires the locking bar to be positioned in the locked position once lock is set.

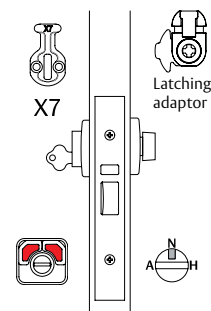

## Nightlatch with Double Cylinder

**Part Number** 3770XX

Double cylinder.

**Outside:** Opened by key.

**Inside:** Opened by key.

This function requires the locking bar to be positioned in the locked position once lock is set.

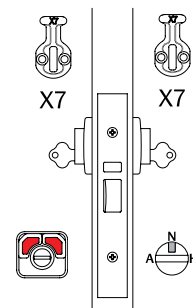

### Notes:

All drawings shown are in right hand configuration. Setting instructions only apply if 3772 is used, disregard instructions if using 3770. Part numbers shown above are for 60mm backset lock, if 89mm is required substitute 3 for 4 i.e. 4770, or if 127mm lock is required, substitute 3 for 5 i.e. 5770

### Warning:

The Latching Adaptor for Selector 3770 Series MKII is not backwards compatible. Therefore, 3770M1-ADAPTOR **MUST** be used for Selector Mortice Lock Mkl and 3770M2-ADAPTOR **MUST** be used for Selector Mortice Lock MkII.

### Legend

**Hub Setting**



**Lock Function Setting**



**Cam or Adaptor**



# Selector® 3772 MKII Escape Locks



## Description

These locks have various latching functions which can be operated by key or handle outside and by turnknob, key or handle inside.

## Product Details

<b>Backset</b>	Available in 60, 89 and 127mm backsets.
<b>Furniture</b>	Compatible with most Lockwood rose and plate furniture including Brass Door Furniture, Robert Watson Series, Artefact Series II, Ovation Series and VSR Series. Refer to <a href="http://lockweb.com.au">lockweb.com.au</a> for further details.
<b>Latch</b>	Deadlatch only.
<b>Standard</b>	Stainless Steel (SS)
<b>Finishes</b>	Other finishes available via finish kit conversions

# Selector® 3772 MKII Escape Locks

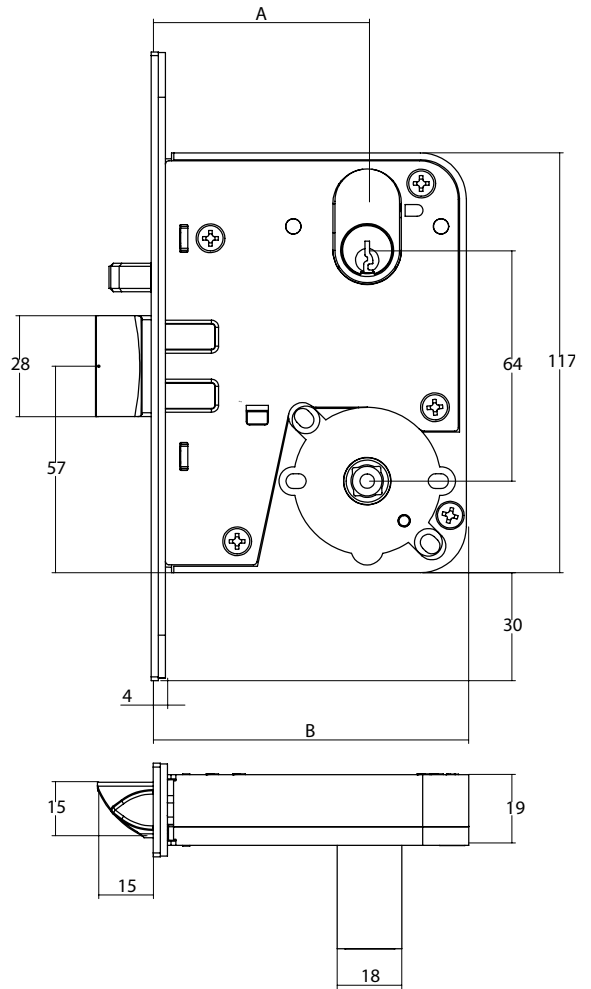
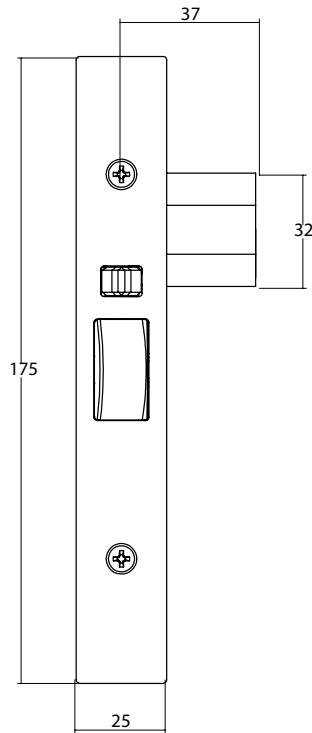

## Selector® 3772 Escape Locks

Part Number	3772	4772	5772
Dimension A	60	89	127
Dimension B	88	117	155

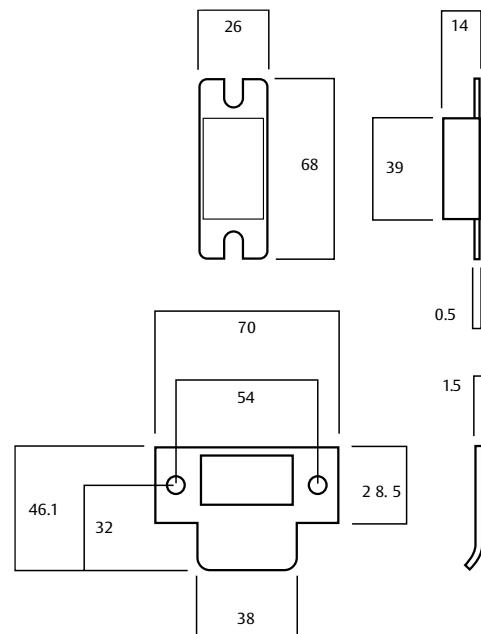

# Selector<sup>®</sup> 3772 MKII Escape Locks

## Escape Lock

**Part Number** 3772--

**Outside:** Handle always rigid.

**Inside:** Opened by handle at all times.

This function requires the locking bar to be positioned in the locked position once lock is set.

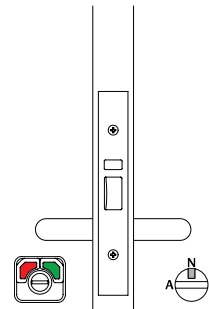

## Anti-vandal Escape Lock

**Part Number** 3772V-

Single cylinder.

**Outside:** Opened by handle when unlocked. Key locks and unlocks outside handle and retracts bolt after unlocking lock.

**Inside:** Opened by handles at all times.

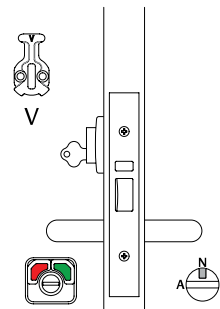

## Anti-vandal Escape Lock with Turn

**Part Number** 3772VT

Cylinder and turnknob.

**Outside:** Opened by handle when unlocked. Key locks and unlocks outside handle and retracts bolt after unlocking lock.

**Inside:** Opened by handle at all times. Turnknob locks or unlocks outside handle.

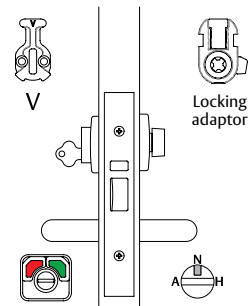

## Key Entry Escape Lock

**Part Number** 3772X-

Single cylinder.

**Outside:** Opened by key at all times. Handle always rigid.

**Inside:** Opened by handle at all times.

This function requires the locking bar to be positioned in the locked position once lock is set.

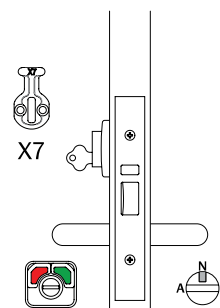

### Notes:

All drawings shown are in right hand configuration. Part numbers shown above are for 60mm backset lock, if 89mm is required substitute 3 for 4 i.e. 4772, or if 127mm lock is required, substitute 3 for 5 i.e. 5772

### Legend

**Hub Setting**



**Lock Function Setting**



**Cam or Adaptor**



# Selector<sup>®</sup> 3772 MKII Escape Locks

## Key Entry Escape Lock with Turn

**Part Number** 3772XT

Cylinder and turnknob.

**Outside:** Opened by key at all times. Opened by handle when unlocked. Key locks outside handle.

**Inside:** Opened by handle at all times. Turnknob locks or unlocks outside handle.

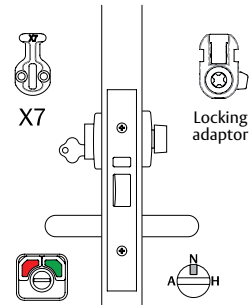

## Escape Lock with Internal Cylinder

**Part Number** 3772-V

Single cylinder.

**Outside:** Opened by handle when unlocked.

**Inside:** Opened by handle at all times. Key locks or unlocks outside handle and retracts bolt after unlocking lock.

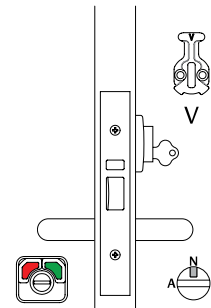

## Escape Lock with Turn

**Part Number** 3772-T

Turnknob inside.

**Outside:** Opened by handle when unlocked.

**Inside:** Opened by handle at all times. Turnknob locks or unlocks outside handle.

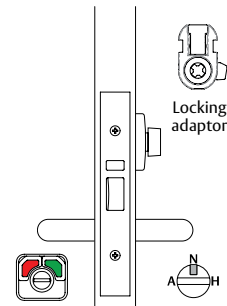

## Anti-vandal Escape Lock with Internal Cylinder

**Part Number** 3772VV

Double Cylinder.

**Outside:** Opened by handle when unlocked. Key locks or unlocks outside handle and retracts bolt after unlocking lock.

**Inside:** Opened by handle at all times. Key locks or unlocks outside handle and retracts bolt after unlocking lock.

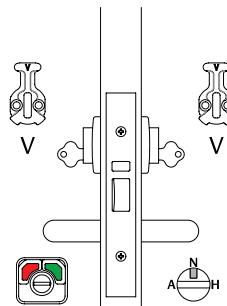

### Notes:

All drawings shown are in right hand configuration. Part numbers shown above are for 60mm backset lock, if 89mm is required substitute 3 for 4 i.e. 4772, or if 127mm lock is required, substitute 3 for 5 i.e. 5772

### Legend

**Hub Setting**



**Lock Function Setting**



**Cam or Adaptor**



# Selector® 3772 MKII Escape Locks

## Key Entry Escape Lock with Internal Cylinder

**Part Number** 3772XV

Double cylinder.

**Outside:** Opened by key at all times. Opened by handle when unlocked. Key locks outside handle.

**Inside:** Opened by handle at all times. Key locks or unlocks outside handle and retracts bolt after unlocking lock.

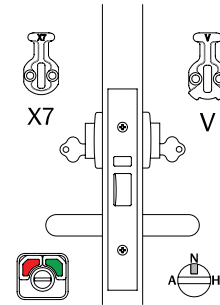

## Anti-lockout Escape Lock with Turn\*

**Part Number** 3772-TA

Turnknob inside.

**Outside:** Opened by handle when unlocked.

**Inside:** Opened by handle at all times. Turnknob locks or unlocks outside handle.

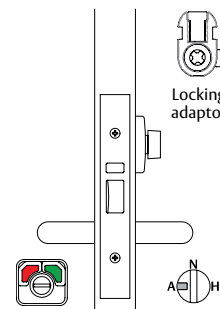

## Anti-lockout Anti-vandal Escape Lock with Turn\*

**Part Number** 3772VTA

Cylinder and turnknob.

**Outside:** Opened by handle when unlocked. Key locks or unlocks outside handle and retracts bolt after unlocking lock.

**Inside:** Opened by handle at all times. Turnknob locks or unlocks outside handle.

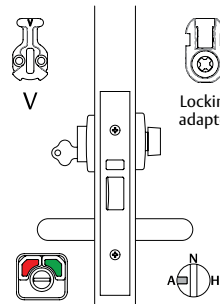

## Holdback Anti-vandal Escape Lock#

**Part Number** 3772V-H

Single cylinder.

**Outside:** Opened by handle when unlocked. Key locks or unlocks outside handle and retracts bolt after unlocking lock.

**Inside:** Opened by handle at all times.

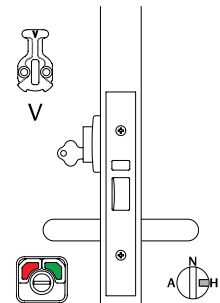

### Notes:

All drawings shown are in right hand configuration. Part numbers shown above are for 60mm backset lock, if 89mm is required substitute 3 for 4 i.e. 4772, or if 127mm lock is required, substitute 3 for 5 i.e. 5772

\*Anti-lockout - Closing the door or retracting latch bolt unlocks the lock, preventing lockout situations.

# Holdback - Latch bolt can be held within the lock. **Holdback must not be activated on fire doors.**

For questions concerning our fire rated products, their specifications and their utilization please contact ASSA ABLOY or relevant Fire Door manufacturer.

### Legend

**Hub Setting**



**Lock Function Setting**



**Cam or Adaptor**





# Selector<sup>®</sup> 3772 MKII Escape Locks

## Holdback Anti-vandal Escape Lock with Turn<sup>#</sup>

**Part Number** 3772VTH

Cylinder and turnknob.

**Outside:** Opened by handle when unlocked. Key locks or unlocks outside handle and retracts bolt after unlocking lock.

**Inside:** Opened by handle at all times. Turnknob locks or unlocks outside handle.

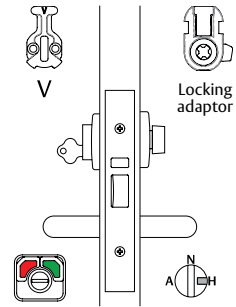

## Holdback Key Entry Escape Lock with Internal Cylinder<sup>#</sup>

**Part Number** 3772XVH

Double cylinder.

**Outside:** Opened by key at all times. Opened by handle when unlocked. Key locks outside handle.

**Inside:** Opened by handle at all times. Key locks or unlocks outside handle and retracts bolt after unlocking lock.

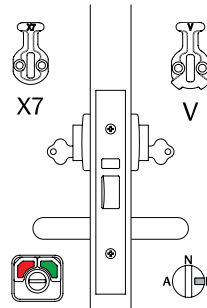

### Notes:

All drawings shown are in right hand configuration.

Part numbers shown above are for 60mm backset lock, if 89mm is required substitute 3 for 4 i.e. 4772, or if 127mm lock is required, substitute 3 for 5 i.e. 5772

\*Anti-lockout - Closing the door or retracting latch bolt unlocks the lock, preventing lockout situations.

#Holdback - Latch bolt can be held within the lock. **Holdback must not be activated on fire doors.**

For questions concerning our fire rated products, their specifications and their utilization please contact ASSA ABLOY or relevant Fire Door manufacturer.

### Legend

**Hub Setting**



**Lock Function Setting**



**Cam or Adaptor**



# Selector® 3774 MKII Passage Latch



## Description

The Passage latch only has a plainlatch. It allows operation of outside and inside handles at all times with no locking functions. Ideal for interconnecting doors.

## Product Details

<b>Backset</b>	Available in 60, 89 and 127mm backsets.
<b>Furniture</b>	Compatible with most Lockwood rose and plate furniture including Brass Door Furniture, Robert Watson Series, Artefact Series II, Ovation Series and VSR Series. Refer to <a href="http://lockweb.com.au">lockweb.com.au</a> for further details.
<b>Latch</b>	Plainlatch only
<b>Standard Finishes</b>	Stainless Steel (SS) Other finishes available via finish kit conversions.

# Selector® 3774 MKII Passage Latch

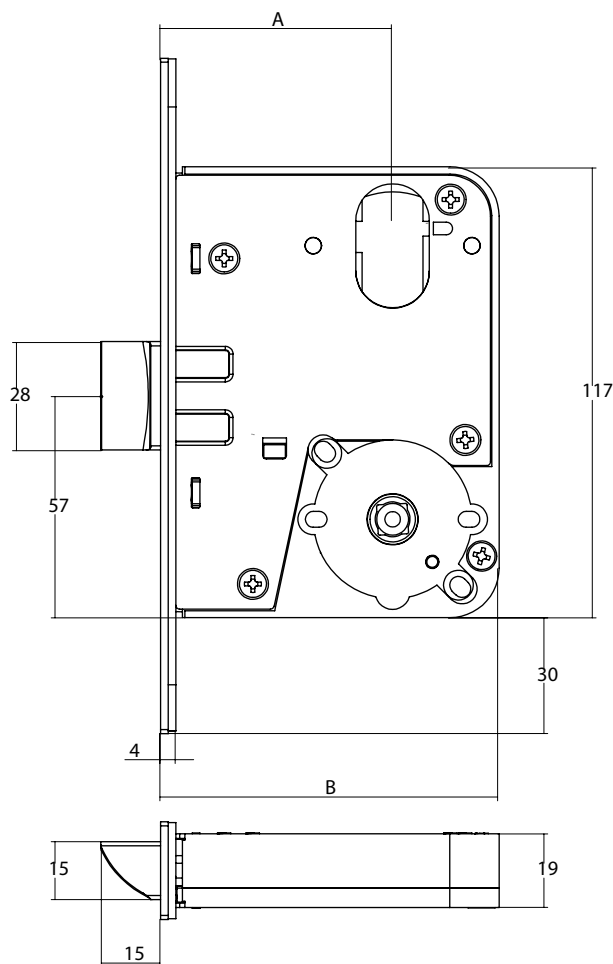
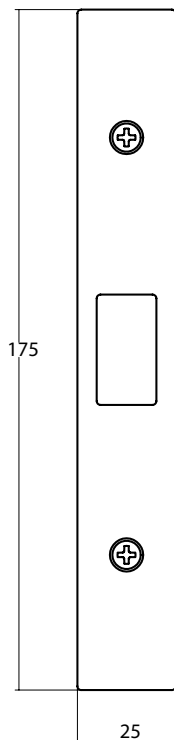

## Selector® 3774 Passage Latch

Part Number	3774	4774	5774
Dimension A	60	89	127
Dimension B	88	117	155

**Note:** Passage Latch primary lock only available in 60mm backset (3774). For extended backset options, please order 4772/5772 primary lock and configure accordingly.

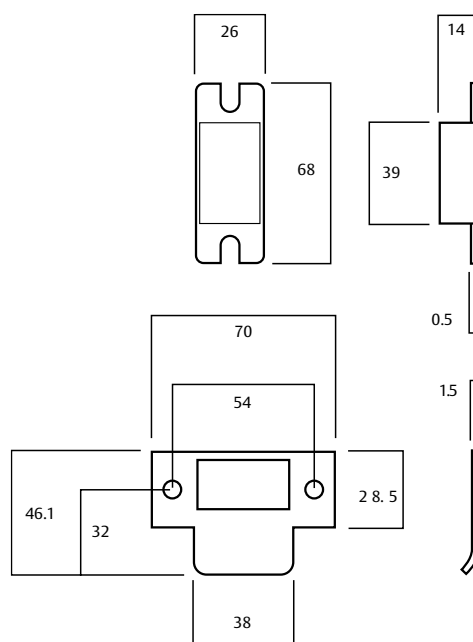

# Selector® 3774 MKII Passage Latch

## Passage Latch

**Part Number** 3774

No locking function. Plainlatch only.

**Outside:** Opened by handle at all times.

**Inside:** Opened by handle at all times.

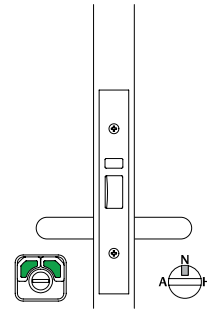

### Notes:

Setting instructions only apply if 3772 is used, disregard instructions if using 3774.

All drawings shown are in right hand configuration.

Part numbers shown above are for 60mm backset lock, if 89mm is required substitute 3 for 4 i.e. 4772, or if 127mm lock is required, substitute 3 for 5 i.e. 5772

### Legend

**Hub Setting**



**Lock Function Setting**



**Cam or Adaptor**



# Selector® 3774 MKII Combination Locks



## Description

These locks have various latching functions operated generally by outside or inside handles, except when locked by key outside or by key or turnknob inside.

## Product Details

<b>Backset</b>	Available in 60, 89 and 127mm backsets.
<b>Furniture</b>	Compatible with most Lockwood rose and plate furniture including Brass Door Furniture, Robert Watson Series, Artefact Series II, Ovation Series and VSR Series. Refer to <a href="http://lockweb.com.au">lockweb.com.au</a> for further details.
<b>Latch</b>	Deadlatch only.
<b>Standard Finishes</b>	Stainless Steel (SS) Other finishes available via finish kit conversions.

# Selector® 3774 MKII Combination Locks

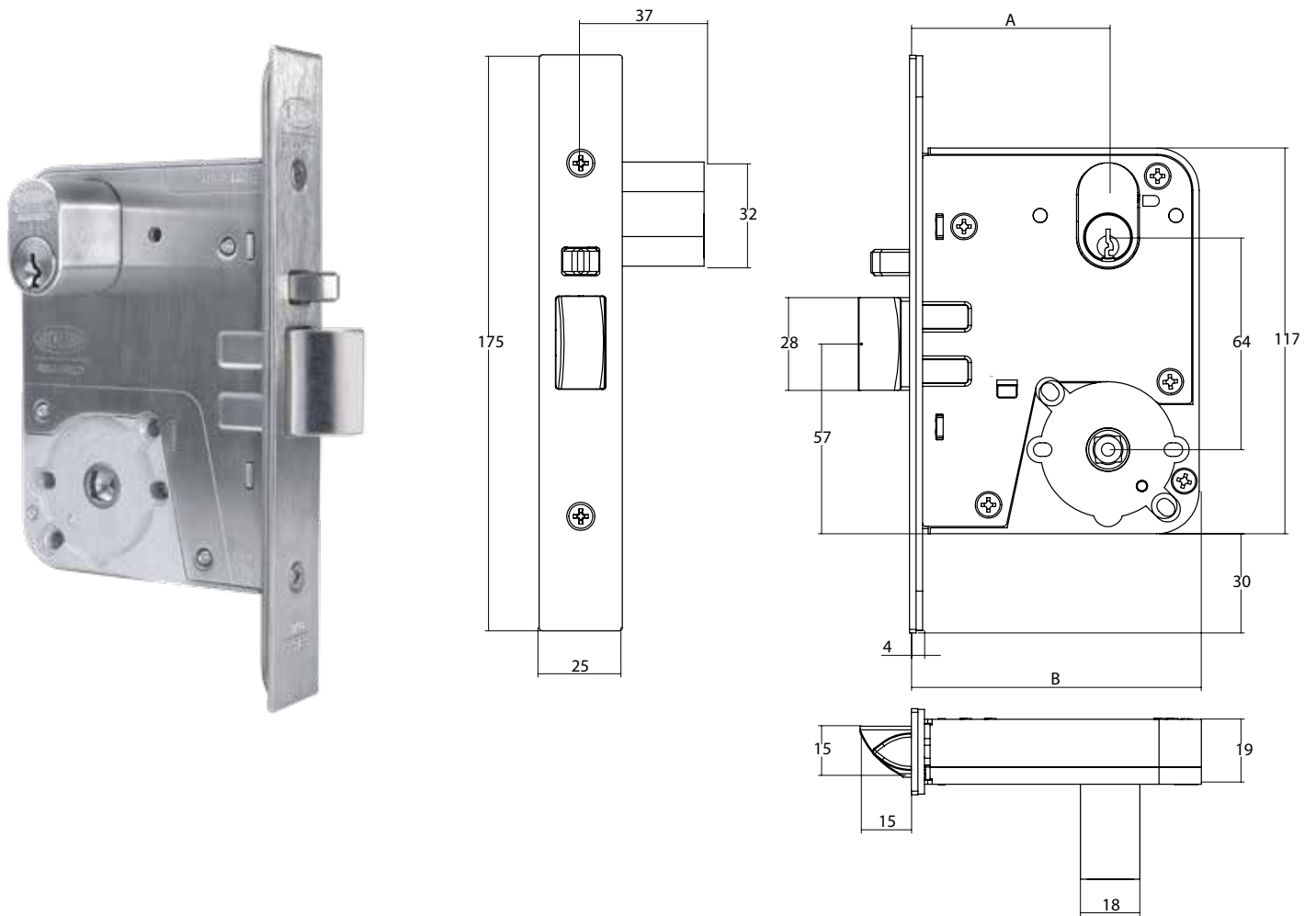

## Selector® 3774 Combintion Locks

Part Number	3774	4774	5774
Dimension A	60	89	127
Dimension B	88	117	155

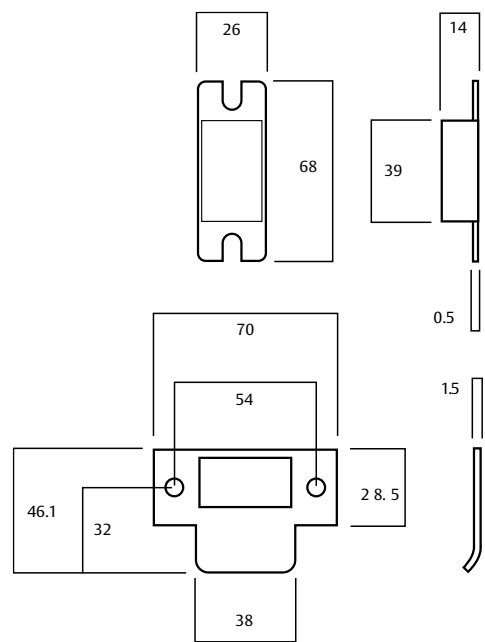

# Selector® 3774 MKII Combination Locks

## Anti-vandal Lock with Turn

**Part Number** 3774VT

Cylinder and turnknob.

**Outside:** Opened by handle when unlocked. Key locks or unlocks both handles and retracts bolt after unlocking lock.

**Inside:** Opened by handle when unlocked. Turnknob locks or unlocks both handles.

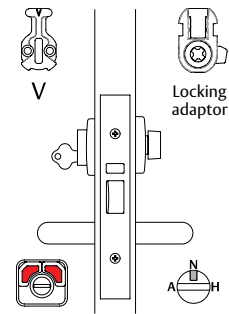

## Anti-vandal Lock with Internal Cylinder

**Part Number** 3774W

Double cylinder.

**Outside:** Opened by handle when unlocked. Key locks or unlocks both handles and retracts bolt after unlocking lock.

**Inside:** Opened by handle when unlocked. Key locks or unlocks both handles and retracts bolt after unlocking lock.

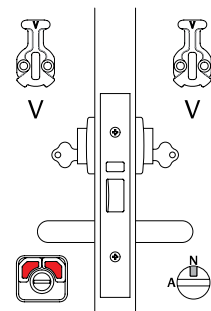

## Key Entry Lock with Internal Cylinder

**Part Number** 3774XV

Double Cylinder.

**Outside:** Opened by key at all times. Opened by handle when unlocked. Key locks both handles.

**Inside:** Opened by handle when unlocked. Key locks or unlocks both handles and retracts bolt after unlocking lock.

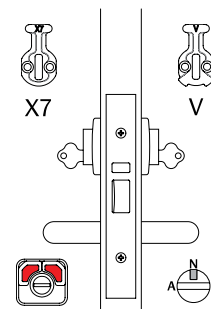

**Notes:**

All drawings shown are in right hand configuration. Part numbers shown above are for 60mm backset lock, if 89mm is required substitute 3 for 4 i.e. 4774, or if 127mm lock is required, substitute 3 for 5 i.e. 5774

Legend	
Hub Setting	
Lock Function Setting	
Cam or Adaptor	

# Selector<sup>®</sup> 3774 MKII Combination Locks

## Key Entry Double Cylinder Lock

**Part Number** 3774XX

Double cylinder.

**Outside:** Opened by key at all times. Handle always rigid.

**Inside:** Opened by key at all times. Handle always rigid.

This function requires the locking bar to be positioned in the locked position once lock is set.

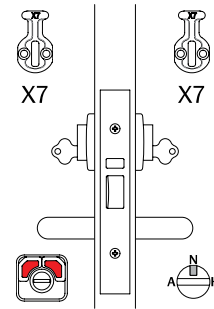

## Combination Lock with Turn

**Part Number** 3774-T

Turnknob inside.

**Outside:** Opened by handle when unlocked.

**Inside:** Opened by handle when unlocked. Turnknob locks or unlocks both handles.

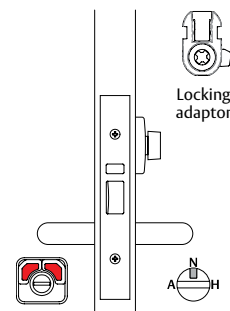

## Anti-lockout Combination Lock with Turn\*

**Part Number** 3774-TA

Turnknob inside.

**Outside:** Opened by handle when unlocked.

**Inside:** Opened by handle when unlocked. Turnknob locks or unlocks both handles.

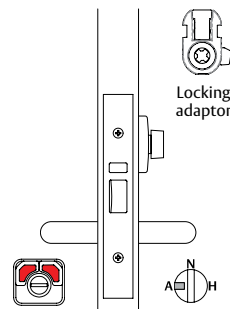

## Anti-lockout Anti-vandal Lock with Turn\*

**Part Number** 3774VTA

Cylinder and turnknob.

**Outside:** Opened by handle when unlocked. Key locks or unlocks both handles and retracts bolt after unlocking lock.

**Inside:** Opened by handle when unlocked. Turnknob locks or unlocks both handles.

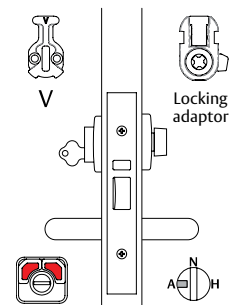

**Notes:**

All drawings shown are in right hand configuration. Part numbers shown above are for 60mm backset lock, if 89mm is required substitute 3 for 4 i.e. 4774, or if 127mm lock is required, substitute 3 for 5 i.e. 5774

\*Anti-lockout - Closing the door or retracting latch bolt unlocks the lock, preventing lockout situations.

Legend	
Hub Setting	
Lock Function Setting	
Cam or Adaptor	



# Selector<sup>®</sup> 3774 MKII Combination Locks

## Anti-lockout Anti-vandal Lock with Internal Cylinder\*

**Part Number** 3774VVA

Double cylinder.

**Outside:** Opened by handle when unlocked. Key locks or unlocks both handles and retracts bolt after unlocking lock.

**Inside:** Opened by handle when unlocked. Key locks or unlocks both handles and retracts bolt after unlocking lock.

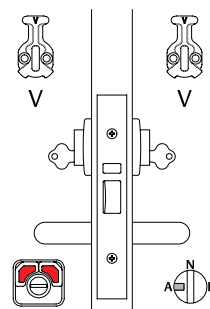

## Holdback Anti-vandal Lock with Turn#

**Part Number** 3774VTH

Cylinder and turnknob.

**Outside:** Opened by handle when unlocked. Key locks or unlocks both handles and retracts bolt after unlocking lock.

**Inside:** Opened by handle when unlocked. Turnknob locks or unlocks both handles.

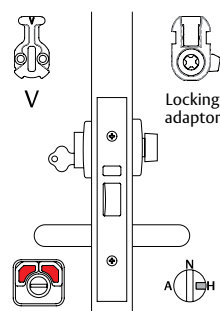

## Holdback Anti-vandal Lock with Internal Cylinder#

**Part Number** 3774VVH

Double cylinder.

**Outside:** Opened by handle when unlocked. Key locks or unlocks both handles and retracts bolt after unlocking lock.

**Inside:** Opened by handle when unlocked. Key locks or unlocks both handles and retracts bolt after unlocking lock.

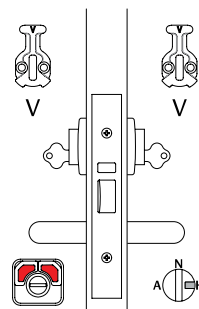

## Holdback Key Entry Lock with Internal Cylinder#

**Part Number** 3774XVH

Double cylinder.

**Outside:** Opened by key at all times. Opened by handle when unlocked. Key locks both handles.

**Inside:** Opened by handle when unlocked. Key locks or unlocks both handles and retracts bolt after unlocking lock.

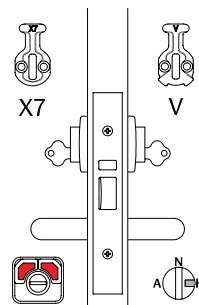

### Notes:

All drawings shown are in right hand configuration. Part numbers shown above are for 60mm backset lock, if 89mm is required substitute 3 for 4 i.e. 4774, or if 127mm lock is required, substitute 3 for 5 i.e. 5774

\*Anti-lockout - Closing the door or retracting latch bolt unlocks the lock, preventing lockout situations.

#Holdback - Latch bolt can be held within the lock. **Holdback must not be activated on fire doors.**

For questions concerning our fire rated products, their specifications and their utilization please contact ASSA ABLOY or relevant Fire Door manufacturer.

### Legend

**Hub Setting**



**Lock Function Setting**



**Cam or Adaptor**



# Selector® 3777 MKII Dual Entry Locks



## Description

Designed to enable third parties such as emergency services to enter specific areas by second cylinder; without giving access to all locksets in the building and the ability to lockout keys with restricted access at certain times.

## Product Details

### Furniture

Select from Lockwood 1800, 2800 or Artefact Series II ranges. Refer to [lockweb.com.au](http://lockweb.com.au) for further details.

### Standard Finishes

Stainless Steel (SS)  
Other finishes available via finish kit conversions

## Note:

The Selector 3770 MkII Series has a new Lower Cylinder Mounting Kit (3777-KIT) which can hold the 570E, 577 and 10,000 cylinders. For Selector 3770 MkI Series mortice locks, the 3777M1-KIT570E or 3777M1-KIT577 Lower Cylinder Mounting Kit must be ordered.

# Selector® 3777 MKII Dual Entry Locks

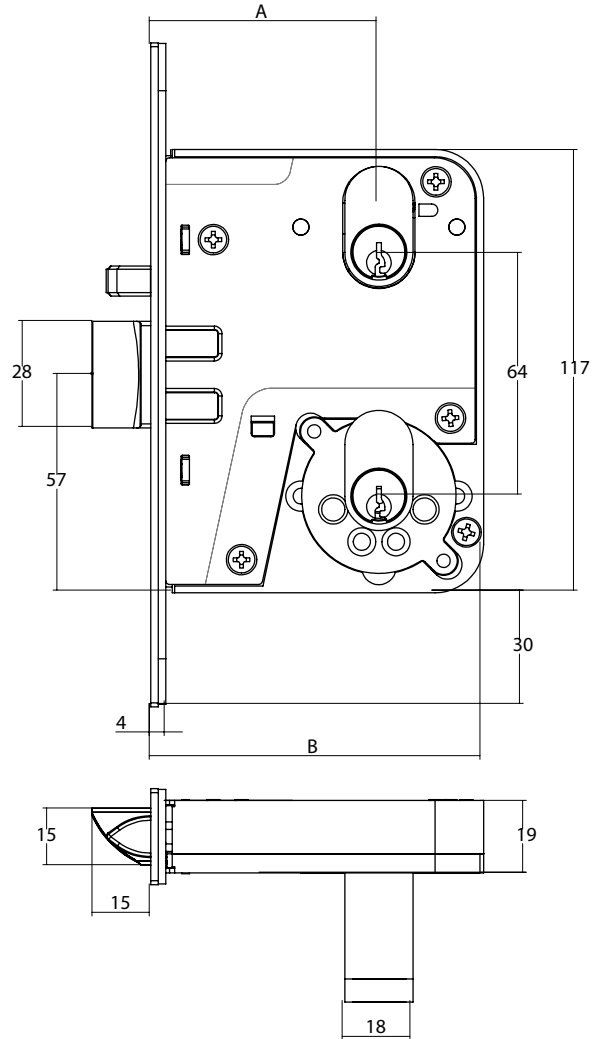
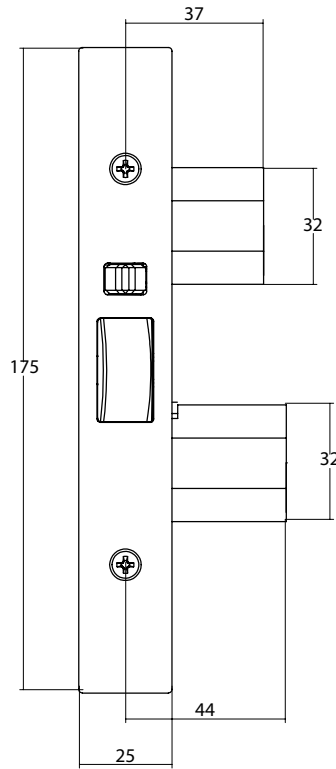

## Selector® 3777 Dual Entry Locks

Part Number	3777	4777	5777
Dimension A	60	89	127
Dimension B	88	117	155

**Note:** Order by specifying 3772SS primary lock and 3777-KIT Dual Entry Kit. Cylinders must be ordered separately.

The Selector 3770 MkII Series has a new Lower Cylinder Mounting Kit (3777-KIT) which can hold the 570E, 577 and 10,000 cylinders. For Selector 3770 MkI Series mortice locks, the 3777M1-KIT570E or 3777M1-KIT577 Lower Cylinder Mounting Kit must be ordered.

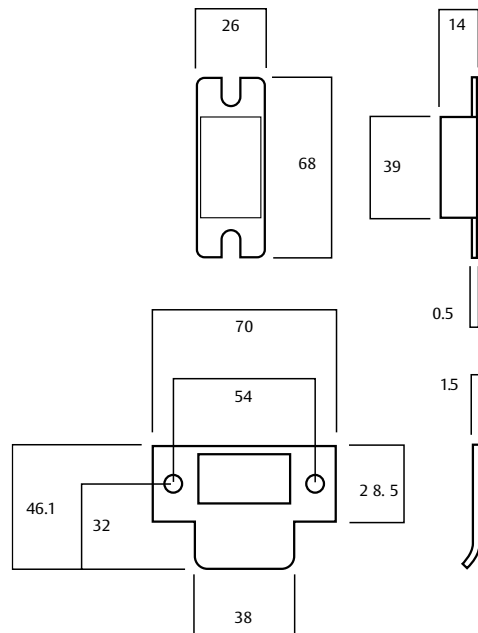

# Selector® 3777 MKII Dual Entry Locks

## Dual Entry Lock

**Part Number** 3777X-

Two cylinders outside.

**Outside:** Opened by key. Cylinders are keyed to differ.

**Inside:** Opened by handle at all times.

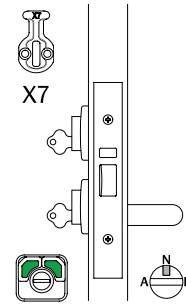

## Dual Entry Lock with Lower Cylinder Lockout

**Part Number** 3777V-

Two cylinders outside.

**Outside:** Opened by key when unlocked. Upper cylinder key locks or unlocks lower cylinder and retracts bolt after unlocking lock. Cylinders are keyed to differ.

**Inside:** Opened by handle at all times.

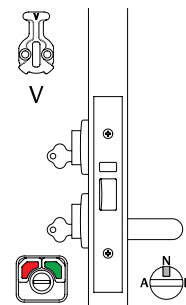

**Notes:**

All drawings shown are in right hand configuration. Part numbers shown above are for 60mm backset lock, if 89mm is required substitute 3 for 4 i.e. 4777, or if 127mm lock is required, substitute 3 for 5 i.e. 5777

\*Anti-lockout - Closing the door or retracting latch bolt unlocks the lock, preventing lockout situations.

Legend	
Hub Setting	
Lock Function Setting	
Cam or Adaptor	

# Selector<sup>®</sup> MKII Privacy Locks



## Description

Privacy locks allow doors to be unlocked from the outside via an emergency button. These locks have various latching functions which can be operated by key or handle outside and by handle inside.

## Product Details

<b>Backset</b>	Available in 60, 89 and 127mm backsets.
<b>Furniture</b>	Compatible with most Lockwood rose and plate furniture including Brass Door Furniture, Robert Watson Series, Artefact Series II, Ovation Series and VSR Series. Refer to <a href="http://lockweb.com.au">lockweb.com.au</a> for further details.
<b>Latch</b>	Deadlatch only.
<b>Standard</b>	Stainless Steel (SS)
<b>Finishes</b>	Other finishes available via finish kit conversions

# Selector<sup>®</sup> MKII Privacy Locks

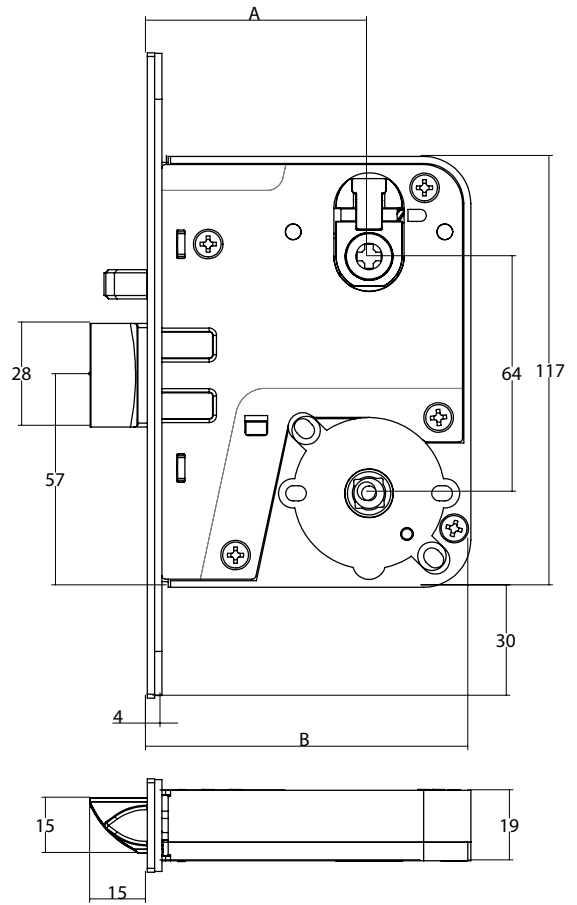
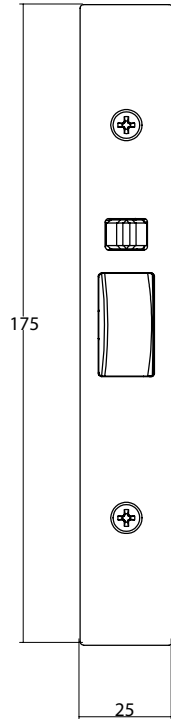

## Selector<sup>®</sup> Privacy Locks

Part Number	3772	4772	5772
Dimension A	60	89	127
Dimension B	88	117	155

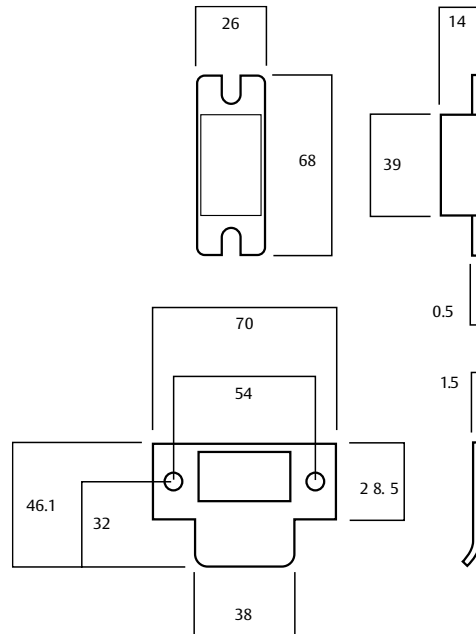

# Selector<sup>®</sup> MKII Privacy Locks

## Escape Privacy Lock

**Part Number** 3772-T

Emergency button and turnknob.

**Outside:** Opened by handle when unlocked. Emergency button locks or unlocks outside handle - operated by screwdriver or coin.

**Inside:** Opened by handle at all times. Turnknob locks or unlocks outside handle.

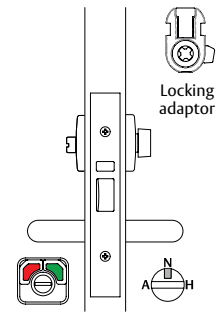

## Anti-lockout Escape Privacy Lock\*

**Part Number** 3772-TA

Emergency button and turnknob.

**Outside:** Opened by handle when unlocked. Emergency button locks or unlocks outside handle - operated by screwdriver or coin.

**Inside:** Opened by handle at all times. Turnknob locks or unlocks outside handle.

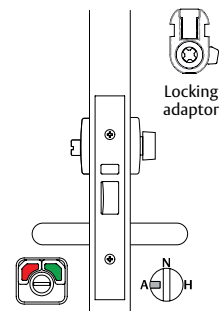

## Privacy Lock

**Part Number** 3774-T

Emergency button and turnknob.

**Outside:** Opened by handle when unlocked. Emergency button locks or unlocks both handles - operated by screwdriver or coin.

**Inside:** Opened by handle when unlocked. Turnknob locks or unlocks both handles.

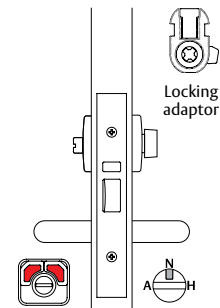

## Anti-lockout Privacy Lock\*

**Part Number** 3774-TA

Emergency button and turnknob.

**Outside:** Opened by handle when unlocked. Emergency button locks or unlocks both handles - operated by screwdriver or coin.

**Inside:** Opened by handle when unlocked. Turnknob locks or unlocks both handles.

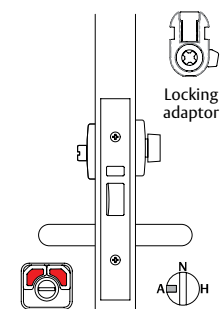

### Notes:

All drawings shown are in right hand configuration. Part numbers shown above are for 60mm backset lock, if 89mm is required substitute 3 for 4 i.e. 4772, or if 127mm lock is required, substitute 3 for 5 i.e. 5772

\*Anti-lockout - Closing the door or retracting latch bolt unlocks the lock, preventing lockout situations.

### Legend

**Hub Setting**



**Lock Function Setting**



**Cam or Adaptor**



# Selector<sup>®</sup> MKII Privacy Locks

## Key Entry Privacy Lock

**Part Number** 3777-T

Lower cylinder outside, emergency button and turnknob.

**Outside:** Opened by key when unlocked. Emergency button locks or unlocks outside key and inside handle - operated by screwdriver or coin.

**Inside:** Opened by handle when unlocked. Turnknob locks or unlocks outside key and inside handle.

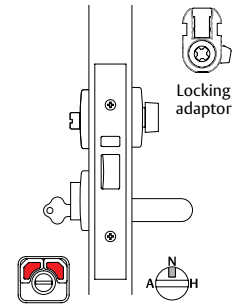

## Key Entry Anti-lockout Privacy Lock\*

**Part Number** 3777-TA

Lower cylinder outside, emergency button and turnknob.

**Outside:** Opened by key when unlocked. Emergency button locks or unlocks outside key and inside handle - operated by screwdriver or coin.

**Inside:** Opened by handle when unlocked. Turnknob locks or unlocks outside key and inside handle.

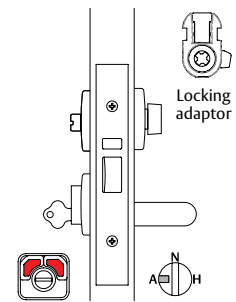

**Notes:**

All drawings shown are in right hand configuration. Part numbers shown above are for 60mm backset lock, if 89mm is required substitute 3 for 4 i.e. 4772, or if 127mm lock is required, substitute 3 for 5 i.e. 5772

\*Anti-lockout - Closing the door or retracting latch bolt unlocks the lock, preventing lockout situations.

Legend	
Hub Setting	
Lock Function Setting	
Cam or Adaptor	



# Selector<sup>®</sup> 3772 MKII DX Digital Mortice



## Description

Lockwood DX Digital Locksets provide a mechanical method of keyless entry and are designed to control access into commercial areas.

For extra security when under forced attack, the inbuilt clutching mechanism allows the outside turnknob to rotate without operating or damaging the lock.

The factory set 4 digit code is easily changed to any 4, 5 or 6 digit code using the code changing kit provided with each lock.

As the digital lockset utilizes mechanical operation, electrical wiring is not required.

## Outside Function

Press the C button, enter the correct code, then turn the turnknob to unlock the door. Upon releasing the turnknob the code is automatically cancelled.

## Warning:

The Latching Adaptor for Selector 3770 Series MkII is not backwards compatible. Therefore, 3770M1-ADAPTOR **MUST** be used for Selector Mortice Lock MkI and 3770M2-ADAPTOR **MUST** be used for Selector Mortice Lock MkII.

## Product Details

**Backset** Available in 60, 89 and 127mm backsets.

**Door Thickness** 32mm to 50mm

**Finish** Codepad: Satin Chrome Brushed (SC)  
Mortice Lock: Stainless Steel (SS)

**Codepad Assembly** High purity zinc alloy, 45mm wide, 164mm high, 52mm projection

**Latch** Stainless steel with 15mm projection

Door Furniture (Lockwood 1800 and 2800 Series) must be ordered separately.

## Inside Function

Opened by lever handle at all times.

## Holdback Function

A key operated holdback function is available as a lock setting and requires the inclusion of an internal cylinder.

# Selector® 3772 MKII DX Digital Mortice



Exterior



Interior

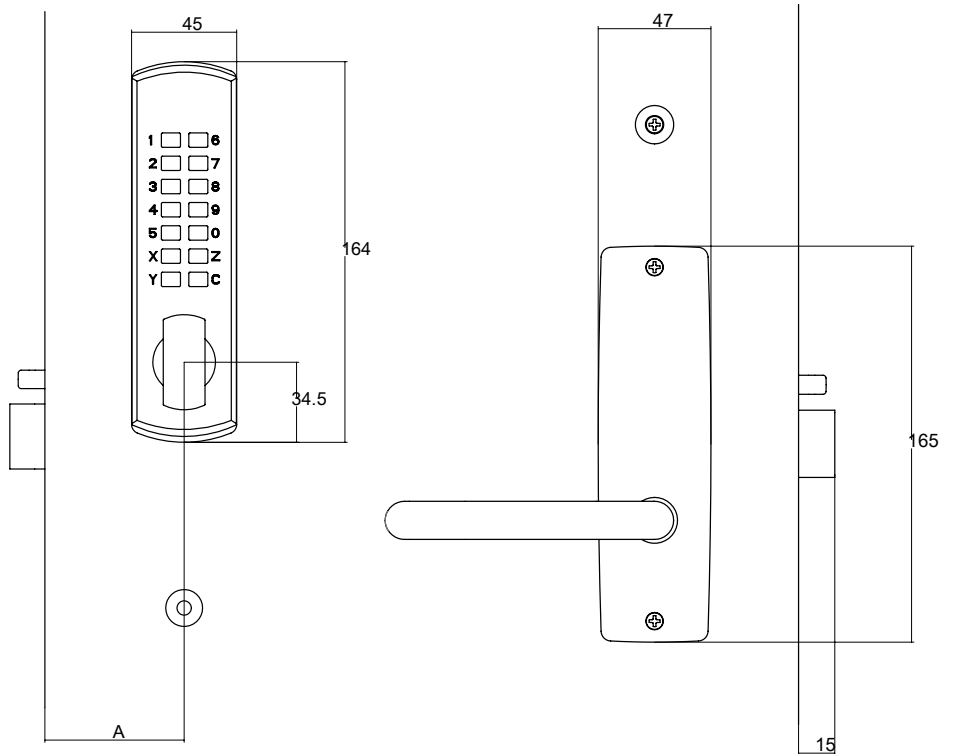

## Selector® 3772 DX Digital Mortice Locks

Part Number	3772DX	4772DX	5772DX
Dimension A	60	89	127

**Note:** Order by specifying 3772SS primary lock and 3772-DXKITSC.

For the 3772SS MKI primary lock, 3772M1-DXKITSC conversion kit must be ordered.

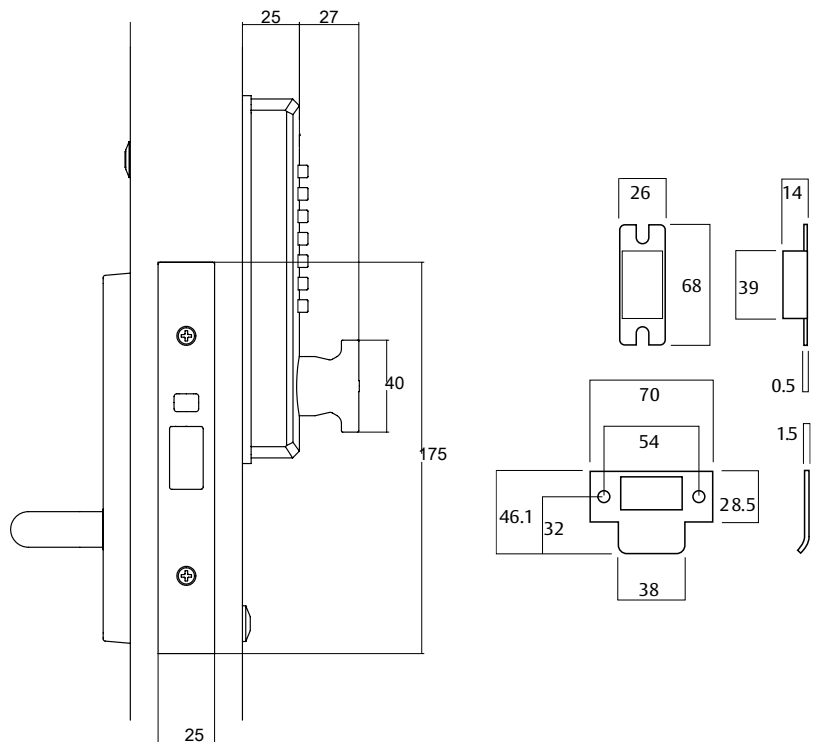

# Selector® 3772 MKII DX Digital Mortice

## DX Digital Mortice Lock

**Part Number** 3772DX-

DX Digital outside, plate furniture inside.

**Outside:** Opened by DX Digital with code.

**Inside:** Opened by handle at all times.

This function requires the locking bar to be positioned in the locked position once lock is set.

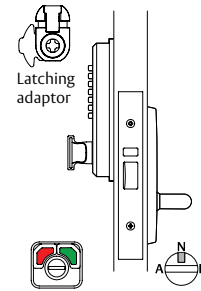

## DX Digital Mortice Lock with Holdback by Cylinder#

**Part Number** 3772DXVH

DX Digital outside, plate furniture and cylinder inside.

**Outside:** Opened by DX Digital with code.

**Inside:** Opened by handle at all times. Holdback activated by key. Key retracts latch after releasing holdback.

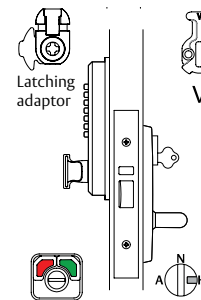

### Notes:

All drawings shown are in right hand configuration. Part numbers shown above are for 60mm backset lock, if 89mm is required substitute 3 for 4 i.e. 4772, or if 127mm lock is required, substitute 3 for 5 i.e. 5772

#Holdback - Latch bolt can be held within the lock. **Holdback must not be activated on fire doors.**

For questions concerning our fire rated products, their specifications and their utilization please contact ASSA ABLOY or relevant Fire Door manufacturer.

### Warning:

The Mkl Latching Adaptor (now part number 3770M1-ADAPTOR) can only be used with the Mkl Selector Mortice Locks and the MkII Latching Adaptor (3770M2-ADAPTOR) can only be used with MkII Selector Mortice Locks.

### Legend

**Hub Setting**



**Lock Function Setting**



**Cam or Adaptor**



# Selector® 3772 MKII Key Override DX Digital Mortice Locks



## Description

Lockwood DX Digital Locksets provide a mechanical method of keyless entry and are designed to control access into commercial areas.

For extra security when under forced attack, the inbuilt clutching mechanism allows the outside turnknob to rotate without operating or damaging the lock.

The factory set 4 digit code is easily changed to any 4, 5 or 6 digit code using the code changing kit provided with each lock.

As the digital lockset utilizes mechanical operation, electrical wiring is not required.

## Outside Function

Outside: Press the C button, enter the correct code, then turn the turnknob to unlock the door. Upon releasing the turnknob the code is automatically cancelled. The key override pin tumbler cylinder enables quick access by key for authorities such as the fire brigade or those who need to carry a master key to access all rooms of a building.

## Warning:

The Latching Adaptor for Selector 3770 Series MkII is not backwards compatible. Therefore, 3770M1-ADAPTOR **MUST** be used for Selector Mortice Lock MkI and 3770M2-ADAPTOR **MUST** be used for Selector Mortice Lock MkII.

## Product Details

<b>Backset</b>	Available in 60, 89 and 127mm backsets.
<b>Cylinder</b>	Pin tumbler mechanism with oval brass cylinder
<b>Door Thickness</b>	32mm to 50mm
<b>Finish</b>	Codepad: Satin Chrome Brushed (SC) Mortice Lock: Stainless Steel (SS)
<b>Latch</b>	Stainless steel with 15mm projection

Door Furniture (Lockwood 1800 and 2800 Series) and lower cylinder must be ordered separately.

## Inside Function

Opened by lever handle at all times.

## Holdback Function

A key operated holdback function is available as a lock setting and requires the inclusion of an internal cylinder.

# Selector® 3772 MKII Key Override DX Digital Mortise Locks



Exterior



Interior

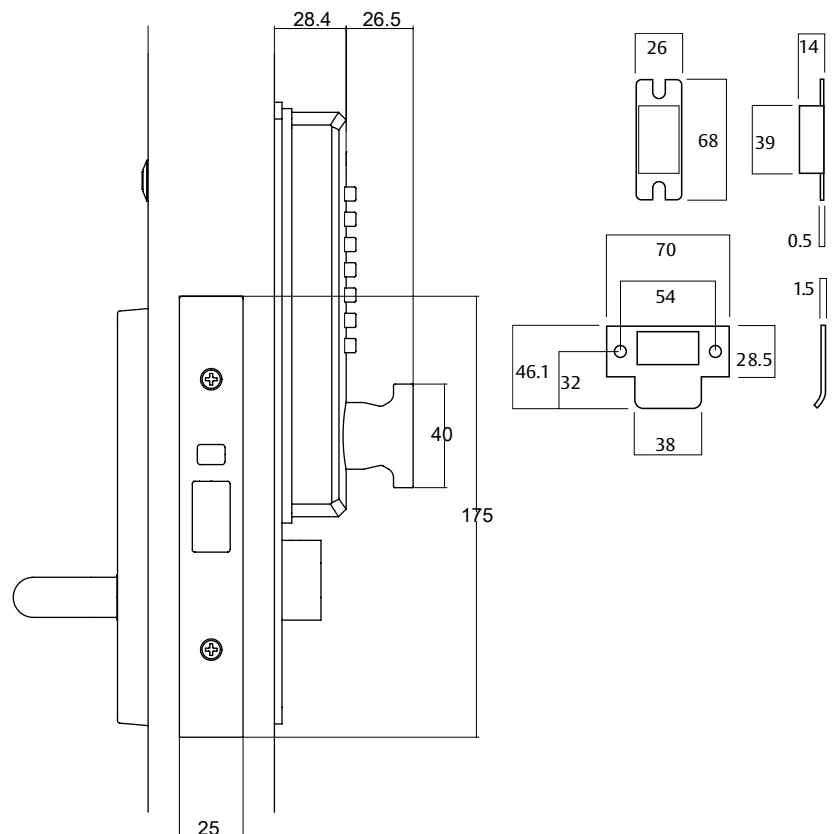
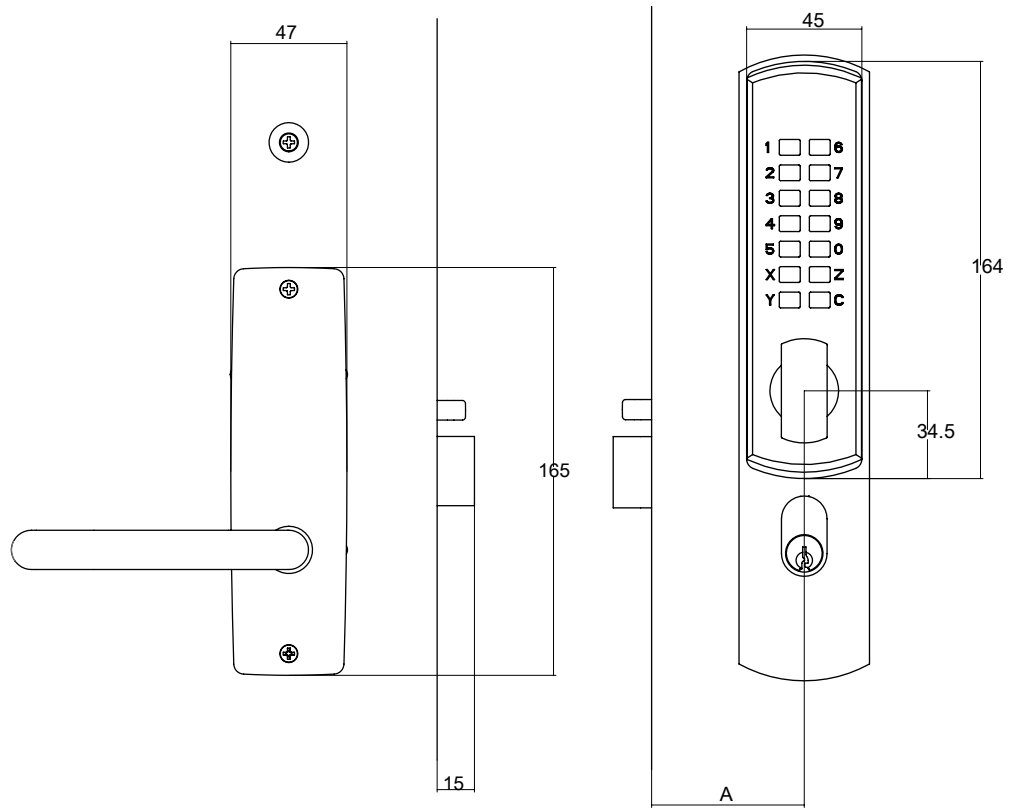

## Selector® 3772 Key Override DX Digital Mortise Locks

Part Number	3772DXKO	4772DXKO	5772DXKO
Dimension A	60	89	127

**Note:** Order by specifying 3772SS primary lock and 3772-DXKOKITSC. Cylinders must be ordered separately.

For 3772SS MkI primary lock, 3772M1-DXKOKITSC must be ordered.

# Selector® 3772 MKII Key Override DX Digital Mortise Locks

## Key Override DX Digital Mortise Lock

**Part Number** 3772DXKO-

DX Digital and lower cylinder outside, plate furniture inside.

**Outside:** Opened by DX Digital with code or key at all times.

**Inside:** Opened by handle at all times.

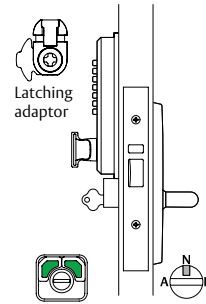

## Key Override DX Digital Mortise Lock with Holdback by Cylinder#

**Part Number** 3772DXKOVH

DX Digital and lower cylinder outside, plate furniture and cylinder inside.

**Outside:** Opened by DX Digital with code or key at all times.

**Inside:** Opened by handle at all times. Holdback activated by key. Key retracts latch after releasing holdback.

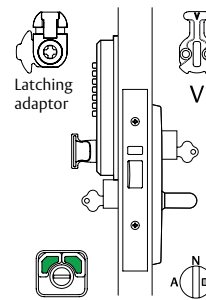

### Notes:

All drawings shown are in right hand configuration.

Part numbers shown above are for 60mm backset lock, if 89mm is required substitute 3 for 4 i.e. 4772, or if 127mm lock is required, substitute 3 for 5 i.e. 5772

#Holdback - Latch bolt can be held within the lock. **Holdback must not be activated on fire doors.** For questions concerning our fire rated products, their specifications and their utilization please contact ASSA ABLOY or relevant Fire Door manufacturer.

### Warning:

The Mkl Latching Adaptor (now part number 3770M1-ADAPTOR) can only be used with the Mkl Selector Mortise Locks and the Mkl Latching Adaptor (3770M2-ADAPTOR) can only be used with MklII Selector Mortise Locks.

### Legend

**Hub Setting**



**Lock Function Setting**



**Cam or Adaptor**



# Selector® 3770 Series Accessories

## Dual Entry Kits

Part Number	Application
3777-KIT	For new 3777 dual entry applications

Dual Entry kit includes: Lower cylinder mounting plate, spindle cam and mounting screws.

Cylinders must be ordered separately.

The new MkII 3770 Series Lower Cylinder Mounting Kit (3777-KIT) can hold the 570E, 577 and 10,000 cylinders. Selector MkI 3770 Series Lower Cylinder Mounting Kits can be ordered and are part numbers 3770M1-KIT570E and 3770M1-KIT577

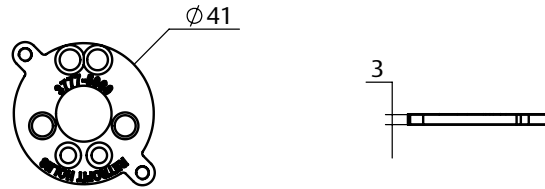

3777-KIT

## DX Digital Kits

Part Number	Application
3772-DXKITSC	DX Digital Kit
3772-DXKOKITSC	DX Digital with Key Override Kit

DX Digital kits include: Digital codepad, mounting plate, codepad spindle, associated mounting screws and a latching adaptor.

Cylinders and door furniture (1800 or 2800 series) must be ordered separately.

**Warning:**

The MkI Latching Adaptor (now part number 3770M1-ADAPTOR) can only be used with the MkI Selector Mortice Locks and the MkII Latching Adaptor (3770M2-ADAPTOR) can only be used with MkII Selector Mortice Locks.

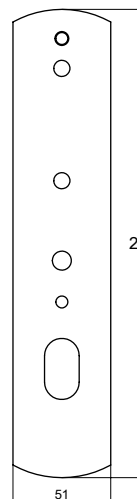
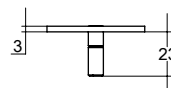
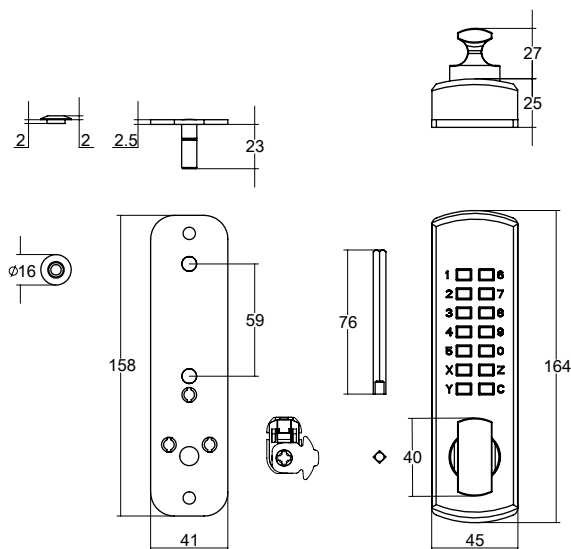

Mounting plate with lower cylinder hole, lower cylinder mounting plate and spindle cam are only included in 3772-DXKOKITSC

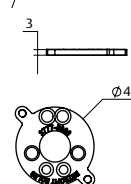

# Selector® 3770 Series Accessories

## Alternative Finish Kits

Part Number	Finish
3772-FINKITCP*	Chrome Plate
3772-FINKITPB	Polished Brass
3772-FINKITPC	Powder Coat

Finish kits include: Strike, faceplate and screws.  
 For 3774 Passage Latch, please specify 3774FINKITXX,  
 where XX designates finish.  
 \*Screws not included.

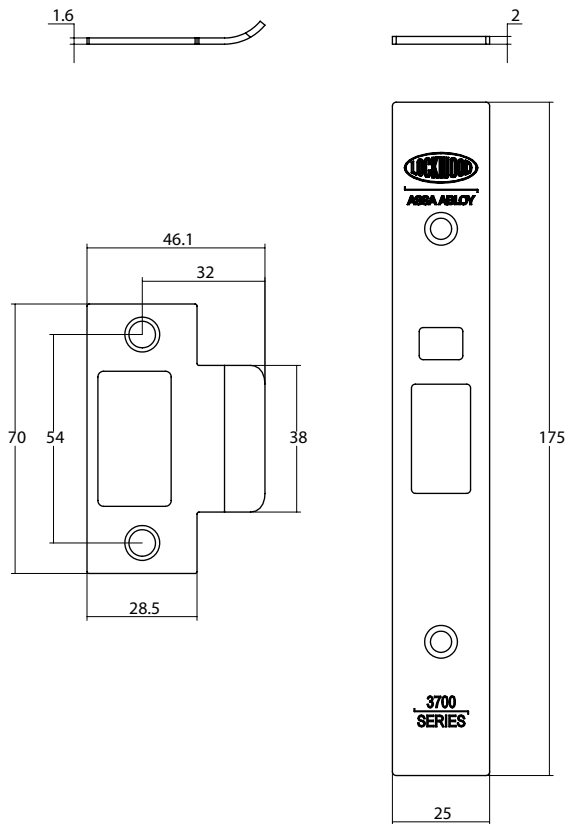

## Fire Rated (4hr) Rebate Kits

Part Number	Lip Length A
3772-RK32XX	32mm
3772-RK46XX	46mm

Rebate kits to suit standard 13mm rebate.  
 To order, add finish code to part number.  
 XX designates finish.  
**SS** - Stainless Steel, **CP** - Chrome Plate, **PB** - Polished Brass

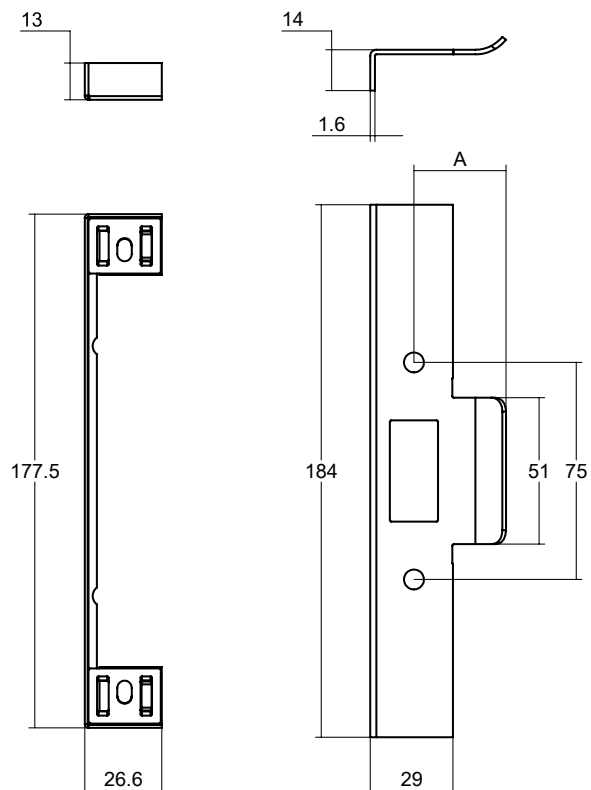

**Notes:**  
 For questions concerning our fire rated products, their specifications and their utilization please  
 contact ASSA ABLOY or relevant Fire Door Manufacturer.



# Selector<sup>®</sup> 3770 Series Accessories

## Aluminium Door Fixing Kit

Part Number	Finish
3772-AFKITSS*	Stainless Steel
3772-AFKITCP*	Chrome Plate
3772-AFKITPC	Powder Coat

For 3774 Passage Latch, please specify 3774-AFKITXX, where XX designates finish.

\*Faceplate screws not included

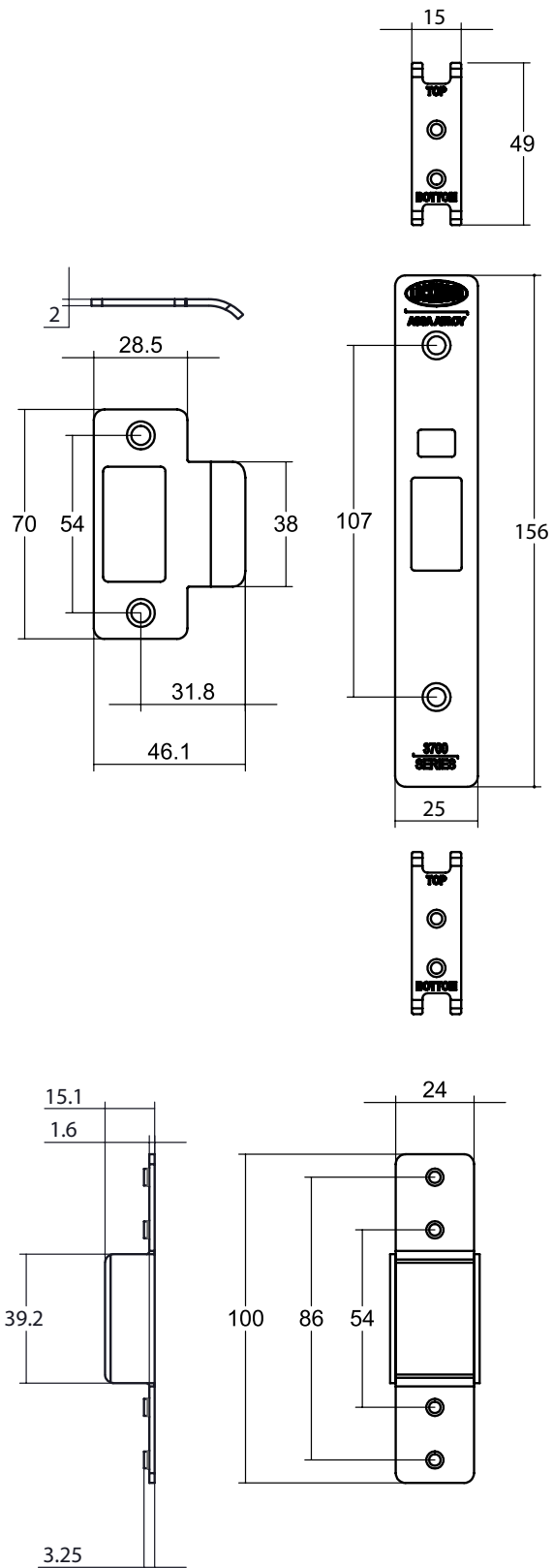

# Selector<sup>®</sup> 3770 Series Accessories

## Short/Extended Lipped Strikes

Part Number	Lip Length A	Lip Length B
3772-STK25XX	25.4mm	39.3mm
3772-STK32XX	32mm	46.1mm
3772-STK43XX	43.5mm	57.8mm
3772-STK47XX	47.5mm	61.8mm
3772-STK60XX*	60mm	74.2mm

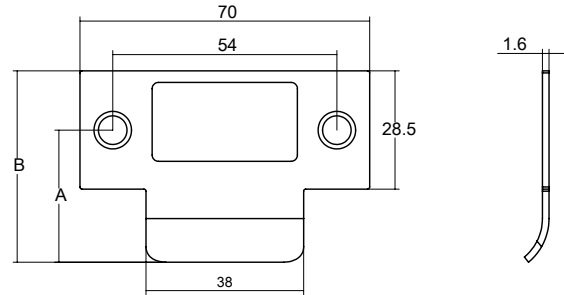

To order, add finish code to part number.

XX designates the finish.

**SS** - Stainless Steel, **CP** - Chrome Plate, **PB** - Polished Brass

\*Only available in Stainless Steel (**SS**) finish.

## ES2100 Electric Strike Faceplate

Part Number	Application
3772-2100SS	To suit 3770 Series
3772AF-2100SS*	To suit 3770 Series with Aluminium Door Fixing

To work in conjunction with the Lockwood Series ES2100 electric strike for door position monitoring.

\* Can be used directly with a 3772SS primary lock

- No additional AF fixing kit is required.

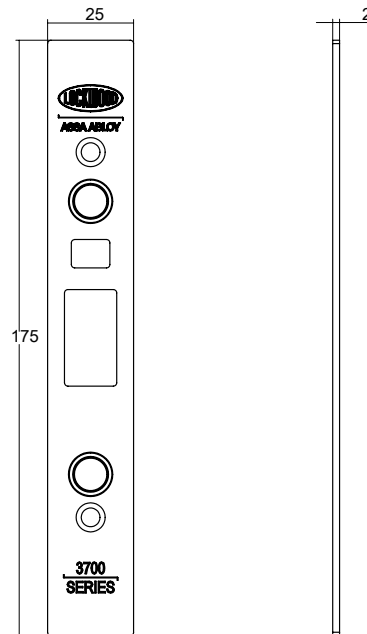

## Security Faceplate Screw Kit

Part Number	Application
3772-SECKIT	To suit 3770 Series

Kit contains two replacement faceplate screws with tamper resistant TR20 torx drive heads.

# Selector® 3770 Series Accessories

## Mortice Lock Spindles

Part Number	Pack Size	Length "A"	Door Thickness	
			Min	Max
SP3570-5018	10	33mm	32	50
SP3570-5228	1	45mm	50	75
SP3570-5238	1	58mm	75	100
SP3570-5258	1	108mm	100	200

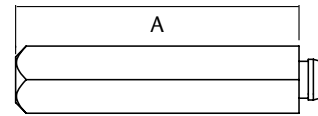
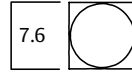

## Single Cylinder Assemblies

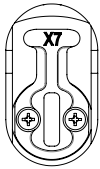

"X7" Cam Cylinder  
570C4/X7

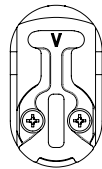

"V" Cam Cylinder  
570C4/V



3777 Lower Cylinder  
with Spindle Cam  
570EC4/77

## Cylinder Cams

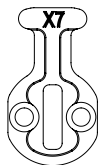

"X7" Cam  
SP3700/X7CAM

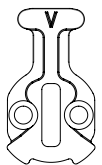

"V" Cam  
SP3700/VCAM

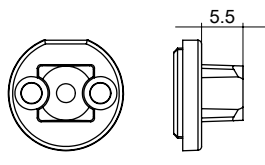

3777 Spindle Cam  
SP3777/CAM

## Adaptors

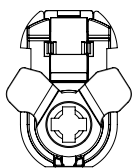

Locking Adaptor  
3772-ADAPTOR

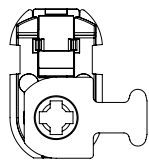

Latching Adaptor  
3770M1-ADAPTOR

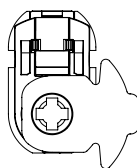

Latching Adaptor  
3770M2-ADAPTOR

### Warning:

The MkI Latching Adaptor (now part number 3770M1-ADAPTOR) can only be used with the MkI Selector Mortice Locks and the MkII Latching Adaptor (3770M2-ADAPTOR) can only be used with MkII Selector Mortice Locks.

# Selector® 3770 Series Cam and Adaptors Function Chart

## Selector® 3770 Series Cam and Adaptors Function Chart

Selector® 3770 Series	Function Description	Primary Lock	Outside Cylinder Cam/Adaptor	Inside Cylinder Cam/Adaptor	Kit
<b>Selector® 3770 Nightlatches</b>					
3770SS	Nightlatch Primary Lock	3770SS	-	-	
3770-TSS	Nightlatch with Turn	3770TSS	-	3770M2-ADAPTOR	
3770X-SS	Nightlatch with Cylinder	3770SS	X7	-	
3770XTSS	Nightlatch with Cylinder and Turn	3770TSS	X7	3770M2-ADAPTOR	
3770XXSS	Nightlatch with Double Cylinder	3770SS	X7	X7	
<b>Selector® 3772 Escape Locks</b>					
3772SS	Escape Primary Lock	3772SS	-	-	
3772-SS	Escape Lock	3772SS	-	-	
3772V-SS	Anti-vandal Escape Lock	3772SS	V	-	
3772VTSS	Anti-vandal Escape Lock with Turn	3772TSS	V	3772-ADAPTOR	
3772X-SS	Key Entry Escape Lock	3772SS	X7	-	
3772XTSS	Key Entry Escape Lock with Turn	3772TSS	X7	3772-ADAPTOR	
3772-VSS	Escape Lock with Internal Cylinder	3772SS	-	V	
3772-TSS	Escape Lock with Turn	3772TSS	-	3772-ADAPTOR	
3772VSS	Anti-vandal Escape Lock with Internal Cylinder	3772SS	V	V	
3772XVSS	Key Entry Escape Lock with Internal Cylinder	3772SS	X7	V	
3772-TASS	Anti-lockout Escape Lock with Turn	3772TSS	-	3772-ADAPTOR	
3772VTASS	Anti-lockout Anti-vandal Escape Lock with Turn	3772TSS	V	3772-ADAPTOR	
3772V-HSS	Holdback Anti-vandal Escape Lock	3772SS	V	-	
3772VTHSS	Holdback Anti-vandal Escape Lock with Turn	3772TSS	V	3772-ADAPTOR	
3772XVHSS	Holdback Key Entry Escape Lock with Internal Cylinder	3772SS	X7	V	
<b>Selector® 3774 Passage Latch</b>					
3774SS	Passage Latch	3774SS	-	-	
<b>Selector® 3774 Combination Locks</b>					
3774VTSS	Anti-vandal Lock with Turn	3772TSS	V	3772-ADAPTOR	
3774VSS	Anti-vandal Lock with Internal Cylinder	3772SS	V	V	
3774XVSS	Key Entry Lock with Internal Cylinder	3772SS	X7	V	
3774XXSS	Key Entry Double Cylinder Lock	3772SS	X7	X7	
3774-TSS	Combination Lock with Turn	3772TSS	-	3772-ADAPTOR	
3774-TASS	Anti-lockout Combination Lock with Turn	3772TSS	-	3772-ADAPTOR	
3774VTASS	Anti-lockout Anti-vandal Lock with Turn	3772TSS	V	3772-ADAPTOR	
3774VVAASS	Anti-lockout Anti-vandal Lock with Internal Cylinder	3772SS	V	V	
3774VTHSS	Holdback Anti-vandal Lock with Turn	3772TSS	V	3772-ADAPTOR	
3774VVHSS	Holdback Anti-vandal Lock with Internal Cylinder	3772SS	V	V	
3774XVHSS	Holdback Key Entry Lock with Internal Cylinder	3772SS	X7	V	
<b>Selector® 3777 Dual Entry Locks</b>					
3777X-SS	Dual Entry Lock	3772SS	X7, 3777 SPINDLE CAM	-	3777-KIT
3777V-SS	Dual Entry Lock with Lower Cylinder Lockout	3772SS	V, 3777 SPINDLE CAM	-	3777-KIT

# Selector® 3770 Series Cam and Adaptors Function Chart

## Selector® 3770 Series Cam and Adaptors Function Chart

Selector® 3770 Series	Function Description	Primary Lock	Outside Cylinder Cam/Adaptor	Inside Cylinder Cam/Adaptor	Kit
<b>Privacy Locks</b>					
3772-TSS	Escape Privacy Lock	3772TSS	-	3772-ADAPTOR	
3772-TASS	Anti-lockout Escape Privacy Lock	3772TSS	-	3772-ADAPTOR	
3774-TSS	Privacy Lock	3772TSS	-	3772-ADAPTOR	
3774-TASS	Anti-lockout Privacy Lock	3772TSS	-	3772-ADAPTOR	
3777-TSS	Key Entry Privacy Lock	3772TSS	3777 SPINDLE CAM	3772-ADAPTOR	3777-KIT
3777-TASS	Key Entry Anti-lockout Privacy Lock	3772TSS	3777 SPINDLE CAM	3772-ADAPTOR	3777-KIT
<b>Selector® 3772 DX Digital Locks</b>					
3772DX-SS	DX Digital Mortice Lock	3772SS	3770M2-ADAPTOR	-	3772-DXKITSC
3772DXVHSS	DX Digital Mortice Lock with Holdback by Cylinder	3772SS	3770M2-ADAPTOR	V	3772-DXKITSC
3772DXKO-SS	Key Override DX Digital Mortice Lock	3772SS	3770M2-ADAPTOR, 3777 SPINDLE CAM	-	3772-DXKOKITSC
3772DXKOVHSS	Key Override DX Digital Mortice Lock with Holdback by Cylinder	3772SS	3770M2-ADAPTOR, 3777 SPINDLE CAM	V	3772-DXKOKITSC

**Notes:** Items in Italics are Primary locks and can be purchased from ASSA ABLOY. Purchased configurations include adaptors as required. Cylinders must be ordered separately.

# Synergy Series Conversion Chart

## Synergy Series Conversion Chart

Synergy Series	Selector® 3770 Series	Function Description	Note
<b>Nightlatches</b>			
3570SC	3770SS	Nightlatch Primary Lock	
3570-T#SC	3770-TSS	Nightlatch with Turn	
3570X-#SC	3770X-SS	Nightlatch with Cylinder	
3570XT#SC	3770XTSS	Nightlatch with Cylinder and Turn	
3570XX#SC	3770XXSS	Nightlatch with Double Cylinder	
<b>Escape Locks</b>			
3572SC	3772SS	Escape Primary Lock	
3572EA#SC	3772-TASS	Anti-lockout Escape Privacy Lock	
3572M-#SC	3772V-SS	Anti-vandal Escape Lock	V cam has the functionality of locking lock and retracting bolt without an adaptor.
3572-T#SC	3772-TSS	Escape Lock with Turn	
3572WA#SC	3772VTASS	Anti-lockout Anti-vandal Escape Lock with Turn	V cam has the functionality of locking lock just as the W cam. V cam also retracts bolt after unlocking lock.
3572WT#SC	3772VTSS	Anti-vandal Escape Lock with Turn	V cam has the functionality of locking lock just as the W cam. V cam also retracts bolt after unlocking lock.
3572X-#SC	3772X-SS	Key Entry Escape Lock	X7 cam has the functionality of retracting bolt and locking lock. Does not have unlocking functionality.
3572XA#SC	3772VTASS	Anti-lockout Anti-vandal Escape Lock with Turn	V cam has the functionality of locking lock and retracting bolt without an adaptor.
3572XT#SC	3772XTSS	Key Entry Escape Lock with Turn	X7 cam has the functionality of retracting bolt and locking lock. Does not have unlocking functionality.
3572XZ#SC	3772XVSS	Key Entry Escape Lock with Internal Cylinder	V cam has the functionality of locking lock just as the Z cam. V cam also retracts bolt after unlocking lock. X7 cam has the functionality of retracting bolt and locking lock. Does not have unlocking functionality.
3572-Z#SC	3772-VSS	Escape Lock with Internal Cylinder	V cam has the functionality of locking lock just as the Z cam. V cam also retracts bolt after unlocking lock.
3572Z-#SC	3772V-SS	Anti-vandal Escape Lock	V cam has the functionality of locking lock just as the Z cam. V cam also retracts bolt after unlocking lock.
<b>Combination Locks</b>			
3574SC	3774SS	Passage Latch	
3574ET#SC	3774-TSS	Privacy Lock	
3574WT#SC	3774VTSS	Anti-vandal Lock with Turn	V cam has the functionality of locking lock just as the W cam. V cam also retracts bolt after unlocking lock.
3574XX#SC	3774XXSS	Key Entry Double Cylinder Lock	X7 cam has the functionality of retracting bolt and locking lock. Does not have unlocking functionality.
3574XZ#SC	3774XVSS	Key Entry Lock with Internal Cylinder	V cam has the functionality of locking lock just as the Z cam. V cam also retracts bolt after unlocking lock. X7 cam has the functionality of retracting bolt and locking lock. Does not have unlocking functionality.
3574-Z#SC	3774-VSS	Combination Lock with Internal Cylinder	V cam has the functionality of locking lock just as the Z cam. V cam also retracts bolt after unlocking lock.
3574Z-#SC	3774V-SS	Anti-vandal Combination Lock	V cam has the functionality of locking lock just as the Z cam. V cam also retracts bolt after unlocking lock.
3574ZZ#SC	3774VSS	Anti-vandal Lock with Internal Cylinder	V cam has the functionality of locking lock just as the Z cam. V cam also retracts bolt after unlocking lock.
<b>Dual Entry Locks</b>			
3577SC			3772SS primary lock can be converted to a dual entry lock with the 3777M1-KIT570E kit.
3577EA#SC	3777-TASS	Key Entry Anti-lockout Privacy Lock	
3577M-#SC	3777V-SS	Dual Entry Lock with Lower Cylinder Lockout	V cam has the functionality of locking lock and retracting bolt without an adaptor.
3577X-#SC	3777X-SS	Dual Entry Lock	X7 cam has the functionality of retracting bolt and locking lock. Does not have unlocking functionality.
<b>Holdback Locks</b>			
3578SC			Holdback functionality is available in 3772 primary lock.
3578M-#SC	3772V-HSS	Holdback Anti-vandal Escape Lock	V cam has the functionality of locking lock and retracting bolt without an adaptor.
3578WT#SC	3772VTHSS	Holdback Anti-vandal Escape Lock with Turn	V cam has the functionality of locking lock just as the W cam. V cam also retracts bolt after unlocking lock.
3578Z-#SC	3772V-HSS	Holdback Anti-vandal Escape Lock	V cam has the functionality of locking lock just as the Z cam. V cam also retracts bolt after unlocking lock.
3578XZ#SC	3772XVHSS	Holdback Key Entry Escape Lock with Internal Cylinder	V cam has the functionality of locking lock just as the Z cam. V cam also retracts bolt after unlocking lock. X7 cam has the functionality of retracting bolt and locking lock. Does not have unlocking functionality.

# Synergy Series Conversion Chart

## Synergy Series Conversion Chart

Synergy Series	Selector® 3770 Series	Function Description	Note
<b>Extended Lip Strikes</b>			
SP3570-4053SSS	3772-STK25SS	3772 SHORT LIP STRIKE 25.4MM LIP	
SP3570-4153CP	3772-STK25CP	3772 SHORT LIP STRIKE 25.4MM LIP	
SP3570-4153PB	3772-STK25PB	3772 SHORT LIP STRIKE 25.4MM LIP	
SP3570-5053SSS	3772-STK32SS	3772 STANDARD STRIKE 32MM LIP PK=10	
SP3570-5153CP	3772-STK32CP	3772 STANDARD STRIKE 32MM LIP PK=10	
SP3570-5153PB	3772-STK32PB	3772 STANDARD STRIKE 32MM LIP PK=10	
SP3570-5253SSS	3772-STK43SS	3772 LONG LIP STRIKE 43.5MM LIP	
SP3570-5353CP	3772-STK43CP	3772 LONG LIP STRIKE 43.5MM LIP	
SP3570-5353PB	3772-STK43PB	3772 LONG LIP STRIKE 43.5MM LIP	
SP3570-5453SSS	3772-STK47SS	3772 LONG LIP STRIKE 47MM LIP	
SP3570-5653CP	3772-STK47CP	3772 LONG LIP STRIKE 47MM LIP	
SP3570-5653PB	3772-STK47PB	3772 LONG LIP STRIKE 47MM LIP	
SP3570-5960SS	3772-STK60SS	3772 LONG LIP STRIKE 60MM LIP	
SP500-252ZP	3772-STKBOX	3772 STRIKE BOX PK=10	
<b>Rebate Kits</b>			
3P72-RK32SS	3772-RK32SS	3772 SERIES REBATE KIT- 32MM LIP STRIKE	
3P72-RK32CP	3772-RK32CP	3772 SERIES REBATE KIT- 32MM LIP STRIKE	
3P72-RK32PB	3772-RK32PB	3772 SERIES REBATE KIT- 32MM LIP STRIKE	
3P72-RK46SS	3772-RK46SS	3772 SERIES REBATE KIT- 46MM LIP STRIKE	
3P72-RK46CP	3772-RK46CP	3772 SERIES REBATE KIT- 46MM LIP STRIKE	
3P72-RK46PB	3772-RK46PB	3772 SERIES REBATE KIT- 46MM LIP STRIKE	

# Selector® 3770 Series Cylinder Mortice Locks Functioning Matrix

## Functioning Matrix

Sample part number 3772VTASS is made up of seven elements.

The description of this part number is an Anti-lockout Anti-vandal escape lock with cylinder and turn in satin stainless steel finish. Choose your product by selecting an option from each element.

Backset	Series	Platform	Function	Sub Function	Lock Function Setting	Finish
3	7	7	2	VT	A	SS

Backset	Sub Function	Lock Function Setting
60mm 3	e.g. Outside Inside V T	Neutral
89mm 4	Locking and Latching Cylinder with V Cam V	Anti-lockout A
127mm 5	Latching Cylinder with X7 Cam X	Holdback H

Series	Sub Function	Finish
Selector® Series Mortice Locks 7	Turnbutton Adaptor T	Stainless Steel SS
	No Sub Function -	

Platform	Sub Function
Standard Backset 7	DX Digital DX
	DX Digital with Key Override DXKO

Functions	Sub Function
Nightlatch 0	
Escape Lock 2	
Combination Lock 4	
Dual Entry Lock 7	

## Code

**1. Backset:** Nominate backset as required, for example 3 = 60mm backset.

**2. Function:** Select function, for example 772 = Escape Lock

**3. Sub Function:** Determine sub function requirements for both exterior and interior.

For example:

Exterior – Locking function required – specify V (cylinder).

Interior – Turnknob function required – specify T

(turnbutton adaptor).

**4. Locking Function Setting:** Determine lock function requirements.

For example:

Anti-lockout - Specify A

**5. Finish:** Select appropriate finish, e.g. SS

Other finishes available by specifying finish kits.





# Selector® 3780 MKI Series Mortice Locks

# Selector® 3780 Series Cylinder Mortice Locks

A comprehensive range of cylinder mortice locks for narrow stile hinged doors, suitable for heavy duty use in industrial and commercial buildings, shop fronts, clubs, schools, hospitals, hotels and similar buildings.

## Benefits

- Easy red/green function setting
- All lock settings are made from under the faceplate allowing for simple in-door configuration
- Standard primary locks include anti-lockout and holdback capabilities
- Improved cylinder functions including lock/unlock and retract latch as standard
- Reduced range of cylinder cams and turn adaptors relative to other commonly available commercial cylinder mortice locks

## Features and Specifications

The Australian designed and made Selector® 3780 Series Short Backset Cylinder Mortice Locks are made from quality materials to meet high durability and strength requirements.

## Case and Faceplates

- High purity zinc alloy material cases with stainless steel chassis plates. Stainless steel faceplates provided as standard.
- Brass faceplates are available for alternative finishes

## Backset

23mm standard backset. Extended backsets 25.4mm, 30mm and 38mm are available, refer to function matrix (Page 76)

## Latch Bolts

- Latch bolts are made with stainless steel, 15mm in size
- Deadlatching is achieved by an auxiliary stainless steel latch bolt
- Reversible for both left and right hand doors, opening in or opening out whilst lock is in door
- Electric strike compatibility
- Separate auxiliary bolt moves into lock case simultaneously with latch bolt
- Radius bolt provides greater deadlatch throw and smoother closing action

## Cylinder Retaining Pin

- Hard-drawn spring steel wire, corrosion protected

## Door Thickness

- Metal doors: 35 to 50mm
- Suits hollow-style aluminium door sections with 38mm minimum internal depth
- Timber doors: 32 to 50mm
- Specify 3782-TFKIT for timber door fixing kit to convert an aluminium fix lock suit timber door fixing. The timber door fixing kit includes a long faceplate, strike and screws to suit a timber door and jamb

## Cylinder

Requires standard Lockwood oval shaped brass cylinders and brass barrels. Lockwood cylinders include bump resistant five pin tumbler mechanism.

Functions require the use of different cams and adaptors.

## Keying

### Restricted Special Keying

Lockwood locks can be keyed to a number of controlled and/or specially keyed systems. These range from legally protected keys to protect against unauthorised duplication and can also include specially designed keying systems such as master key systems. This allows for different levels of mechanical access control.

Please refer to [assaabloy.com.au](http://assaabloy.com.au) for keying systems or contact your local sales office or customer service for specific information.

## Security

All Selector® 3780 Series Cylinder Mortice Locks conform with Level S7 (Physical Security) Australian Lock Standard (AS-4145.2-2008). Conforms to Level S8 (Physical Security) when fitted with door furniture and anti-drill cylinder.

## Durability

All Selector® 3780 Series Cylinder Mortice Locks conform with Level D8 (Durability) Australian Lock Standard (AS 4145.2-2008).

## Anti-Corrosion

All Selector® 3780 Series Cylinder Mortice Locks conform with Level C6 (168 hours) Australian Lock Standard (AS4145.2-2008).

## Door Clearance

To ensure correct functioning of the deadlatching mechanism and security for all locks, the clearance between the door and frame should be no less than 3mm. The deadlatching will operate up to 8mm door clearance, however door clearances over 5mm are not recommended.

## Standard Finishes

Stainless Steel SS

## Extended Cylinders

Modular cylinder extensions are available for thicker doors.

## Rebate

Rebate kits to suit 13mm standard rebate are available. Only suitable for use with 30mm and 38mm backset locks.

## Electric Strikes

Lockwood offers a wide range of electric strikes which are compatible with the Selector® 3780 Series Mortice Lock.

For further details refer to [lockweb.com.au](http://lockweb.com.au)

**S7 HIGH SECURITY**

**D8 DURABILITY**

**ANTI-CORROSION**

# Selector® 3780 Series Cylinder Mortice Locks

## 1. Multi-function Lock

The new Selector® 3780 Series Mortice Lock was designed to incorporate the full range of lock functions into one primary lock. This reduces stock line items. All functions can be configured by adjusting the hub setting selector, anti-lockout selector as well as using cylinder cams and turn adaptors.

## 2. Hub Setting Selection

Hub settings can be adjusted via the Selector® 3780 series hub selector located under the faceplate of the mortice lock. The hub setting allows for three functions: Passage, Combination, or Escape function. This is done by rotating the dial with a 4mm flat blade screwdriver.

RED - Handle is lockable. Only opened by handle when locking bar is unlocked (up).

GREEN - Opened by handle at all times.

## 3. Anti-lockout Selection

Anti-lockout function can now be selected via a switch under the faceplate of the mortice lock. This is done by depressing on the anti-lockout indicated part of the switch with a 4mm flat blade screwdriver. Clearance between door and frame should not be over 5mm to ensure anti-lockout mechanism functions correctly.

## 4. Case Assembly

Zinc diecast body with stainless steel chassis plates for improved strength.

## 5. Backsets

- Standard Backset - 23mm

Extended backsets 25.4, 30 and 38mm are available (Refer to Ordering Procedure on page 79)

## 6. Cylinder/Adaptor Retention

"Slip Pin" Cylinder/Adaptor fixing method, which allows attachment to the lock case by inserting a non-threaded cylindrical pin through the front of the lock case.

## 7. Cylinder Assembly

Five pin tumbler mechanism. Standard Lockwood oval shaped, brass cylinders and brass barrels. Only two newly designed cams needed for all lock functions.

X7 Cam - Retracts latch bolt with additional ability of locking the locking bar.

V Cam - Locks and unlocks the locking bar. Also retracts latch bolt after unlocking lock.

## 8. Synergy Retrofit

The Selector® 3780 Series Mortice Lock is designed to have an equivalent case size as the Synergy Series Mortice Lock to ensure retrofitability.

## 9. Lock Fixing and Kits

The Selector® 3780 Series primary lock is designed for aluminium doors. Various kit conversions are available for timber door applications, alternative finishes as well as dual entry and DX digital locksets.

## Holdback Function

Lock is always holdback capable, no setting is required. Holdback can be activated at any time - unless anti-lockout is selected.

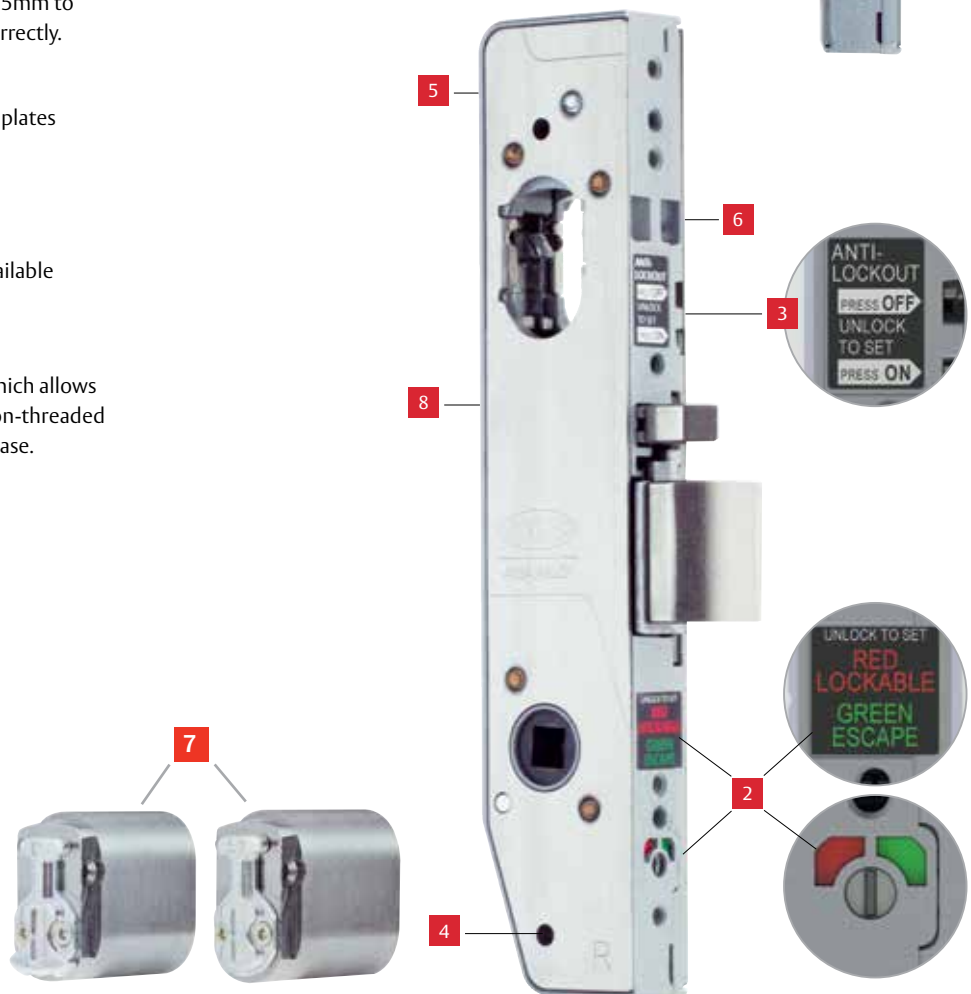

# Selector® 3782 Short Backset Escape Locks



## Description

These locks have various latching functions operated generally by key or handle outside and by turnknob, key or handle inside. These locks comply with building regulations for single-action escape doors.

## Product Details

<b>Furniture</b>	Compatible with Lockwood 4800 and 5800 Series Furniture. Refer to <a href="http://lockweb.com.au">lockweb.com.au</a> for further details.
<b>Latch</b>	Deadlatch only.
<b>Standard Finishes</b>	Stainless Steel (SS) Other finishes available via finish kit conversions.

# Selector® 3782 Short Backset Escape Locks

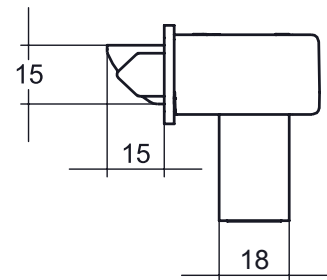
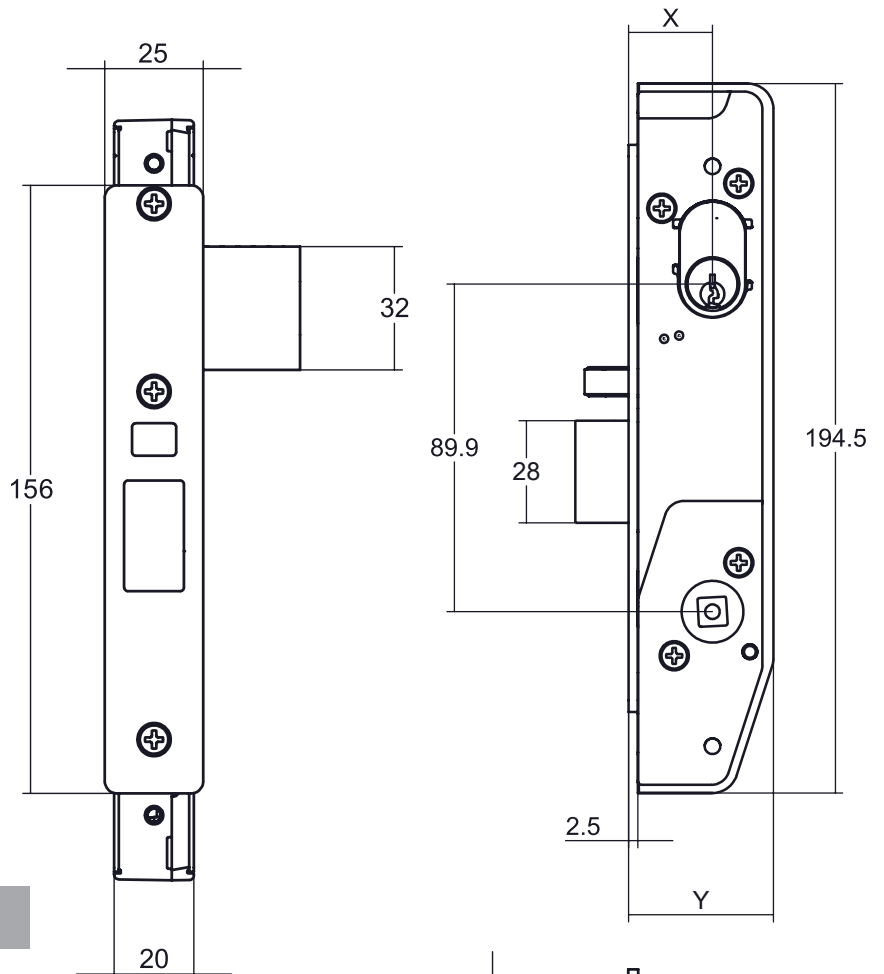

## Selector® 3782 Short Backset Escape Locks

Part Number	3782	4782	5782	6782
Dimension X	23	25.4	30	38
Dimension Y	40	42.4	47	55
Minimum internal depth of door	40	43	47	55

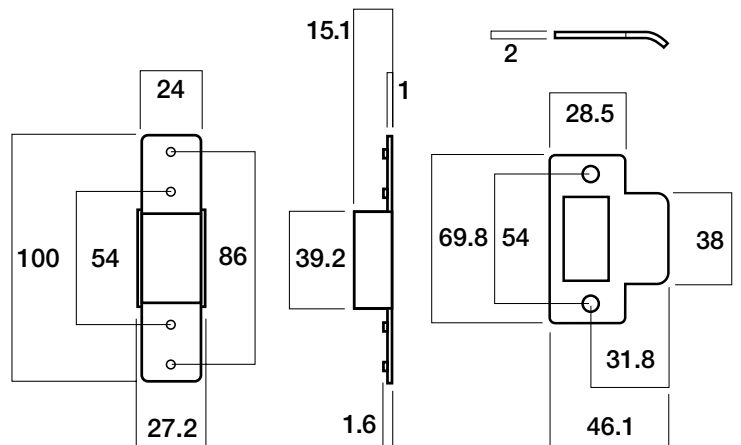

# Selector® 3782 Short Backset Escape Locks

## Escape Lock

**Part Number** 3782--

**Outside:** Handle always rigid.

**Inside:** Opened by handle at all times

This function requires the locking bar to be positioned in the locked position once lock is set.

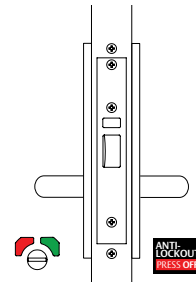

## Anti-vandal Escape Lock<sup>#</sup>

**Part Number** 3782V-

Single cylinder.

**Outside:** Opened by handle when unlocked. Key locks or unlocks outside handle and retracts bolt after unlocking lock.

**Inside:** Opened by handle at all times.

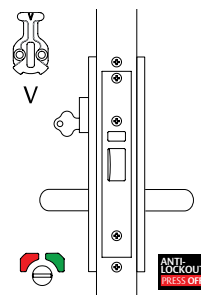

## Anti-vandal Escape Lock with Turn<sup>#</sup>

**Part Number** 3782VT

Cylinder and turnknob.

**Outside:** Opened by handle when unlocked. Key locks or unlocks outside handle and retracts bolt after unlocking lock.

**Inside:** Opened by handle at all times. Turnknob locks or unlocks outside handle.

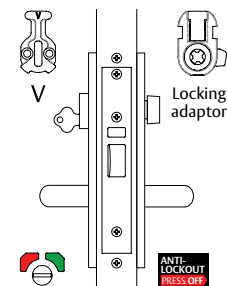

## Key Entry Escape Lock

**Part Number** 3782X-

Single cylinder.

**Outside:** Opened by key at all times. Handle always rigid.

**Inside:** Opened by handle at all times.

This function requires the locking bar to be positioned in the locked position once lock is set.

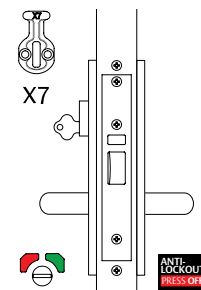

### Notes:

All drawings shown are in right hand configuration. Part numbers shown above are for 23mm backset lock, if 25.4mm is required substitute 3 for 4 i.e. 4782, or if 30mm or 38mm lock is required, substitute 5 for 5 or 6 respectively i.e. 5782, 6782

\*Anti-lockout - Closing the door or retracting latch bolt unlocks the lock, preventing lockout situations.

#Latch bolt can be held within the lock. Lock function recommended for use in holdback application.

### Legend

Hub Setting



Anti-lockout Selection



Cam or Adaptor



# Selector® 3782 Short Backset Escape Locks

## Key Entry Escape Lock with Turn#

**Part Number** 3782XT

Cylinder and turnknob.

**Outside:** Opened by key at all times. Opened by handle when unlocked. Key locks outside handle.

**Inside:** Opened by handle at all times. Turnknob locks or unlocks outside handle.

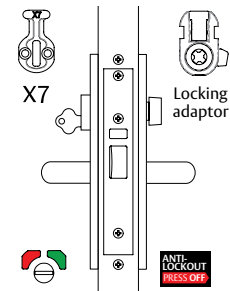

## Escape Lock with Internal Cylinder#

**Part Number** 3782-V

Cylinder inside.

**Outside:** Opened by handle when unlocked.

**Inside:** Opened by handle at all times. Cylinder locks or unlocks outside handle and retracts bolt after unlocking lock.

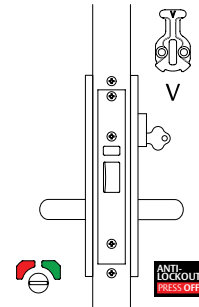

## Escape Lock with Turn#

**Part Number** 3782-T

Turnknob inside.

**Outside:** Opened by handle when unlocked.

**Inside:** Opened by handle at all times. Turnknob locks or unlocks outside handle.

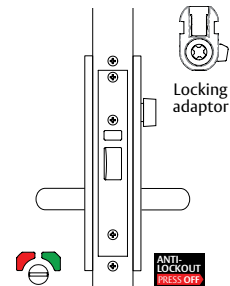

## Key Entry Escape Lock with Internal Cylinder#

**Part Number** 3782XV

Double Cylinder.

**Outside:** Opened by key at all times. Opened by handle when unlocked. Key locks outside handle.

**Inside:** Opened by handle at all times. Key locks or unlocks outside handle and retracts bolt after unlocking lock.

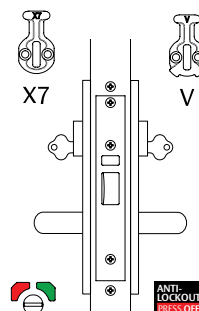

### Notes:

All drawings shown are in right hand configuration. Part numbers shown above are for 23mm backset lock, if 25.4mm is required substitute 3 for 4 i.e. 4782, or if 30mm or 38mm lock is required, substitute 3 for 5 or 6 respectively i.e. 5782, 6782

\*Anti-lockout - Closing the door or retracting latch bolt unlocks the lock, preventing lockout situations.

#Latch bolt can be held within the lock. Lock function recommended for use in holdback application.

### Legend

**Hub Setting**



**Anti-lockout Selection**



**Cam or Adaptor**



X7

# Selector® 3782 Short Backset Escape Locks

## Anti-lockout Escape Lock with Turn\*

**Part Number** 3782-TA

Turnknob inside.

**Outside:** Opened by handle when unlocked.

**Inside:** Opened by handle at all times. Turnknob locks or unlocks outside handle.

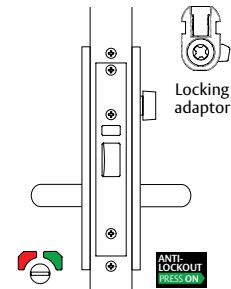

## Anti-lockout Anti-vandal Escape Lock with Turn\*

**Part Number** 3782VTA

Cylinder and turnknob.

**Outside:** Opened by handle when unlocked. Key locks or unlocks outside handle and retracts bolt after unlocking lock.

**Inside:** Opened by handle at all times. Turnknob locks or unlocks outside handle.

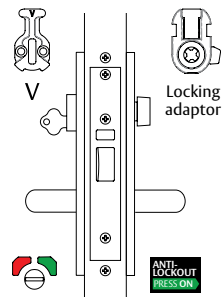

### Notes:

All drawings shown are in right hand configuration. Part numbers shown above are for 23mm backset lock, if 25.4mm is required substitute 3 for 4 i.e. 4782, or if 30mm or 38mm lock is required, substitute 3 for 5 or 6 respectively i.e. 5782, 6782

\*Anti-lockout - Closing the door or retracting latch bolt unlocks the lock, preventing lockout situations.

#Latch bolt can be held within the lock. Lock function recommended for use in holdback application.

### Legend

**Hub Setting**



**Anti-lockout Selection**



**Cam or Adaptor**





# Selector® 3784 Short Backset Combination Locks



## Description

These locks have various latching functions operated generally by outside or inside handles, except when locked by key outside or by key or turnknob inside.

## Product Details

<b>Furniture</b>	Compatible with Lockwood 4800 and 5800 Series Furniture. Refer to <a href="http://lockweb.com.au">lockweb.com.au</a> for further details.
<b>Latch</b>	Deadlatch only.
<b>Standard Finishes</b>	Stainless Steel (SS) Other finishes available via finish kit conversions.

# Selector® 3784 Short Backset Combination Locks

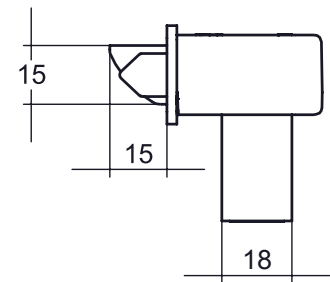
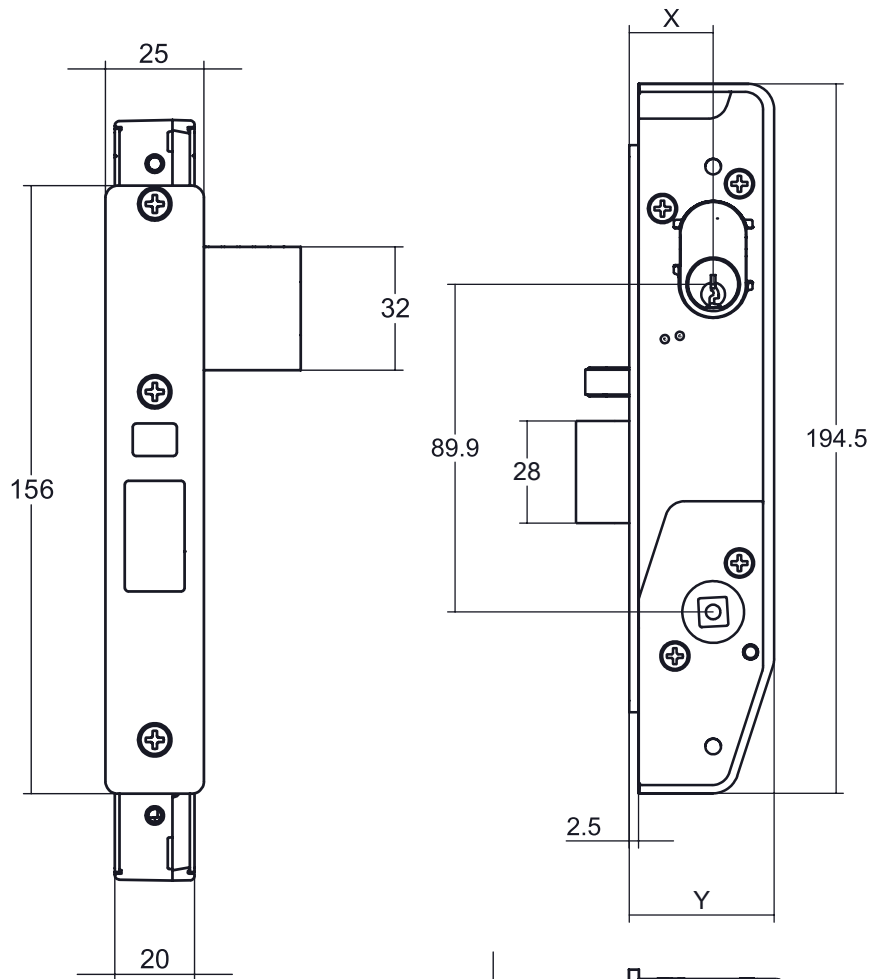

## Selector® 3784 Short Backset Combination Locks

Part Number	3784	4784	5784	6784
Dimension X	23	25.4	30	38
Dimension Y	40	42.4	47	55
Minimum internal depth of door	40	43	47	55

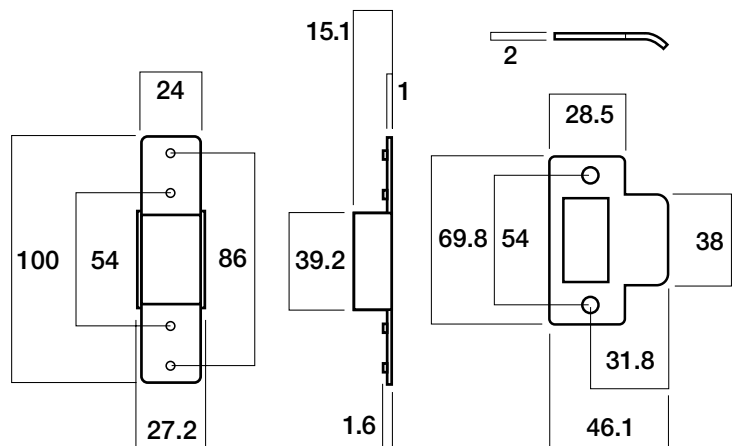

# Selector® 3784 Short Backset Combination Locks

Passage Latch	
Part Number	3784

No locking function. Plainlatch only.  
**Outside:** Opened by handle at all times.  
**Inside:** Opened by handle at all times.

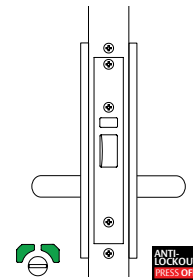

Anti-vandal Lock with Turn#	
Part Number	3784VT

Cylinder and turnknob.  
**Outside:** Opened by handle when unlocked. Key locks or unlocks both handles and retracts bolt after unlocking lock.  
**Inside:** Opened by handle when unlocked. Turnknob locks or unlocks both handles.

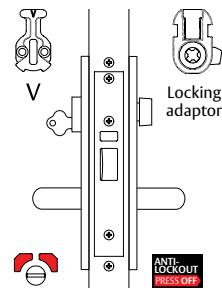

Anti-vandal Lock with Internal Cylinder#	
Part Number	3784VV

Double cylinder.  
**Outside:** Opened by handle when unlocked. Key locks or unlocks both handles and retracts bolt after unlocking lock.  
**Inside:** Opened by handle when unlocked. Key locks or unlocks both handles and retracts bolt after unlocking lock.

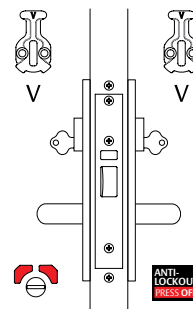

Key Entry Lock with Internal Cylinder#	
Part Number	3784XV

Double cylinder.  
**Outside:** Opened by key at all times. Opened by handle when unlocked. Key locks both handles.  
**Inside:** Opened by handle when unlocked. Key locks or unlocks both handles and retracts bolt after unlocking lock.

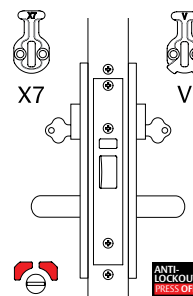

**Notes:**  
 All drawings shown are in right hand configuration. Part numbers shown above are for 23mm backset lock, if 25.4mm is required substitute 3 for 4 i.e. 4784, or if 30mm or 38mm lock is required, substitute 3 for 5 or 6 respectively i.e. 5784, 6784  
 \*Anti-lockout - Closing the door or retracting latch bolt unlocks the lock, preventing lockout situations.  
 #Latch bolt can be held within the lock. Lock function recommended for use in holdback application.

Legend	
Hub Setting	
Anti-lockout Selection	
Cam or Adaptor	 X7

# Selector® 3784 Short Backset Combination Locks

## Key Entry Double Cylinder Lock

**Part Number** 3784XX

Double cylinder.

**Outside:** Opened by key at all times. Handle always rigid.

**Inside:** Opened by key at all times. Handle always rigid.

This function requires the locking bar to be positioned in the locked position once lock is set.

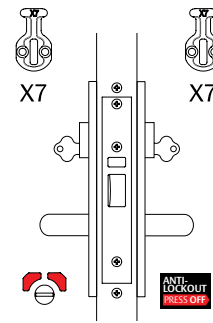

## Combination Lock with Turn<sup>#</sup>

**Part Number** 3784-T

Turnknob inside.

**Outside:** Opened by handle when unlocked.

**Inside:** Opened by handle when unlocked. Turnknob locks or unlocks both handles.

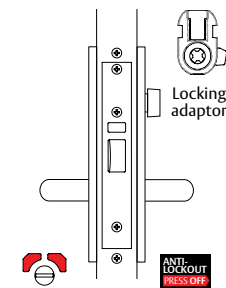

## Anti-lockout Combination Lock with Turn<sup>\*</sup>

**Part Number** 3784-TA

Turnknob inside.

**Outside:** Opened by handle when unlocked.

**Inside:** Opened by handle when unlocked. Turnknob locks or unlocks both handles.

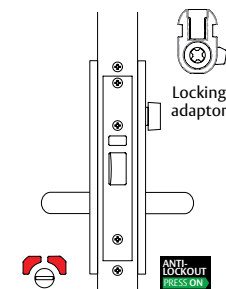

## Anti-lockout Anti-vandal Lock with Turn<sup>\*</sup>

**Part Number** 3784VTA

Cylinder and turnknob.

**Outside:** Opened by handle when unlocked. Key locks or unlocks both handles and retracts bolt after unlocking lock.

**Inside:** Opened by handle when unlocked. Turnknob locks or unlocks both handles.

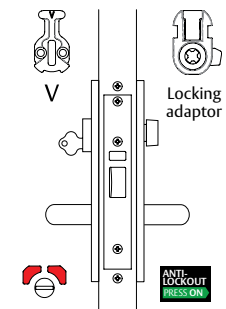

### Notes:

All drawings shown are in right hand configuration. Part numbers shown above are for 23mm backset lock, if 25.4mm is required substitute 3 for 4 i.e. 4784, or if 30mm or 38mm lock is required, substitute 3 for 5 or 6 respectively i.e. 5784, 6784

\*Anti-lockout - Closing the door or retracting latch bolt unlocks the lock, preventing lockout situations.

#Latch bolt can be held within the lock. Lock function recommended for use in holdback application.

Legend	
Hub Setting	
Anti-lockout Selection	
Cam or Adaptor	

# Selector® 3784 Short Backset Combination Locks

Anti-lockout Anti-vandal Lock with Internal Cylinder\*

**Part Number** 3784VVA

Double cylinder.

**Outside:** Opened by handle when unlocked. Key locks or unlocks both handles and retracts bolt after unlocking lock.

**Inside:** Opened by handle when unlocked. Key locks or unlocks both handles and retracts bolt after unlocking lock.

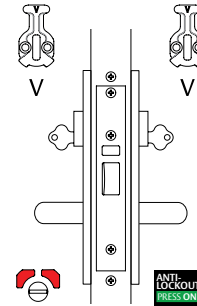

**Notes:**

All drawings shown are in right hand configuration. Part numbers shown above are for 23mm backset lock, if 25.4mm is required substitute 3 for 4 i.e. 4784, or if 30mm or 38mm lock is required, substitute 3 for 5 or 6 respectively i.e. 5784, 6784

\*Anti-lockout - Closing the door or retracting latch bolt unlocks the lock, preventing lockout situations.

#Latch bolt can be held within the lock. Lock function recommended for use in holdback application.

Legend	
Hub Setting	
Anti-lockout Selection	
Cam or Adaptor	



# Selector® 3787 Short Backset Dual Entry Locks



## Description

Designed to enable third parties such as emergency services to enter specific areas by second cylinder without giving access to all locksets in the building and the ability to lockout keys with restricted access at certain times.

## Product Details

<b>Furniture</b>	Compatible with Lockwood 4800 and 5800 Series Furniture. Refer to <a href="http://lockweb.com.au">lockweb.com.au</a> for further details.
<b>Latch</b>	Deadlatch only.
<b>Standard Finishes</b>	Stainless Steel (SS) Other finishes available via finish kit conversions.

# Selector® 3787 Short Backset Dual Entry Locks

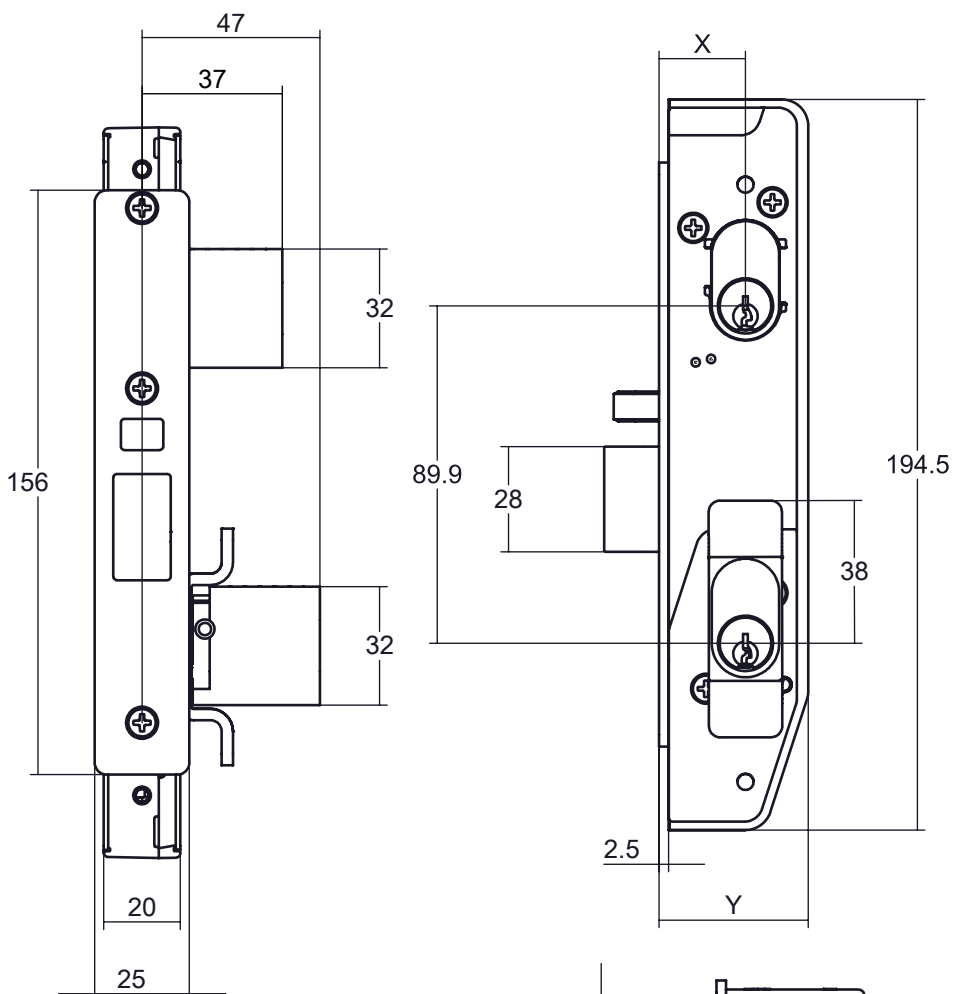

## Selector® 3787 Short Backset Dual Entry Locks

Part Number 3787 4787 5787 6787

Dimension X 23 25.4 30 38

Dimension Y 40 42.4 47 55

Minimum internal depth of door 40 43 47 55

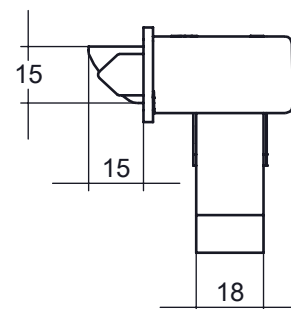

\*Order by specifying 3782SS primary lock and 3787-KIT570E Dual Entry Kit. Cylinders must be ordered separately. Dual Entry Kit only suits 43 - 46mm door thickness.

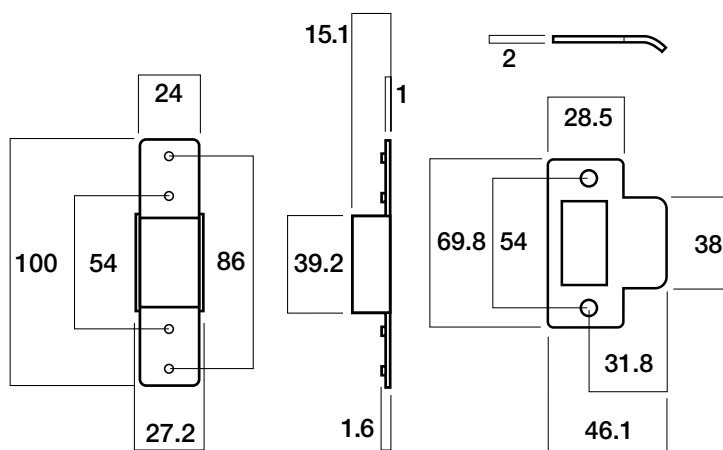

# Selector® 3787 Short Backset Dual Entry Locks

## Dual Entry Lock

**Part Number** 3787X-

Two cylinders outside.

**Outside:** Opened by key. Cylinders are keyed to differ.

**Inside:** Opened by handle at all times.

This function requires the locking bar to be positioned in the locked position once lock is set.

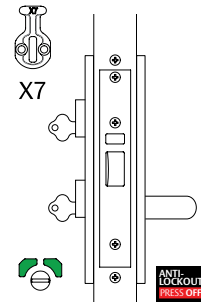

## Dual Entry Lock with Lower Cylinder Lockout

**Part Number** 3787V-

Two cylinders outside.

**Outside:** Opened by key when unlocked. Upper cylinder key locks or unlocks lower cylinder and retracts bolt after unlocking lock. Cylinders are keyed to differ.

**Inside:** Opened by handle at all times.

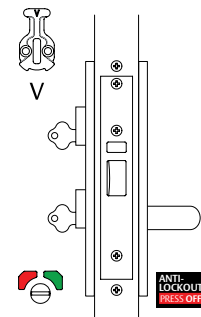

### Notes:

All drawings shown are in right hand configuration. Part numbers shown above are for 23mm backset lock, if 25.4mm is required substitute 3 for 4 i.e. 4787, or if 30mm or 38mm lock is required, substitute 3 for 5 or 6 respectively i.e. 5787, 6787

### Legend

**Hub Setting**



**Anti-lockout Selection**



**Cam or Adaptor**





# Selector® 3782 Short Backset DX Digital Mortice Locks



## Description

Lockwood DX Digital Locksets provide a mechanical method of keyless entry.

For extra security when under forced attack, the inbuilt clutching mechanism allows the outside turnknob to rotate without operating or damaging the lock.

The factory set 4 digit code is easily changed to any 4, 5 or 6 digit code using the code changing kit provided with each lock.

Lockwood Digital DX Locksets are designed to control access in commercial areas.

As the digital lockset utilizes mechanical operation, electrical wiring is not required.

## Product Details

<b>Door Thickness</b>	32 to 50mm for timber doors. 35 to 50mm for metal doors
<b>Finish</b>	Codepad: Satin Chrome Brushed (SC) Mortice Lock: Stainless Steel (SS)
<b>Codepad Assembly</b>	High purity zinc alloy, 45mm wide, 164mm high, 52mm projection
<b>Latch</b>	Stainless steel with 15mm projection

Note: As suitability of lever will be influenced by the lock backset, refer to chart for Lever/Backset compatibility Lockwood Door Handle Catalogue. Lockwood 4800 and 5800 Series (ordered separately).

### Backset

Open-out door: 23, 25.4, 30 and 38mm.  
Open-in door: 38mm recommended.  
Installation of 23, 25.4 or 30mm on open-in doors would require the door stop to be machined to clear the digital pad.

### Inside Function

Opened by lever handle at all times.

### Holdback Function

Holdback function is available, this requires the inclusion of an internal cylinder.

# Selector® 3782 Short Backset DX Digital Mortise Locks



Exterior



Interior

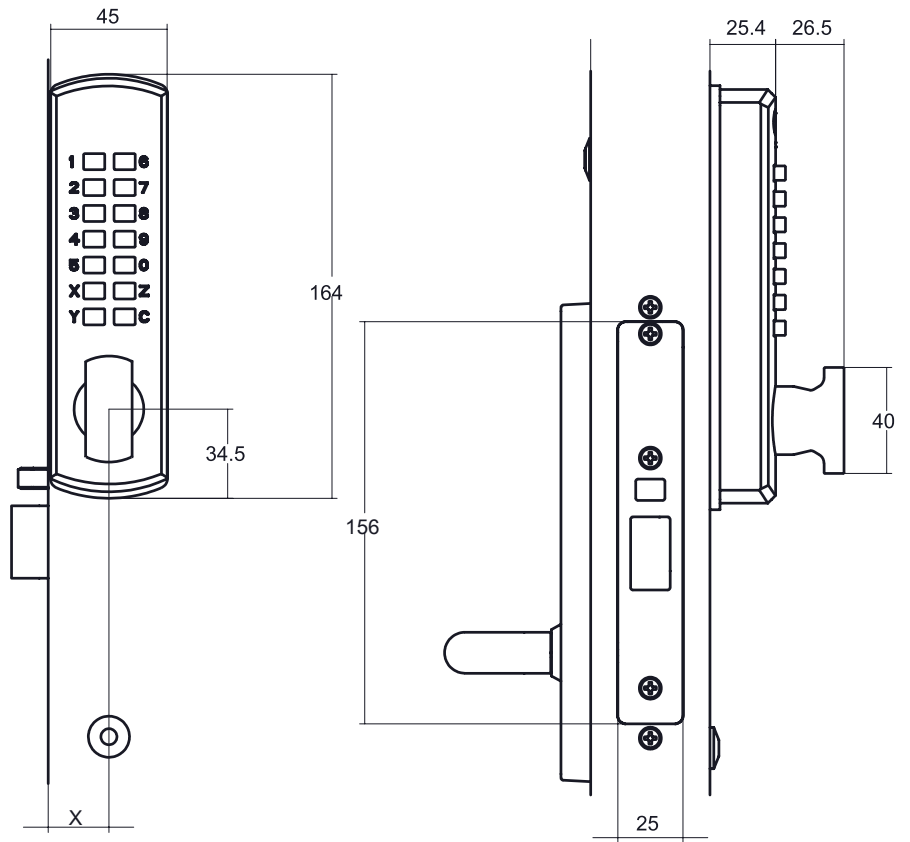

## Selector® 3782 Short Backset DX Digital Mortise Locks

Part Number	3782DX	4782DX	5782DX	6782DX
Dimension X	23	25.4	30	38

Note: Order by specifying 3782SS primary lock and 3782-DXKITSC.

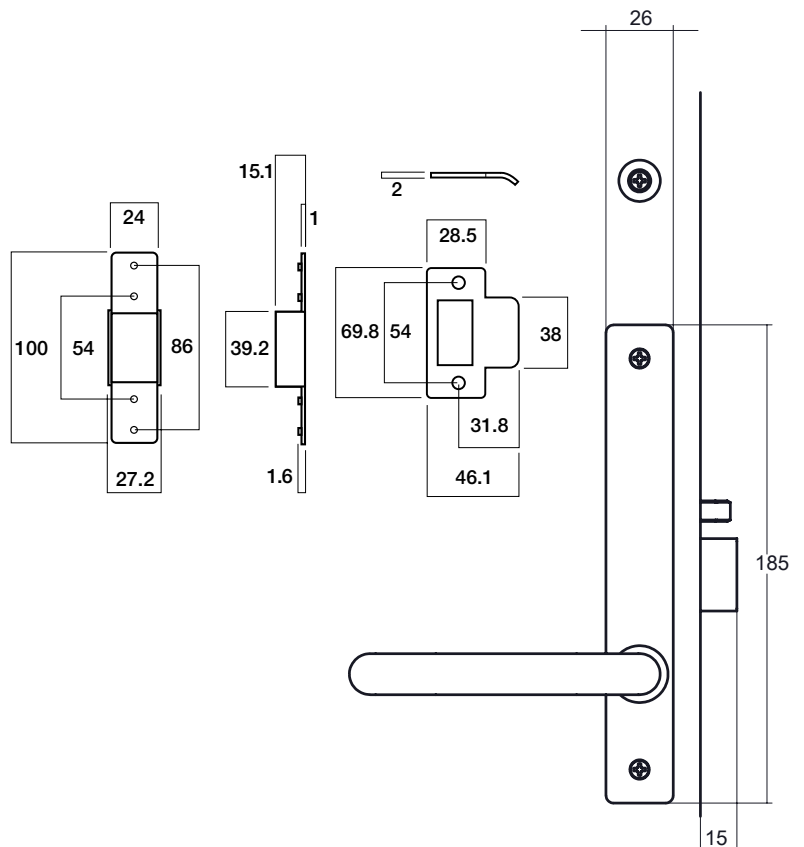

# Selector® 3782 Short Backset DX Digital Mortice Locks

## DX Digital Mortice Lock

**Part Number** 3782DX-

DX Digital outside, plate furniture inside.

**Outside:** Opened by DX Digital with code.

**Inside:** Opened by handle at all times.

This function requires the locking bar to be positioned in the locked position once lock is set.

## DX Digital Mortice Lock with Holdback by Cylinder#

**Part Number** 3782DXV

DX Digital outside, plate furniture and cylinder inside.

**Outside:** Opened by DX Digital with code.

**Inside:** Opened by handle at all times. Holdback activated by key. Key retracts latch after releasing holdback.

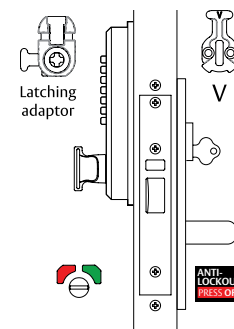
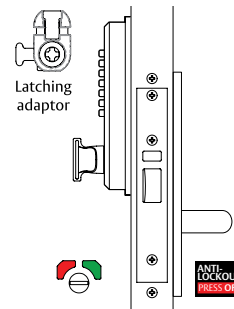

### Notes:

All drawings shown are in right hand configuration. Part numbers shown above are for 23mm backset lock, if 25.4mm is required substitute 3 for 4 i.e. 4782, or if 30mm or 38mm lock is required, substitute 3 for 5 or 6 respectively i.e. 5782, 6782

#Latch bolt can be held within the lock. Lock function recommended for use in holdback application.

### Warning:

The MkI Latching Adaptor (now part number 3770M1-ADAPTOR) can only be used with the MkI Selector Mortice Locks and the MkII Latching Adaptor (3770M2-ADAPTOR) can only be used with MkII Selector Mortice Locks.

For the 3780 Series short backset mortice locks, the MkI Latching Adaptor 3770M1-ADAPTOR must be used where a latching adaptor is required.

### Legend

Hub Setting



Anti-lockout Selection



Cam or Adaptor



X7

# Selector® 3782 Short Backset Key Override DX Digital Mortice Locks



## Description

Lockwood DX Digital Locksets provide a mechanical method of keyless entry.

For extra security when under forced attack, the inbuilt clutching mechanism allows the outside turnknob to rotate without operating or damaging the lock.

The factory set 4 digit code is easily changed to any 4, 5 or 6 digit code using the code changing kit provided with each lock.

Lockwood Digital DX Locksets are designed to control access into commercial areas.

As the digital lockset utilizes mechanical operation, electrical wiring is not required.

## Product Details

<b>Door Thickness</b>	43 to 46mm for metal doors
<b>Finish</b>	Codepad: Satin Chrome Brushed (SC) Mortice Lock: Stainless Steel (SS)
<b>Codepad Assembly</b>	High purity zinc alloy, 45mm wide, 164mm high, 52mm projection
<b>Latch</b>	Stainless steel with 15mm projection

Note: As suitability of lever will be influenced by the lock backset, refer to chart for Lever/Backset compatibility Lockwood Door Handle Catalogue. Lockwood 4800 and 5800 Series (ordered separately).

## Backset

Open-out door: 23, 25.4, 30 and 38mm.  
Open-in door: 38mm recommended.  
Installation of 23, 25.4 or 30mm on open-in doors would require the door stop to be machined to clear the digital pad.

## Inside Function

Opened by lever handle at all times.

## Holdback Function

Holdback function is available, this requires the inclusion of an internal cylinder.

# Selector® 3782 Short Backset Key Override DX Digital Mortise Locks



Exterior

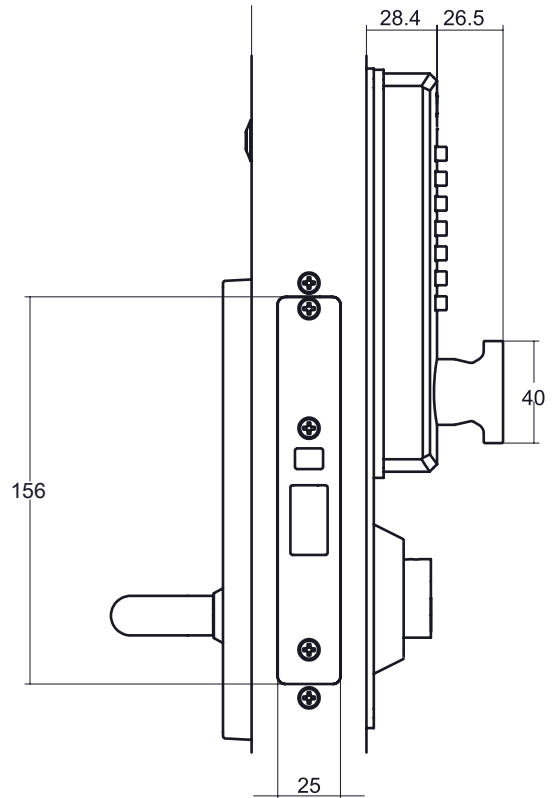
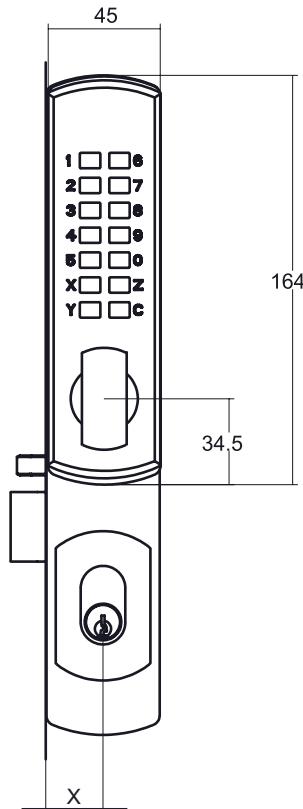

Interior

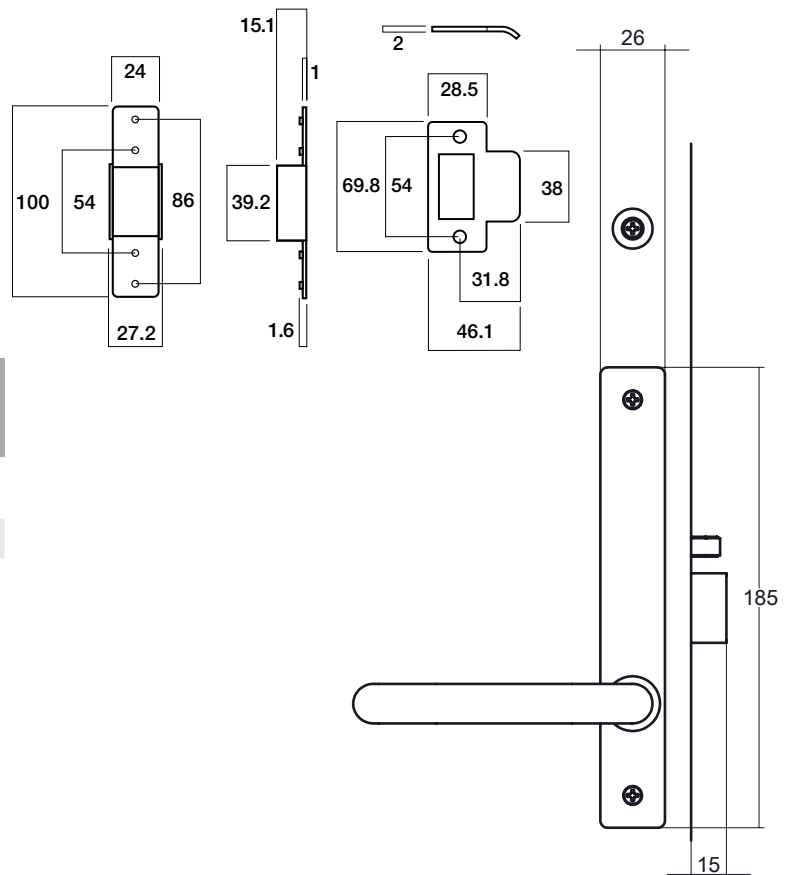

## Selector® 3782 Short Backset Key Override DX Digital Mortise Locks

Part Number	3782DXKO	4782DXKO	5782DXKO	6782DXKO
Dimension X	23	25.4	30	38

**Note:** Order by specifying 3782SS primary lock and 3782-DXKOKITSC. Cylinders must be ordered separately. Key Override DX Digital kit only suits 43-46mm door thickness.

# Selector® 3782 Short Backset Key Override DX Digital Mortice Locks

## DX Digital Mortice Lock with Key Override

**Part Number** 3782DXKO-

DX Digital and lower cylinder outside, plate furniture inside.  
**Outside:** Opened by DX Digital with code or key at all times.

**Inside:** Opened by handle at all times.

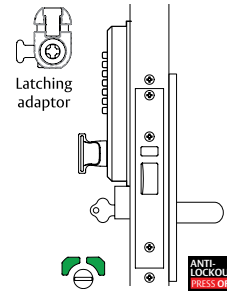

## DX Digital Mortice Lock with Key Override and Internal Cylinder#

**Part Number** 3782DXKOV

DX Digital and lower cylinder outside, plate furniture and cylinder inside.

**Outside:** Opened by DX Digital with code or key at all times.

**Inside:** Opened by handle at all times. Holdback activated by key. Key retracts latch after releasing holdback.

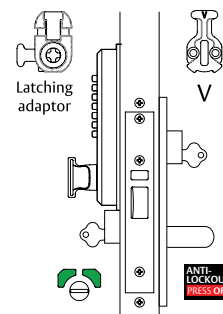

### Notes:

All drawings shown are in right hand configuration. Part numbers shown above are for 23mm backset lock, if 25.4mm is required substitute 3 for 4 i.e. 4787, or if 30mm or 38mm lock is required, substitute 3 for 5 or 6 respectively i.e. 5787, 6787

#Latch bolt can be held within the lock. Lock function recommended for use in holdback application.

### Warning:

The MkI Latching Adaptor (now part number 3770M1-ADAPTOR) can only be used with the MkI Selector Mortice Locks and the MkII Latching Adaptor (3770M2-ADAPTOR) can only be used with MkII Selector Mortice Locks. For the 3780 Series short backset mortice locks, the MkI Latching Adaptor 3770M1-ADAPTOR must be used where a latching adaptor is required.

### Legend

**Hub Setting**



**Anti-lockout Selection**



**Cam or Adaptor**



# Selector® 3780 Series Accessories

## Dual Entry Kit

Part Number	Application
3787-KIT570E	For new 3787 dual entry applications

Dual Entry Kit include: Lower cylinder mounting plate, spindle cam and mounting screws.

Cylinders must be ordered separately. Dual Entry Kit only suitable on doors 43-46mm thick.

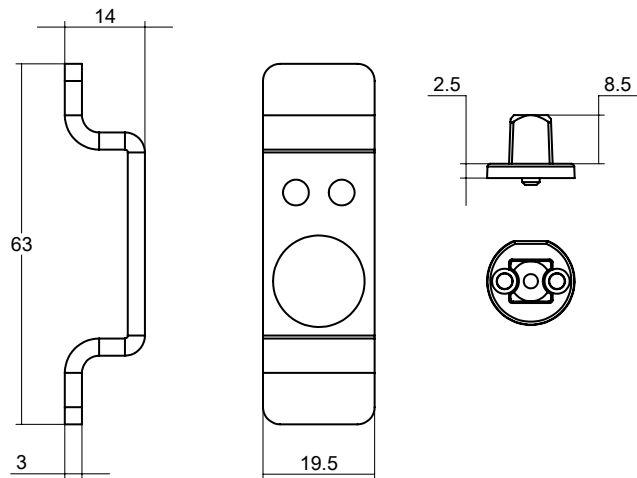

## DX Digital Kits

Part Number	Application
3782-DXKITSC	DX Digital Kit
3782-DXKOKITSC	DX Digital with Key Override Kit

DX Digital kits include: Digital codepad, mounting plate, codepad spindle, associated mounting screws and a latching adaptor.

Cylinders and door furniture (4800 or 5800 series) must be ordered separately.

DX Digital with Key Override only suitable on doors 43-46mm thick.

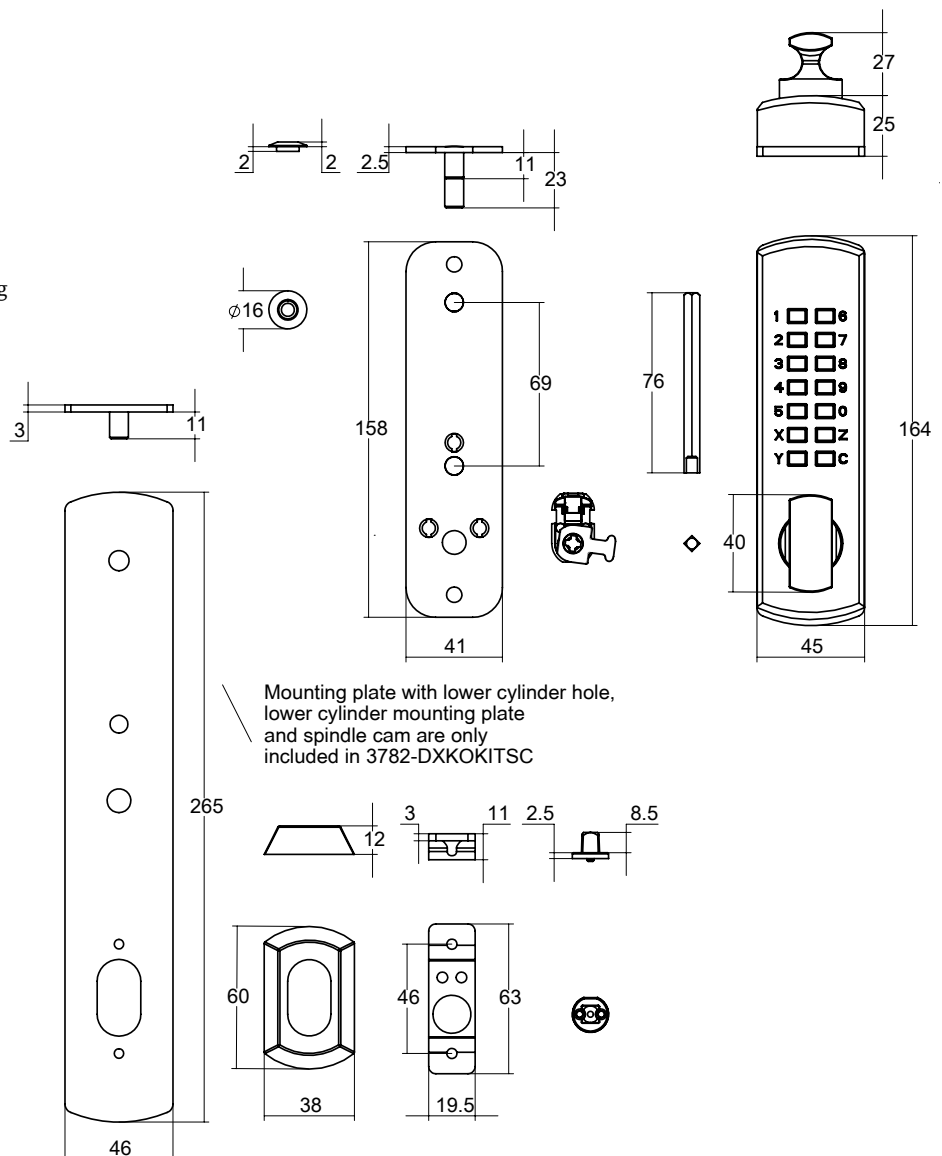

# Selector® 3780 Series Accessories

## Alternative Finish Kits

Part Number	Finish
3782-FINKITCP*	Chrome Plate
3782-FINKITPC	Powder Coat

Finish kits include: Strike, faceplate and screws.  
Finish kits are not suitable for use with 25.4mm backset 4782 lock.

\*Screws not included.

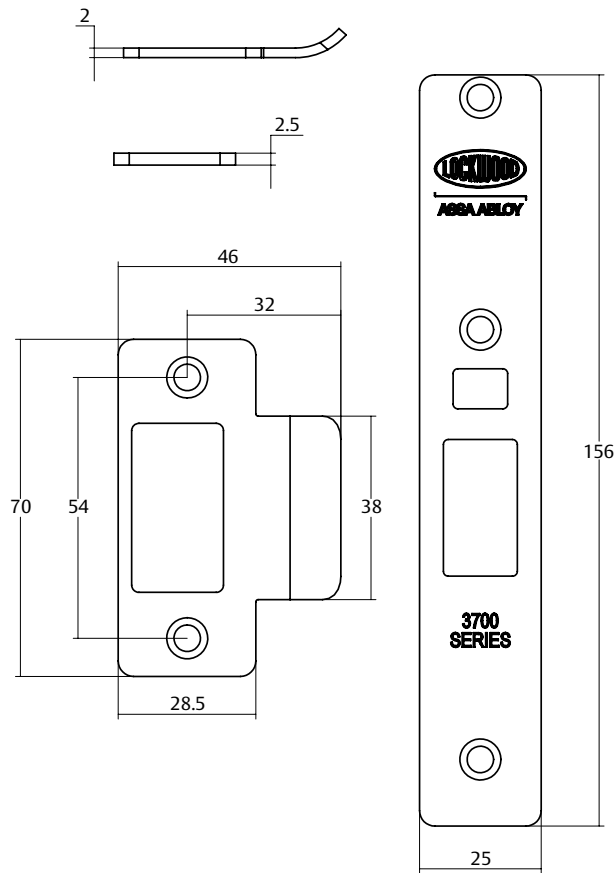

## Timber Door Fixing Kit

Part Number	Finish
3782-TFKITSS*	Stainless Steel
3782-TFKITCP*	Chrome Plate
3782-TFKITPB	Polished Brass

Timber door fixing kits are not suitable for use with 25.4mm backset 4782 lock.

\*Faceplate screws not included

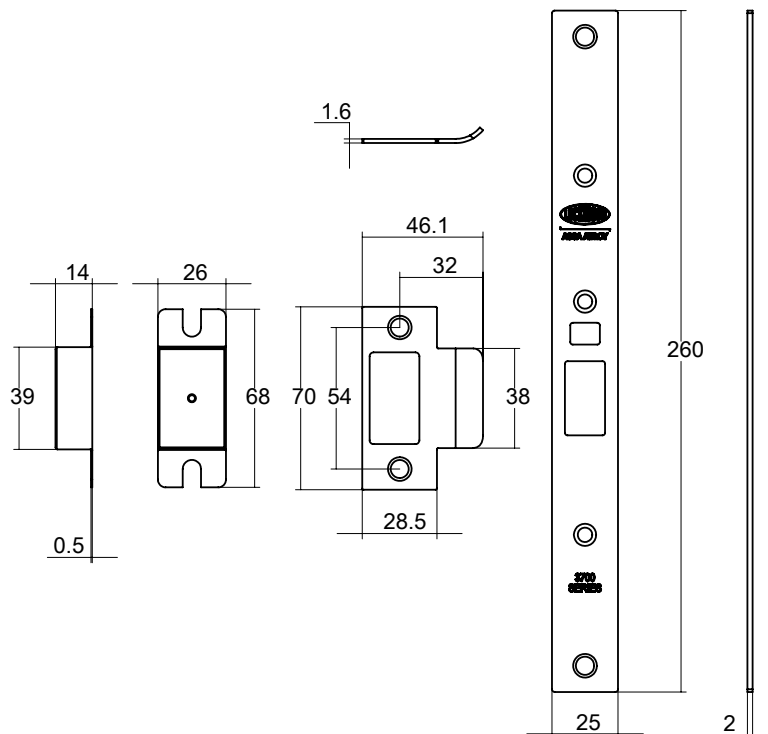



# Selector® 3780 Series Accessories

## ES2100 Electric Strike Faceplates

Part Number	Application
3782-2100SS	To suit 3780 Series
3782TF-2100SS*	To suit 3780 Series with Timber Door Fixing

To work in conjunction with the Lockwood Padde Series ES2100 electric strike for door position monitoring.

\* Can be used directly with a 3782SS primary lock  
- No additional TF fixing kit is required.

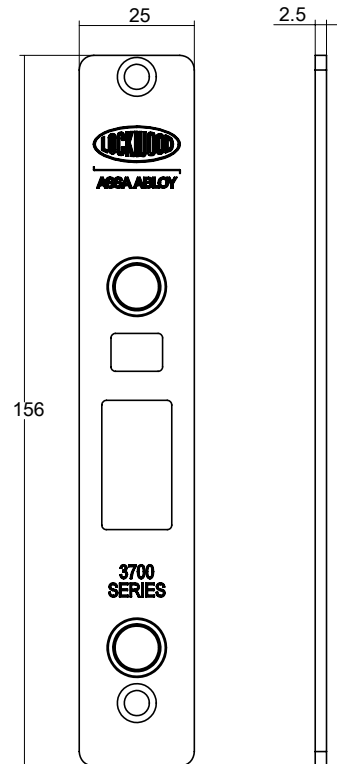

## Security Faceplate Screw Kit

Part Number	Application
3782-SECKIT	To suit 3780 Series

Kit contains five replacement faceplate screws with tamper resistant TR20 Torx drive heads.

# Selector® 3780 Series Accessories

## Short/Extended Lipped Strikes

Part Number	Lip Length A	Strike Length B
3782-STK32XX	32mm	46.1mm
3782-STK74XX*	74mm	88.5mm

To order, add finish code to part number.

XX designates the finish.

**SS** - Stainless Steel, **CP** - Chrome Plate, **PB** - Polished Brass

\*Only available in Stainless Steel (**SS**) finish.

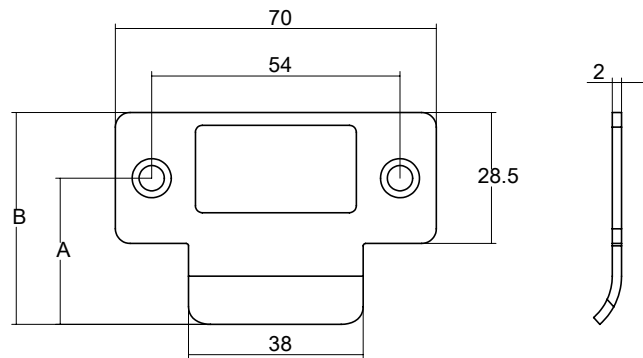

## Fabricator Strikes

Part Number	Lip Length A	Strike Length B
3782-FSTK32SS	32mm	47.2mm
3782-FSTK64SS	64mm	80.2mm

Stainless Steel D shaped strike.

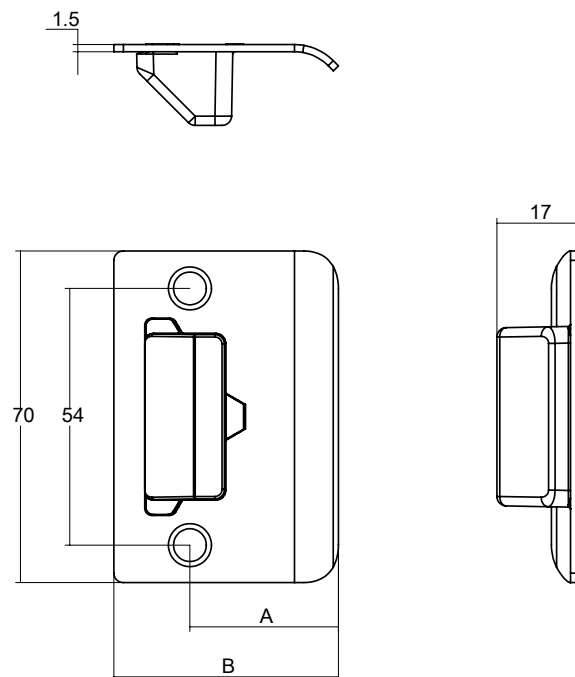

# Selector® 3780 Series Accessories

## Retrofit Strike Kits

Part Number	Finish
3782-RFSTKCP	Chrome Plate
3782-RFSTKSC	Satin Chrome Brushed

For replacement of existing installations where Lockwood 5900, 595 and Astra Short Backset are used. For replacement of Astra specify 25.4mm backset.

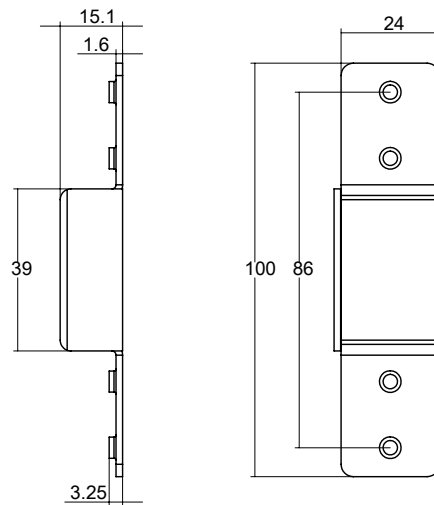
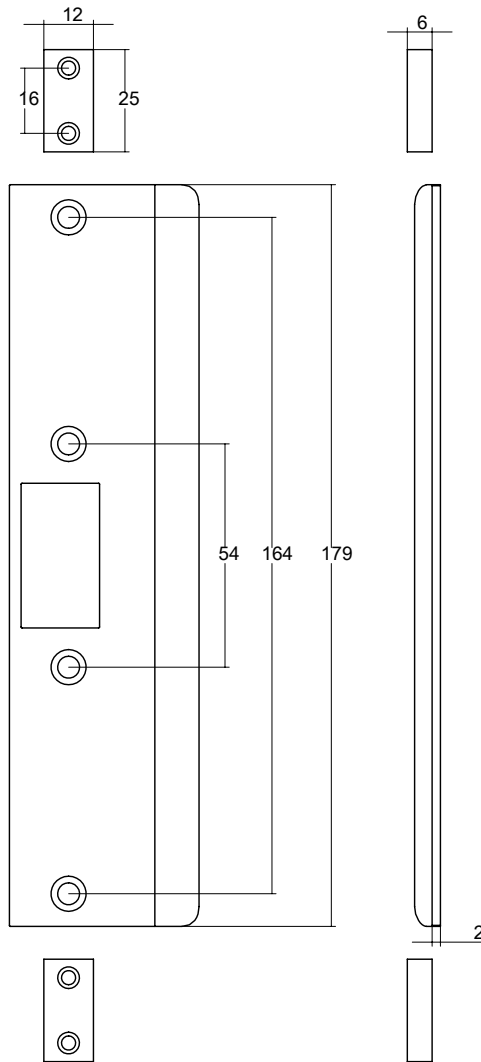

# Selector® 3780 Series Accessories

## Rebate Kits

Part Number	Finish
5782-RK ##CP	Chrome Plate
5782-RK ##SS	Stainless Steel
5782-RK ##PB	Polished Brass

Rebate kits to suit 13mm rebated timber doors with minimum backset of 30mm.

To order, add door handing to part number.

Refer to door handing guide at the bottom of page.

## designates door handing.

**CW** - Clockwise

**ACW** - Anti-clockwise

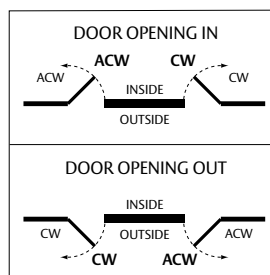
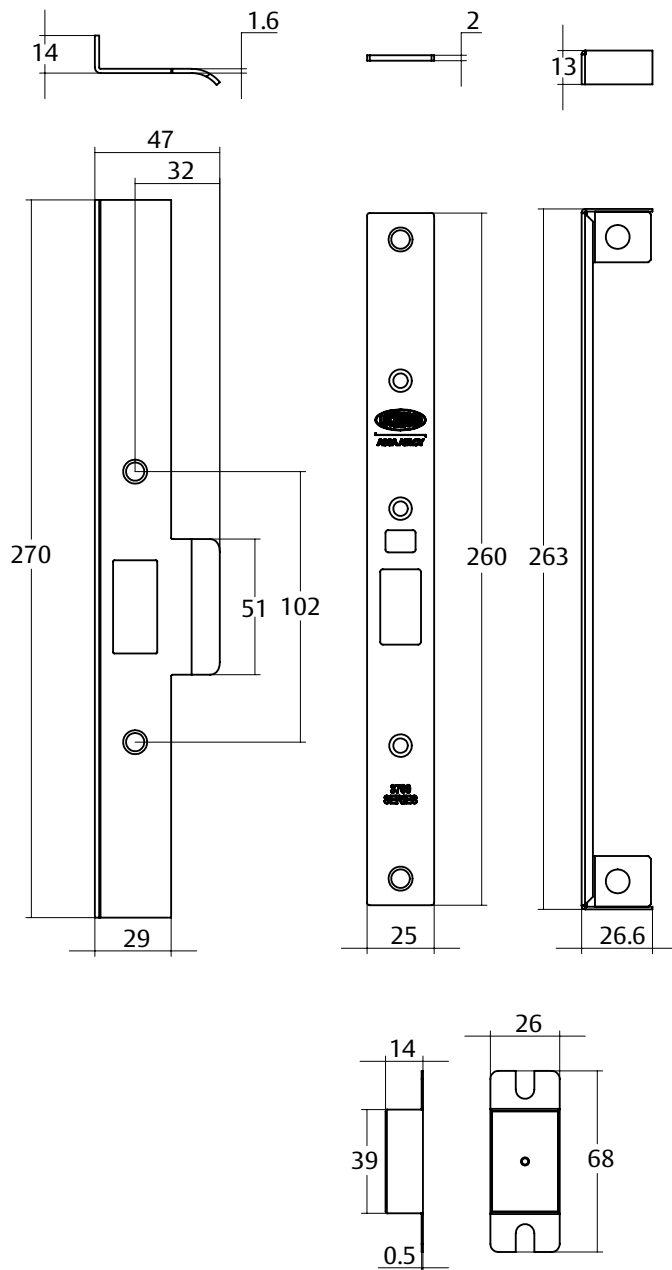

CW                      Left Hand open in  
(Clockwise)            Right Hand open out

ACW                     Left Hand open out  
(Anti-Clockwise)     Right Hand open in

# Selector® 3780 Series Accessories

## Mortice Lock Spindles

Part Number	Pack Size	Length "A"	Door Thickness	
			Min	Max
SP3570-5018	10	33mm	32	50
SP3570-5228	1	45mm	50	75
SP3570-5238	1	58mm	75	100
SP3570-5258	1	108mm	100	200

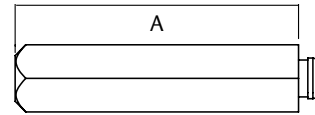
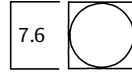

## Single Cylinder Assemblies

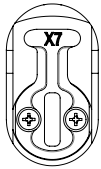

"X7" Cam Cylinder  
570C4/X7

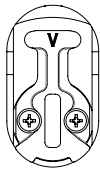

"V" Cam Cylinder  
570C4/V



3787 Lower Cylinder  
with Spindle Cam  
570EC4/87

## Cylinder Cams

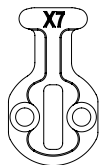

"X7" Cam  
SP3700/X7CAM

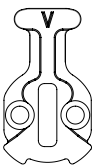

"V" Cam  
SP3700/VCAM

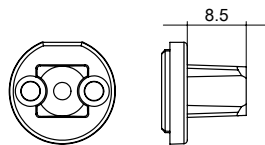

3787 Spindle Cam  
SP3787/CAM

## Adaptors

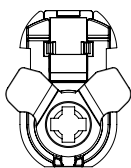

Locking Adaptor  
3772-ADAPTOR

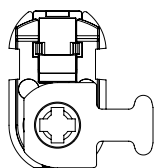

Latching Adaptor  
3770M1-ADAPTOR

# Selector® 3780 Series Cam and Adaptors Function Chart

## Selector® 3780 Series Cam and Adaptors Function Chart

Selector® 3780 Series	Function Description	Primary Lock	Outside Cylinder Cam/Adaptor	Inside Cylinder Cam/Adaptor	Kit
<b>Selector® 3780 Nightlatches</b>					
3780-TSS	Nightlatch with Turn	3780TSS	-	3770M1-ADAPTOR	
3780X-SS	Nightlatch with Cylinder	3782SS	X7	-	
3780XTSS	Nightlatch with Cylinder and Turn	3780TSS	X7	3770M1-ADAPTOR	
3780XXSS	Nightlatch with Double Cylinder	3782SS	X7	X7	
<b>Selector® 3782 Escape Locks</b>					
3782SS	Escape Primary Lock	3782SS	-	-	
3782-SS	Escape Lock	3782SS	-	-	
3782V-SS#	Anti-vandal Escape Lock	3782SS	V	-	
3782VTSS#	Anti-vandal Escape Lock with Turn	3782TSS	V	3772-ADAPTOR	
3782X-SS	Key Entry Escape Lock	3782SS	X7	-	
3782XTSS#	Key Entry Escape Lock with Turn	3782TSS	X7	3772-ADAPTOR	
3782-VSS#	Escape Lock with Internal Cylinder	3782SS	-	V	
3782-TSS#	Escape Lock with Turn	3782TSS	-	3772-ADAPTOR	
3782XVSS#	Key Entry Escape Lock with Internal Cylinder	3782SS	X7	V	
3782-TASS	Anti-lockout Escape Lock with Turn	3782TSS	-	3772-ADAPTOR	
3782VTASS	Anti-lockout Anti-vandal Escape Lock with Turn	3782TSS	V	3772-ADAPTOR	
<b>Selector® 3784 Combination Locks</b>					
3784SS	Passage Latch	3782SS	-	-	
3784VTSS#	Anti-vandal Lock with Turn	3782TSS	V	3772-ADAPTOR	
3784VVSS#	Anti-vandal Lock with Internal Cylinder	3782SS	V	V	
3784XVSS#	Key Entry Lock with Internal Cylinder	3782SS	X7	V	
3784XXSS	Key Entry Double Cylinder Lock	3782SS	X7	X7	
3784-TSS	Combination Lock with Turn	3782TSS	-	3772-ADAPTOR	
3784-TASS	Anti-lockout Combination Lock with Turn	3782TSS	-	3772-ADAPTOR	
3784VTASS	Anti-lockout Anti-vandal Lock with Turn	3782TSS	V	3772-ADAPTOR	
3784VVASS	Anti-lockout Anti-vandal Lock with Internal Cylinder	3782SS	V	V	
<b>Selector® 3787 Dual Entry Locks</b>					
3787X-SS	Dual Entry Lock	3782SS	X7, 3787 SPINDLE CAM	-	3787-KIT570E
3787V-SS	Dual Entry Lock with Lower Cylinder Lockout	3782SS	V, 3787 SPINDLE CAM	-	3787-KIT570E

# Selector® 3780 Series Cam and Adaptors Function Chart

## Selector® 3780 Series Cam and Adaptors Function Chart

Selector® 3780 Series	Function Description	Primary Lock	Outside Cylinder Cam/Adaptor	Inside Cylinder Cam/Adaptor	Kit
<b><i>Selector® Privacy Locks</i></b>					
3782-TSS	Escape Privacy Lock	3782TSS	-	3772-ADAPTOR	
3782-TASS	Anti-lockout Escape Privacy Lock	3782TSS	-	3772-ADAPTOR	
3784-TSS	Privacy Lock	3782TSS	-	3772-ADAPTOR	
3784-TASS	Anti-lockout Privacy Lock	3782TSS	-	3772-ADAPTOR	
3787-TSS	Key Entry Privacy Lock	3782TSS	3787 SPINDLE CAM	3772-ADAPTOR	3787-KIT570E
3787-TASS	Key Entry Anti-lockout Privacy Lock	3782TSS	3787 SPINDLE CAM	3772-ADAPTOR	3787-KIT570E
<b><i>Selector® 3782 DX Digital Locks</i></b>					
3782DX-SS	DX Mechanical Digital Mortice Lock	3782SS	3770M1-ADAPTOR	-	3782-DXKITSC
3782DXVSS#	DX Mechanical Digital Mortice Lock with Internal Cylinder	3782SS	3770M1-ADAPTOR	V	3782-DXKITSC
3782DXKO-SS	DX Mechanical Digital Mortice Lock with Key Override	3782SS	3770M1-ADAPTOR	-	3782-DXKOKITSC
3782DXKOVSS#	DX Mechanical Digital Mortice Lock with Key Override and Internal Cylinder	3782SS	3770M1-ADAPTOR	V	3782-DXKOKITSC

**Note:** Items in Italics are Primary Locks and can be purchased from ASSA ABLOY.

#Lock function suitable for holdback application. Holdback can be activated at any time - unless anti-lockout is selected.

Cylinders sold separately, purchased configurations include adaptors as required.

Only 30mm and 38mm backset locks are suitable in DXs configurations on opening in doors.

# Synergy Series Conversion Chart

## Synergy Series Conversion Chart

Synergy Series	Selector® 3780 Series	Function Description	Note
<b>Escape Locks</b>			
3582SC	3782SS	Escape Lock	
3582-ASC			3782 series primary lock has anti-lockout functionality. To set anti-lockout function, refer to setting and operating instructions.
3582-T#SC	3782-TSS	Escape Privacy Lock	
3582WA#SC	3782VTASS	Anti-lockout Anti-vandal Escape Lock with Turn	V cam has the functionality of locking lock just as the W cam. V cam also retracts bolt after unlocking lock.
3582WT#SC	3782VTSS	Anti-vandal Escape Lock with Turn	V cam has the functionality of locking lock just as the W cam. V cam also retracts bolt after unlocking lock.
3582X-#SC	3782X-SS	Key Entry Escape Lock	X7 cam has the functionality of retracting bolt and locking lock. Does not have unlocking functionality.
3582XT#SC	3782XTSS	Key Entry Escape Lock with Turn	X7 cam has the functionality of retracting bolt and locking lock. Does not have unlocking functionality.
3582XZ#SC	3782XVSS	Key Entry Escape Lock with Internal Cylinder	V cam has the functionality of locking lock just as the Z cam. V cam also retracts bolt after unlocking lock. X7 cam has the functionality of retracting bolt and locking lock. Does not have unlocking functionality.
3582-Z#SC	3782-VSS	Escape Lock with Internal Cylinder	V cam has the functionality of locking lock just as the Z cam. V cam also retracts bolt after unlocking lock.
3582Z-#SC	3782V-SS	Anti-vandal Escape Lock	V cam has the functionality of locking lock just as the Z cam. V cam also retracts bolt after unlocking lock.
<b>Combination Locks</b>			
3584ET#SC	3784-TSS	Combination Lock with Turn	
3584#SC	3784SS	Passage Latch	
3584-T#SC	3784-TSS	Combination Lock with Turn	
3584WT#SC	3784VTSS	Anti-vandal Lock with Turn	V cam has the functionality of locking lock just as the W cam. V cam also retracts bolt after unlocking lock.
3584XX#SC	3784XXSS	Key Entry Double Cylinder Lock	X7 cam has the functionality of retracting bolt and locking lock. Does not have unlocking functionality.
3584XZ#SC	3784XVSS	Key Entry Lock with Internal Cylinder	V cam has the functionality of locking lock just as the Z cam. V cam also retracts bolt after unlocking lock. X7 cam has the functionality of retracting bolt and locking lock. Does not have unlocking functionality.
3584Z-#SC	3784V-SS	Anti-vandal Lock	V cam has the functionality of locking lock just as the Z cam. V cam also retracts bolt after unlocking lock.
3584ZZ#SC	3784VSS	Anti-vandal Lock with Internal Cylinder	V cam has the functionality of locking lock just as the Z cam. V cam also retracts bolt after unlocking lock.
<b>Timber Fixing</b>			
3592SC			For timber fixing, specify the lock with an additional line 3782-TFKITxx where xx designates the required finish.



# Synergy Series Conversion Chart

## Synergy Series Conversion Chart

Synergy Series	Selector® 3780 Series	Function Description	Note
<b>Extended Lip Strikes</b>			
SP3580-53SC	3782-STK32SS	3782 STANDARD STRIKE 32MM LIP PK=10	
SP3580-53CP	3782-STK32CP	3782 STANDARD STRIKE 32MM LIP PK=10	
SP3580-53PB	3782-STK32PB	3782 STANDARD STRIKE 32MM LIP PK=10	
SP3580-A53SC	3782-STK74SS	3782 LONG LIP STRIKE 74MM LIP	
SP3580-52	3782-STKBOX	3782 STRIKE BOX PK=10	
<b>Surface Mounted Fabricator Lip Strikes</b>			
SP3P80-053SS	3782-FSTK32SS	3782 FABRICATOR STRIKE KIT 32MM LIP	
SP3P80-153SS	3782-FSTK64SS	3782 FABRICATOR STRIKE KIT 64MM LIP	
<b>Retrofit Strikes</b>			
3580-1902SC	3782-RFSTKSC	3782 RETROFIT STRIKE KIT	
3580-1902CP	3782-RFSTKCP	3782 RETROFIT STRIKE KIT	
3580-1902PB	3782-RFSTKPB	3782 RETROFIT STRIKE KIT	
<b>Rebate Kits</b>			
3580-2902ACWSC	5782-RKACWSS	5782/6782 REBATE KIT ANTICLOCKWISE	
3580-2902ACWCP	5782-RKACWCP	5782/6782 REBATE KIT ANTICLOCKWISE	
3580-2902ACWPB	5782-RKACWPB	5782/6782 REBATE KIT ANTICLOCKWISE	
3580-2902CWSC	5782-RKCWSS	5782/6782 REBATE KIT CLOCKWISE	
3580-2902CWCP	5782-RKCWCP	5782/6782 REBATE KIT CLOCKWISE	
3580-2902CWPB	5782-RKCWPB	5782/6782 REBATE KIT CLOCKWISE	

# Selector® 3780 Series Short Backset Mortice Locks Functioning Matrix

## Functioning Matrix

Sample part number 3782VTASS is made up of seven elements.  
The description of this part number is an Anti-lockout Anti-vandal escape lock with cylinder and turn in satin stainless steel finish. Choose your product by selecting an option from each element.

Backset	Series	Platform	Function	Sub Function	Anit-lockout Selection	Finish
3	7	8	2	VT	A	SS

### Backset

23mm	3
25.4mm	4
30mm	5
38mm	6

### Series

Selector® Series Mortice Locks	7
--------------------------------	---

### Platform

Short Backset	8
---------------	---

### Functions

Nightlatch	0
Escape Lock	2
Combination Lock	4
Dual Entry Lock	7

### Sub Function

e.g. Outside	Inside
V	T
Locking and Latching Cylinder with V Cam	V
Latching Cylinder with X7 Cam	X
Turnbutton Adaptor	T
No Sub Function	-
DX Digital	DX
DX Digital with Key Override	DXKO

### Anit-lockout Selection

Neutral	
Anti-lockout	A

### Finish

Stainless Steel	SS
-----------------	----

## Code

- 1. Backset:** Nominate backset as required, for example 3 = 23mm backset.
- 2. Function:** Select function, for example 782 = Escape Lock
- 3. Sub Function:** Determine sub function requirements for both exterior and interior.  
For example:  
Exterior – Locking function required – specify V (cylinder).  
Interior – Turnknob function required – specify T (turnbutton adaptor).
- 4. Anti-lockout Selection:** Determine if anti-lockout function is needed.  
For example:  
Anti-lockout - Specify A
- 5. Finish:** Select appropriate finish, e.g. SS  
Other finishes available by specifying finish kits.

**We take the worry out of  
protecting what's valuable to you.**  
**Lockwood: *no worries***<sup>®</sup>





**ASSA ABLOY**

**Lockwood** is the leading brand in the Australian locking industry. With an established reputation for high quality products, this iconic brand provides a wide range of locking solutions to residential housing, commercial, semi-commercial, building and industrial application markets. Lockwood is supported by an extensive distribution and after-sales support network. Our customers include retailers, architects, trade and industrial personnel, locksmiths and security dealers.

**ASSA ABLOY** is the global leader in door opening solutions, dedicated to satisfying end-user needs for security, safety and convenience.

**ASSA ABLOY** is represented in all major regions, in both mature and emerging markets, with leading positions in Australia, Europe and North America.

**25YEAR  
MECHANICAL  
WARRANTY**

### **The Lockwood 25 Year Mechanical Warranty**

Our belief that we manufacture the finest premium products available in today's market place is backed by the Lockwood 25 Year Mechanical Warranty, ensuring that Lockwood continues to keep Australians safe by delivering security and peace of mind.

For warranty terms and conditions, please visit [www.lockweb.com.au](http://www.lockweb.com.au) or call **1300WARRANTY**

**ASSA ABLOY Australia Pty Ltd**  
235 Huntingdale Road  
Oakleigh, Victoria, 3166  
Australia

**1300 LOCK UP (1300 562 587)**  
[lockweb.com.au](http://lockweb.com.au)

**ASSA ABLOY New Zealand Ltd**  
6 Armstrong Road  
Albany, Auckland, 0632  
New Zealand

[info.nz@assaabloy.com](mailto:info.nz@assaabloy.com)  
Telephone +64 9415 7111  
[assaabloy.co.nz](http://assaabloy.co.nz)

### **Disclaimer**

Whilst every effort has been made to ensure that the information (including product images and drawings) contained in this brochure is accurate at the time of publication, ASSA ABLOY Australia Pty Limited ("ASSA ABLOY") recommends that you consult ASSA ABLOY or its agents prior to placing an order to ascertain current information on specific products, as ASSA ABLOY reserves the right to make changes without notice. ASSA ABLOY will not be liable for any injury, loss or damage whatsoever, arising from any errors or omissions in the information contained in the brochure or arising from the use or application of the information contained herein. © 2016 copyright by ASSA ABLOY All rights reserved

