

Panic Exit Devices



We take the worry out of
protecting what's valuable to you.
Lockwood: *no worries*[®]



ASSA ABLOY

25YEAR

MECHANICAL
WARRANTY

www.lockweb.com.au

Contents



FLUID Series Exit Device
Panic Exit Hardware

page 5



FLUID Series Exit Mortice Lock

page 7



FLUID Series Exit Accessories

page 9



9000/9100 Series
Electromechanical Rim Type
Panic Exit Device

page 14



9300/9400 Series
Electromechanical Rim Vertical
Type Panic Exit Device

page 16

FLUID Panic Exit Devices

Typical Door Installations

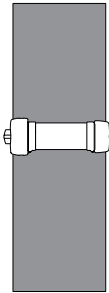

Single Door with Rim Device
FE109/0HSIL
FE112/0HSIL

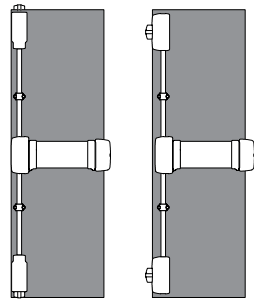

2 Point - Single Door
FE209/0VSIL
FE209/0HSIL
FE212/0VSIL
FE212/0HSIL

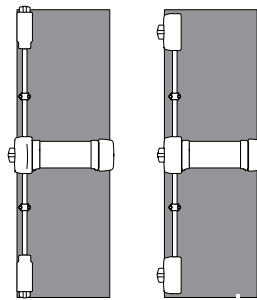

3 Point - Single Door
FE309/0VSIL
FE309/0HSIL
FE312/0VSIL
FE312/0HSIL

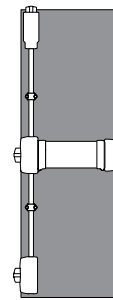

3 Point - Single Door
Combination.
Order FESP0045
& FESP0046SIL

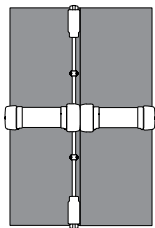

Pair of Rebated Doors
1 Vertical Device and
1 Rim Device
FE109/0HSIL
FE209/0VSIL
OR
FE112/0HSIL
FE212/0VSIL

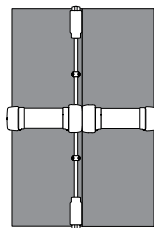

Pair of Rebated Doors
1 Vertical Device, 1 Mortice
Lock Device
FE109/0MSIL
FE209/0VSIL
OR
FE112/0MSIL
FE212/0VSIL

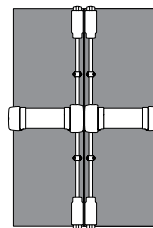

Pair of Non-rebated Doors
with 2 Vertical Devices
2 x FE209/0VSIL
2 x FE212/0VSIL

*Rebate Kit 3772-RK32
** to be ordered seperately

FLUID Series Exit Device



Description

The next generation in the Lockwood Panic Exit Device range, the FLUID Series provides for the fundamental means of escape whilst offering a completely unique locking mechanism and design aesthetic.

With this type of unique innovation, ASSA ABLOY continues to evolve in standardising the market. The Lockwood FLUID Exit Device range combines ergonomics and performance with a completely new type of axis mechanism and high security bolt system.

Protect. Evacuating people safely

Secure. High vandal resistance

Optimise. A simple and efficient installation process

Features and Specifications

- Brushed Stainless Steel Bolt
- High level of resistance. Up to 500kg to each latching point.
- Tested to 1,000,000 cycles
- Auxiliary bolt activation from 1mm
- Effortless opening < 20N required
- Available in both vertical and horizontal latching positions in 2/3 point configurations
- Bar can be cut down to 350mm
- New fixing bracket and template design reduces installation time by up to 50%

Latching



Horizontal Latching



Vertical Latching

Standards and Compliance

Successfully tested on fire door assemblies in accordance with Australian Standard AS1905.1-2005. Fire Resistant Doorsets.



For certain fire door assemblies through fix bolts may be required (FE0060). Refer to the specific fire door manufacturer for details.

Conforms to the standards as set out in CE EN1125 -2008.

FLUID Series Exit Device

FE100 Series Exit Device Single Point

Part Number	Description
FE109/0HSIL	1 Point Rim Exit Device 900mm
FE112/0HSIL	1 Point Rim Exit Device 1200mm
FE109/1HSIL	1 Point Rim Exit Device Cylinder Dogging 900mm
FE112/1HSIL	1 Point Rim Exit Device Cylinder Dogging 1200mm

The FE Single Point Series is a one point locking device which provides for an escape function at all times by way of pushing a horizontal bar fitted to the door.

For single or double leaf doors.
To suit two standard widths 900mm & 1200mm doors.
Cylinder Dogging optional.

Note: Euro Profile Cylinder sold separately

For applications requiring an external trim, please order separately
FE5000*** Series Trim Kit

External nightlatch (cylinder only) available Dec 2017

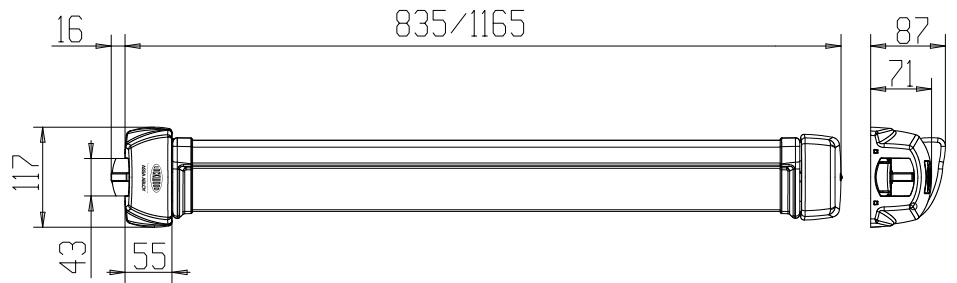

FLUID Series Exit Device

FE200 Series Exit Device Two Point

Part Number	Description
-------------	-------------

FE209/0HSIL	2 Point Exit Device Horizontal Latch 900mm
FE212/0HSIL	2 Point Exit Device Horizontal Latch 1200mm
FE209/1HSIL	2 Point Exit Device Horizontal Latch Cyl Dogging 900mm
FE212/1HSIL	2 Point Exit Device Horizontal Latch Cyl Dogging 1200mm
FE209/0VSIL	2 Point Exit Device Vertical Latch 900mm
FE212/0VSIL	2 Point Exit Device Vertical Latch 1200mm
FE209/1VSIL	2 Point Exit Device Vertical Latch Cyl Dogging 900mm
FE212/1VSIL	2 Point Exit Device Vertical Latch Cyl Dogging 1200mm

All 2 & 3 Point FLUID Panic Exit Devices come with rod covers as standard for optimal aesthetic appeal.

The FE Two Point Series is a dual point locking device which provides for an escape function at all times by way of pushing a horizontal bar fitted to the door.

For single or double leaf doors up to 2300mm.
 To suit two standard widths 900mm & 1200mm doors.
 Cylinder Dogging optional. Note: Euro Profile Cylinder sold separately.
 Vertical Rod Extension Kit available for doors up to 3000mm.
 Vertical and Horizontal latching options available.
 Rod covers included.

For applications requiring an external trim, please order separately FE5000*** Series Trim Kit.

For 2/3 point combination devices using Vertical and Horizontal latch solutions, please order the following separately:-

- FESP0045 Horizontal Latch Assembly
- FESP0046SIL Horizontal Latch Cover SIL LH/RH

External nightlatch (cylinder only) available Dec 2017

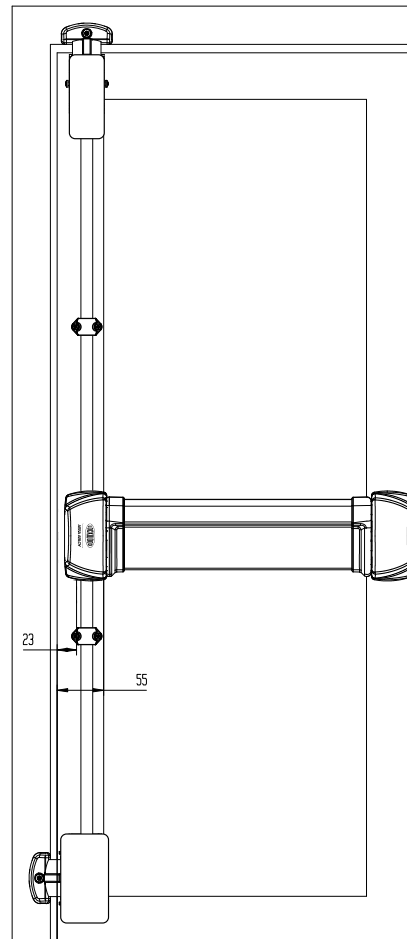

*2 point combination shown. Available in kit form only.

FLUID Series Exit Device

FE300 Series Exit Device Three Point

Part Number	Description
FE309/0HSIL	3 Point Rim Exit Device 900mm
FE312/0HSIL	3 Point Rim Exit Device 1200mm
FE309/1HSIL	3 Point Rim Exit Device Cylinder Dogging 900mm
FE312/1HSIL	3 Point Rim Exit Device Cylinder Dogging 1200mm
FE309/0VSIL	3 Point Exit Device Vertical Latch 900mm
FE312/0VSIL	3 Point Exit Device Vertical Latch 1200mm
FE309/1VSIL	3 Point Exit Device Vertical Latch Cyl Dogging 900mm
FE312/1VSIL	3 Point Exit Device Vertical Latch Cyl Dogging 1200mm

All 2 & 3 Point FLUID Panic Exit Devices come with rod covers as standard for optimal aesthetic appeal.

The FE Three Point Series is a triple point locking device which provides for an escape function at all times by way of pushing a horizontal bar fitted to the door.

For single or double leaf doors up to 2300mm.
 To suit two standard widths 900mm & 1200mm doors.
 Cylinder Dogging optional. Note: Euro Profile Cylinder sold separately.
 Vertical Rod Extension Kit available for doors up to 3000mm.
 Vertical and Horizontal latching options available
 Rod covers included.

For applications requiring an external trim, please order separately FE5000*** Series Trim Kit.

For 2/3 point combination devices using Vertical and Horizontal latch solutions, please order the following separately:-

- FESP0045 Horizontal Latch Assembly
- FESP0046SIL Horizontal Latch Cover SIL LH/RH

External nightlatch (cylinder only) available Dec 2017

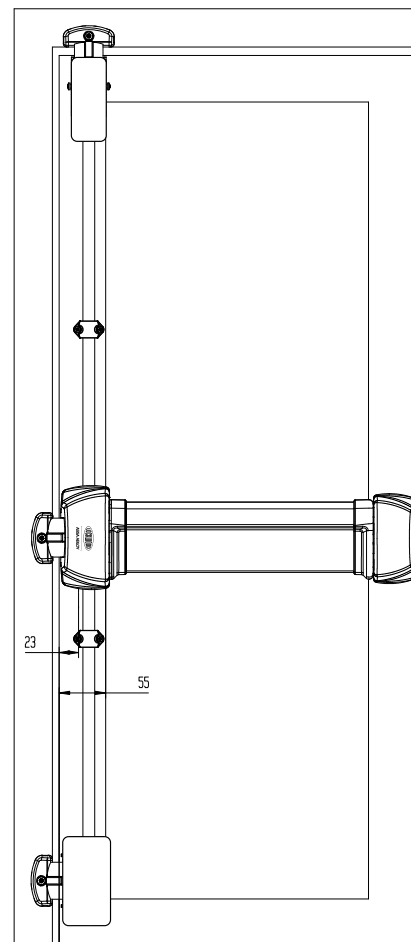

*3 point combination shown. Available in kit form only.

FLUID Mortice Lock Series



Description

The Lockwood FLUID Exit Mortice Lock series is engineered for the specific use with the Lockwood 3772 Selector MKII High Security Mortice Lock and 1800/2800 Series brass door furniture.

Operation

Inside: egress is always achieved by use of the FLUID Exit Panic Bar which will retract the latchbolt of the mortice lock.

Outside: entry by operation of lever handle.

Locking: Oval Cylinder to lock and unlock by turn of key. (Cylinder not supplied and must be ordered separately).

Product Details

Handing	Field Reversible
Backset	Available in 60mm, 89mm and 127mm backsets
Door Thickness	Standard doors between 32mm and 50mm
Sizes	900mm and 1200mm options
Outside Lever Handle	Lockwood 1800/2800 Plate Furniture Series. Please select lever from lever selection guide. (Sold Separately)
Cylinder	Compatible with 570 Cylinder type and the ability to adapt to most master key systems. (Sold Separately)
Electro Mechanical Locking option	Compatible for use with Lockwood 3572 ELM locking solutions where Electronic Access Control is nominated.

* For rebated double door assemblies, a 3772-RB32

** Rebate Kit will be required. Order Separately

*** The FLUID Exit Mortice Lock series is now supplied with the new and improved 3772 Selector MKII Mortice Lock providing for upgraded durability and security.

Note: please note that this configuration is not available in WHT (White)

Standards and Compliance



Successfully tested on fire door assemblies in accordance with Australian Standard AS1905.1-2005. Fire Resistant Doorsets.

Conforms to the standards as set out in CE EN1125 -2008.

FLUID Mortice Lock Series

FLUID Mortice Lock Series

Part Number	Description
FE109/OMSIL	FLUID Exit Mortice Lock Device 900mm
FE112/OMSIL	FLUID Exit Mortice Lock Device 1200mm
FE109/OELMSIL	FLUID Exit Electric Mortice Lock Device 900mm
FE109/OM/89/SIL	FLUID Exit 89mm Backset Mortice Lock 900mm
FE109/OM/127/SIL	FLUID Exit 127mm Backset Mortice Lock 900mm
FE112/OELMSIL	FLUID Exit Electric Mortice Lock Device 1200mm

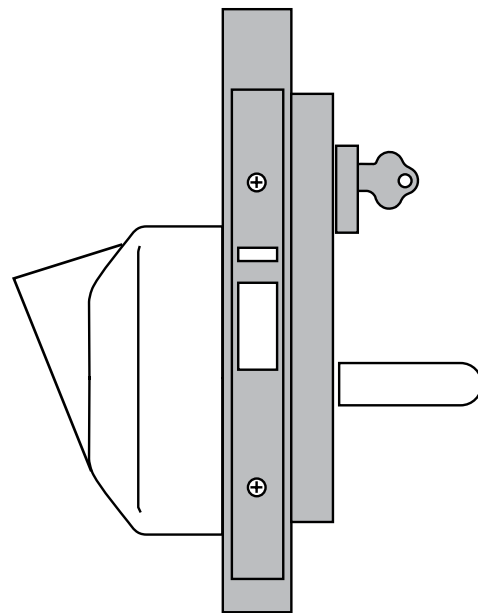

FLUID Accessories



Description

The next generation in Lockwood Panic Exit Hardware, the FLUID Exit Device comes with a selection of optional accessories to compliment the range and further provide a complete solution for all your egress requirements. These can be ordered separately to your FLUID Exit Device, please refer to the part numbering guide shown on the page.

FLUID Accessories

Cylinder Dogging

Part Number	Description
FE0010SIL	Cylinder Dogging Device SIL Euro (No Cyl)

Description

The Cylinder Dogging device is a simple mechanism designed to hold the push bar in the open position. Ideal for applications where access to the premises can be selected at any time and providing for a common thoroughfare door. The Cylinder Dogging device can be ordered inclusive with the FLUID Exit Device or can be supplied as an optional accessory.

With the innovative locking mechanism integral to the FLUID Exit range, the latches are always retained behind their strike plate providing a positive latched state to the door as all times. The Cylinder Dogging option will not change the state of latch and for this reason, we are able to provide this option as successfully tested on fire doors for the first time.

*FLUID Exit Device can be ordered with Cylinder Dogging as standard. See Part Numbering guide.

Field Reversible

*Euro Half Cyl sold separately



Vertical Rod Extension Kit

Part Number	Description
FE0050SIL	Vertical Rod Extension Kit 3000mm

Description

For doors exceeding 2300mm in height, the FE0050SIL - Vertical Rod Extension Kit is designed as an addition to the vertical rod exit device and can be used in applications of up to 3000mm. To be ordered separately.

*when using an extension kit, please note that rod covers are not available for this kit.

Available in SILVER only. (Black & White finishes available on request)

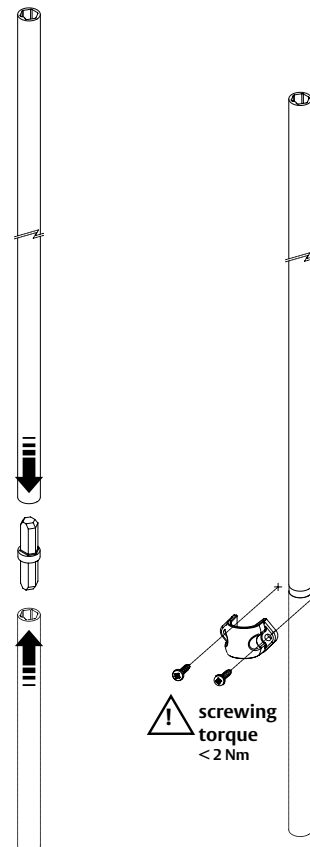

External Lever Trim

Part Number	Description
FE5000SIL	FLUID External Lever Trim (No Cyl)

Description

The FLUID External Lever Trim provides for access externally as required by use of key to lock and unlock the lever handle.

Euro Profile Half Cylinder is required (not supplied).

Available in SILVER only. (Black & White finishes available on request)



FLUID Series Exit Device Ordering Procedure

Sample part number FE-1-09/0-H-SIL is made up of six sections.
Choose your product by selecting an option from each section.

Products	Points	Length	Type	Latch	Finish
FE	1	09	0	H	SIL

Product	Length	Latch	Finish
FLUID Exit	900mm	Horizontal Latch	Silver
	1200mm	Vertical Latch	White
		Mortice Lock	Black
		Electric Mortice Lock	

Points	Type
Single Point	Standard
Double Point	Cyl Dogging
Triple Point	

* When ordering FLUID Exit Device product utilising Euro profile half (fixed cam) cylinders, please note that these are sold separately. Refer Lockwood keying section.

* All Lockwood FLUID Exit product is available ex-stock in Silver. White and Black finishes are available with lead times, please speak to your local ASSA ABLOY representative.

* Please specify and order FE5000*** External Lever Trims separately to the FLUID Exit Device.

* Mortice Lock version is not available in White

Refer to door configuration guide for more information.

9000 Series Access Control Panic Exit Device

Applications

Emergency exit doors in establishments open to the public which are locked electrically (hospitals, retirement homes, museums, educational establishments, supermarkets and retail stores).

Emergency exit doors in banks, administration buildings and industrial sites.

Isolated doors or doors functioning autonomously with 'break glass' box and connected to the buildings fire detection system.

Keying

Restricted Special Keying

Lockwood locks can be keyed to a number of controlled and/or specially keyed systems. These range from legally protected keys to protect against unauthorised duplication, which can also include specially designed key systems such as master key systems, which allow for different levels of mechanical access control.

Special Keying

Can be keyed alike, master keyed and grand master keyed in Lockwood high security, V7 and Status 6 keying systems.

Product Details

Door Thickness	Standard 35 to 45mm doors. Mortice lock version 32 to 48mm doors. Specify door thickness when other than standard.
Finish	Silver Polyester Powdercoat with red touch bar
Voltage	The power supply must be regulated rectified DC voltage. 24Vdc +/- 10%, 145mA

Standards and Compliance



Fire Rated

S2

(Security) Australian Lock Standard (AS4145.2.1993)

D3

(Durability) Australian Lock Standard (AS4145.2.1993)



Anti-Corrosion



Electromagnetic compatibility to European CE compliance, the equivalent of C-Tick compliance.

Conforms to Australian Standard BCA D2 -21 (d) for Egress Doors.

9000 Series Access Control Panic Exit Device

Door Control System

Designed to be integrated with building safety and control systems.

Electronic Security

Blocking Function (failsafe)

Ensuring exit control by electromechanical locking of the push bar, a solenoid locks the push bar, push bar unlocks on interruption of power supply and reverts to mechanical panic bar ensuring immediate exit.



Dogging Function (hold-back delayed)

Ensures access control through motorisation of the push bar retracts the bolt for free access for a number of seconds then resets the push bar in blocked position for selective entrance control.

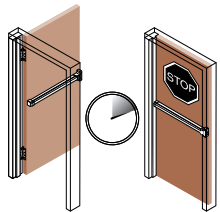

Dogging Function (hold-back timed)

Ensures access control through motorisation of the push bar and retraction of bolts for permanent free access (e.g. during opening times) or for a defined length of time for selective entrance control.

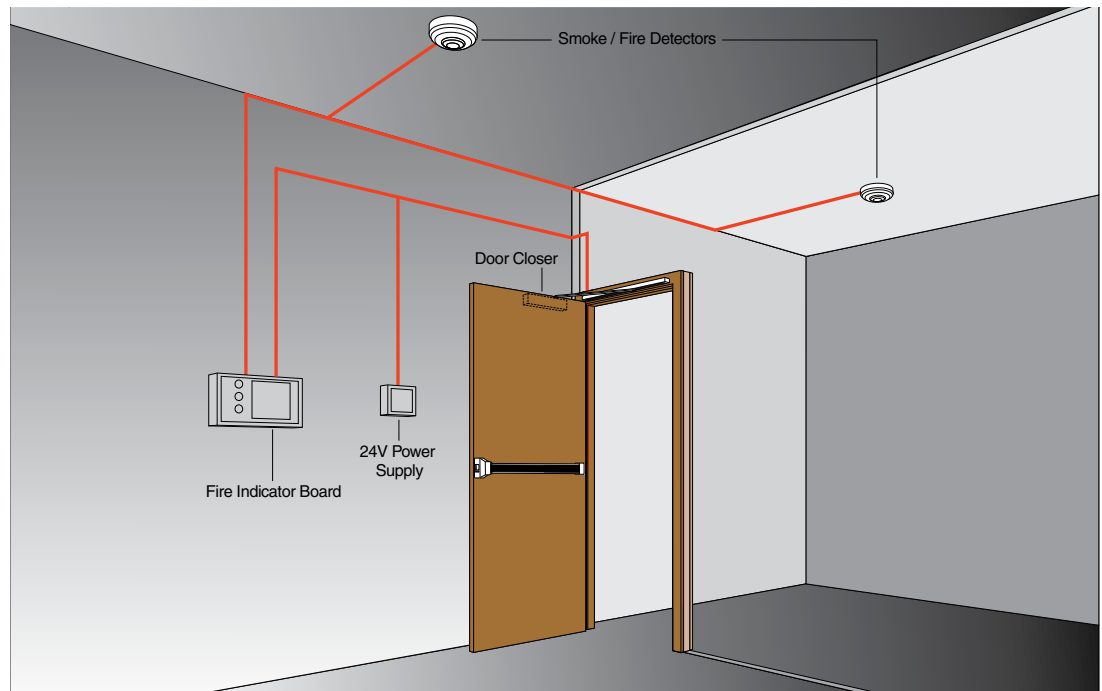
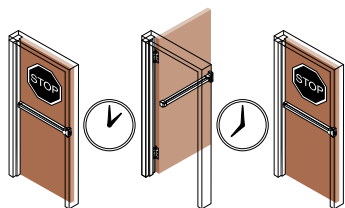

Monitoring

The dogging versions of the exit bars are equipped with a sensor in the door to provide monitoring on the status of the door opening and closing.

Central Control

Installation through a central control station enabling total control of vulnerable exit doors is possible, enabling video viewing of all doors, request to exit can be authorised or denied following usual checks at the control centre whilst the building is occupied.

9000/9100 Series Electromechanical Rim Type Panic Exit Device



Description

The Lockwood 9000/9100 Electromechanical Rim Type Panic Exit Device is designed for locking of emergency exits in accordance with BCA Standards D2 -21 (d) for Egress, Fire and Safety Regulations for Public Buildings. Provides a ready means of escape at all times by the single action of pushing on a horizontal bar fitted across the full width of a door.

Features and Specifications

- Suitable for single and double door applications of 900 or 1200mm width doors.
- 9000/9100 adjustable on site.
- 9700 factory made to order.
- The basic 9000 Series Horizontal Panic Exit Device is suitable for timber, metal and security glass doors with mid rail.
- All functions are reversible and non-handed.
- Deadlatching on all bolts.

Product Details

Door Width	900mm or 1200mm
Finish	Silver Polyester Powdercoat with red touch bar
Handing	Non Handed

Standards and Compliance



Fire Rated.

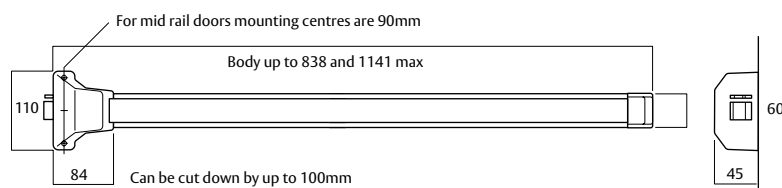

Pack includes double door strike.

9000/9100 Series Electromechanical Rim Type Panic Exit Device

Horizontal Push Bar

Part Number	Description
-------------	-------------

9000EO/24BSIL	Single point locking, 900mm door 24V
---------------	--------------------------------------

9100EO/24BSIL	Single point locking, 1200mm door 24V
---------------	---------------------------------------

Description

Blocking Version (adjustable on site)

Optional 201-252SC Cylinder for Key Entry (order separately)

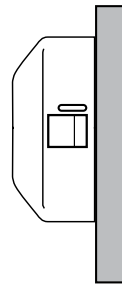

Standards and Compliance



Fire Rated

Horizontal Push Bar

Part Number	Description
-------------	-------------

9700EO/24BDMSIL	Single point locking, 24V
-----------------	---------------------------

Description

Blocking Dodging Monitoring Version

Door width to be nominated (not approved fire doors)

Optional 201-252SC Cylinder for Key Entry (order separately)

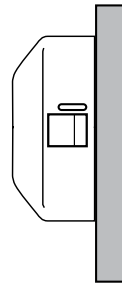

Outside Lever Trim Plates



9000/10SIL Lever Plate
Safety clutch in outside lever trim plate protects the unit from damage that could otherwise render the device inoperable.

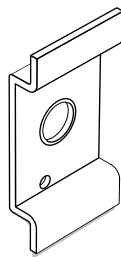

**9000/15SIL
Cylinder Pull Plate**

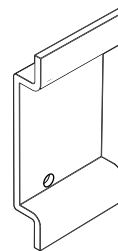

**9000/20SIL
Plain Pull Plate**

9300/9400 Series Electromechanical Vertical Type Panic Exit Device



Description

The Lockwood 9300/9400 Electromechanical Vertical Type Panic Exit Device is designed for locking of emergency exits in accordance with BCA Standards D2 -21 (d) for Egress, Fire and Safety Regulations for Public Buildings. Provides a ready means of escape at all times by the single action of pushing on a horizontal bar fitted across the full width of a door.

Features and Specifications

- Suitable for single and double door applications of 900 or 1200mm width doors.
- 9300/9400 adjustable on site.
- 9800 factory made to order.

Door Height

Standard maximum height up to 2300mm extension to 3000mm.

Installed with centre line of exit device at 1023mm above finished floor level.

The basic 9000 Series Horizontal Panic Exit Device is suitable for timber, metal and security glass doors with mid rail.

All functions are reversible and non-handed.

Deadlatching on all bolts.

Product Details

Door Height	2300mm (standard) 3000mm (with extension)
Door Stile	Suitable for both 90° and flush head door stiles minimum head clearance requirement of 30mm.
Door Width	900mm or 1200mm
Finish	Silver Polyester Powdercoat with red touch bar.
Handing	Reversible and Non Handed.
Latches	Top - automatic Bottom - automatic, pick resistant

Standards and Compliance



Fire Rated.

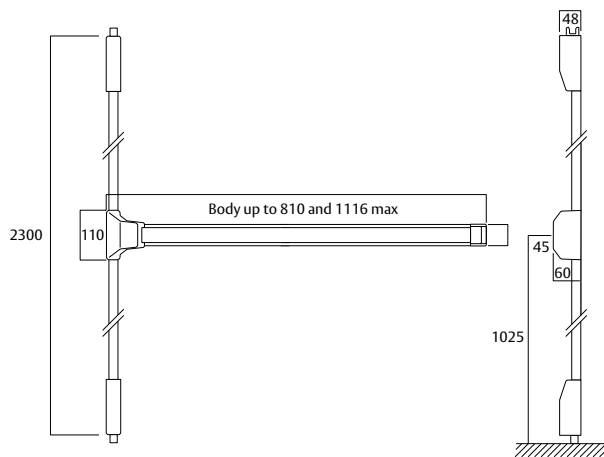

Pack includes standard and flush head top strike.

9300/9400 Series Electromechanical Vertical Type Panic Exit Device

Vertical Push Bar

Part Number	Description
9300EO/24BSIL	2 point locking, 900mm door 24V
9400EO/24BSIL	2 point locking, 1200mm door 24V

Blocking Function (failsafe)

Ensuring exit control by electromechanical locking of the push bar, a solenoid locks the push bar, push bar unlocks on interruption of power supply and reverts to mechanical panic bar ensuring immediate exit.

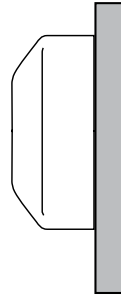

Standards and Compliance



Fire Rated

Description

Vertical Blocking Version (adjustable on site)

Optional 8219-303SC Cylinder for Key Entry (order separately)

Vertical Push Bar

Part Number	Description
9800EO/24BDMSIL	2 point locking, 24V

Dogging Function (hold-back delayed)

Ensures access control through motorisation of the push bar, retracts the bolt for free access for a number of seconds then resets the push bar in blocked position for selective entrance control.

Dogging Function (hold-back timed)

Ensures access control through motorisation of the push bar and retraction of bolts for permanent free access (e.g. during opening times) or for a defined length of time for selective entrance control.

Monitoring

The dogging versions of the exit bars are equipped with a sensor in the door to provide monitoring on the status of the door opening and closing.

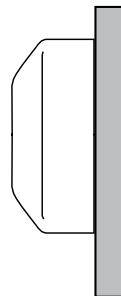

Description

Vertical Blocking Dogging Monitoring Version (not approved for fire doors)

Optional 201-252SC Cylinder for Key Entry (order separately)

9300/9400 Series Electromechanical Vertical Type Panic Exit Device

9900 Monitored Dummy Push Bars

Part Number	Description
9900MDPSIL	Monitored Dummy Push Bar to suit 900mm doors
9950MDPSIL	Monitored Dummy Push Bar to suit 1050mm doors

Outside Lever Trim Plates



9000/10SIL Lever Plate
Safety clutch in outside lever trim plate protects the unit from damage that could otherwise render the device inoperable.

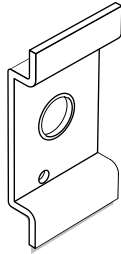



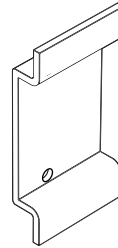



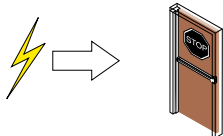
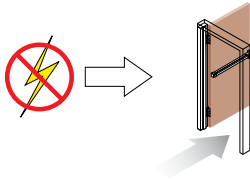

9000/15SIL
Cylinder Pull Plate

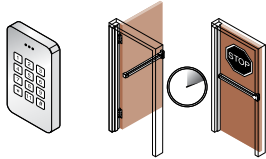

9000/20SIL
Plain Pull Plate

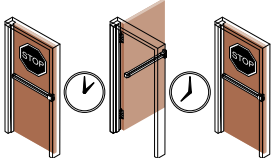
Panic Exit Devices

Function	Description	Suggested Options
<p>Blocking (Fail Safe)</p> <p> Fire Rated In accordance with Australian Standard.</p>	<p>Power "ON" locks push bar no exit</p>  <p>Power "OFF" unlocks push bar for exit</p> 	<p>Fire Detector </p> <p>Break Glass </p> <p>Digital Keypad </p>
<p>Dogging (Hold-back delayed)</p> <p>Not approved for fire doors</p>	<p>Bolt retracts, permitting free access for a number of seconds then resets the push bar in blocked position</p>  <p>Includes door monitoring</p>	<p>Digital Keypad </p> <p>Card Reader </p>
<p>Dogging (Hold-back timed)</p> <p>Not approved for fire doors</p>	<p>Bolt retracts, permitting permanent free access (e.g. during opening times) or for a defined length of time.</p>  <p>Includes door monitoring</p>	<p>Digital Keypad </p> <p>Card Reader </p>





ASSA ABLOY

Lockwood is the leading brand in the Australian locking industry. With an established reputation for high quality products, this iconic brand provides a wide range of locking solutions to residential housing, commercial building and industrial application markets. Lockwood is supported by an extensive distribution and after-sales support network. Our customers include retailers, architects, trade and industrial personnel, locksmiths and security dealers.

ASSA ABLOY is the global leader in door opening solutions, dedicated to satisfying end-user needs for security, safety and convenience.

ASSA ABLOY is represented in all major regions, in both mature and emerging markets, with leading positions in Australia, Europe and North America.

**25YEAR
MECHANICAL
WARRANTY**

The Lockwood 25 Year Mechanical Warranty

Our belief that we manufacture the finest premium products available in today's market place is backed by the Lockwood 25 Year Mechanical Warranty, ensuring that Lockwood continues to keep Australians safe by delivering security and peace of mind.

For warranty terms and conditions, please visit www.lockweb.com.au or call **1300WARRANTY**

ASSA ABLOY Australia Pty Ltd
235 Huntingdale Road
Oakleigh, Victoria, 3166
Australia

1300 LOCK UP (1300 562 587)
lockweb.com.au

ASSA ABLOY New Zealand Ltd
6 Armstrong Road
Albany, Auckland, 0632
New Zealand

info.nz@assaabloy.com
Telephone +64 9415 7111
assaabloy.co.nz

Disclaimer

Whilst every effort has been made to ensure that the information contained in this brochure is accurate at the time of publication, ASSA ABLOY Australia Pty Limited ("ASSA ABLOY") recommends that you consult ASSA ABLOY or its agents prior to placing an order to ascertain current information on specific products, as ASSA ABLOY reserves the right to make any changes without notice. ASSA ABLOY will not be liable for any injury, loss or damage whatsoever, arising from any errors or omissions in the information contained in the brochure or arising from the use or application of the information contained herein.

