



INSTALLER REFERENCE GUIDE

Rev 1.2



CM430S RS485 LAN To Ethernet Converter Module



CM430S - RS485 LAN TO ETHERNET CONVERTER MODULE

The CM430S allows you to extend the control panels RS485 LAN across a local network. Table 1: shows the panel and panel firmware which are compatible with the CM430S converter module. MENU 7-7-0, Option 5 (Extend LAN Fail) must be set when using the CM430S.

CM430S Compatibility	
Panels Supported	Version
Solution 6000	V2.29 or higher

Table 1: CM430S Compatibility



MENU 7-7-0, Option 5 (Extend LAN Fail) must be set when using the CM430S.

LED Status

The following LED indicators are provided on the CM430S module.

LED	Colour	Activity	Description
Active	Green / Blue	Blue	Data sent from Ethernet to Serial
		Green	Data sent from Serial to Ethernet
LINK	Green/Blue	Blue	Connection Established
		Green	Ethernet Cable connected
Power	RED	Off	Power OFF
		On	Power ON

Table 2: LED Indicators

Initial Setup

Using a stand alone computer (your PC must have an Ethernet port), you can connect your computer directly to the CM430S using a crossover Ethernet cable. Otherwise, connect both the computer and CM430S using straight-through Ethernet cable to a hub or switch.

(Ensure computers adapter is set to the same base address, ie: 192.168.1.1 See page 7 - Windows IP Configuration)

Quick Setup With Fixed IP

The CM430S has the following default settings.

Option	Default Setting
IP Address (Factory)	192.168.1.200
IP Address (Default Switch)	192.168.1.254
Subnet Mask	255.255.255.0
Gateway	192.168.1.1
Primary DNS	192.168.1.3
Connection Mode	TCP Server
Connection Port Number	5000
Remote Host IP Address	0.0.0.0

Table 3: Quick Setup With Fixed IP

CM430S Configuration (Point to Point)

Connect a module to your computer and power the module using 12VDC.

Open your browser and enter 192.168.1.200 (Factory set) and press [Enter].

If the unit is reset by the user, then its default address will be 192.168.1.254

A window will be displayed prompting you to enter the password (default = 123456).

After entering the password, the web browser page will be displayed.



Please do not modify **ADVANCED SETTINGS** from default values.



CM430S - LAN to Ethernet Interface

Logout

Device Information

Device Name	Location 1	Firmware Version	V1. 555	Device MAC	XX-XX-XX-XX-XX-XX
-------------	------------	------------------	---------	------------	-------------------

Network Settings

Device IP	192. 168. 1. 5	Device Port	4196	Device WEB Port	80
Work Mode	TCP Server	Subnet Mask	255. 255. 255. 0	Gateway	192. 168. 1. 5
Destination IP/DNS	192. 168. 1. 5	Destination Port	4196	IP Mode	Static

Advanced Settings

N0-Data-Restart	Disable	No Data Restart Time	300 5~1270 second	Reconnect-time	12 1~255 second
-----------------	---------	----------------------	-------------------	----------------	-----------------

Modify Web Login Key

New Key	<input type="text"/>	Input Key Again	<input type="text"/>	<input type="text"/>	<input type="text"/>
---------	----------------------	-----------------	----------------------	----------------------	----------------------

Submit

Figure 1: Point to Point - Location 1



CM430S - LAN to Ethernet Interface

Logout

Device Information

Device Name	Location 2	Firmware Version	V1. 555	Device MAC	XX-XX-XX-XX-XX-XX
-------------	------------	------------------	---------	------------	-------------------

Network Settings

Device IP	192. 168. 1. 6	Device Port	4196	Device WEB Port	80
Work Mode	TCP Client	Subnet Mask	255. 255. 255. 0	Gateway	192. 168. 1. 5
Destination IP/DNS	192. 168. 1. 5	Destination Port	4196	IP Mode	Static

Advanced Settings

N0-Data-Restart	Disable	No Data Restart Time	300 5~1270 second	Reconnect-time	12 1~255 second
-----------------	---------	----------------------	-------------------	----------------	-----------------

Modify Web Login Key

New Key	<input type="text"/>	Input Key Again	<input type="text"/>	<input type="text"/>	<input type="text"/>
---------	----------------------	-----------------	----------------------	----------------------	----------------------

Submit

Figure 2: Point to Point - Location 2

The CM430S module at the panel (Location 1) has to be set to 'TCP Server', and the CM430S module at the destination (Location 2) is to be set as 'TCP Client'.

The table below is an example of configuring the Client and Server modules.

Option	Location 1 SERVER	Location 2 CLIENT
Device IP	192.168.1.5	192.168.1.6
Subnet Mask	255.255.255.0	255.255.255.0
Gateway	192.168.1.5	192.168.1.5
Primary DNS	168.95.1.1	168.95.1.1
Work Mode	TCP SERVER	TCP CLIENT
Destination Port	4196	4196
Destination IP/DNS	192.168.1.5	192.168.1.5
IP Mode	Static	Static

Table 4: Example Point to Point Configuration

After all settings have been complete, click 'Apply' and the changes will take effect. Note: It is best to power cycle the module after any changes.

Connection Diagram - Point to Point Configuration

A pair of CM430S modules is required for each link as shown below. Remote locations will require a local power supply with backup battery to maintain connectivity during power outages. A CM720 1 amp or CM723 5 amp power supply module would be suitable for this task.

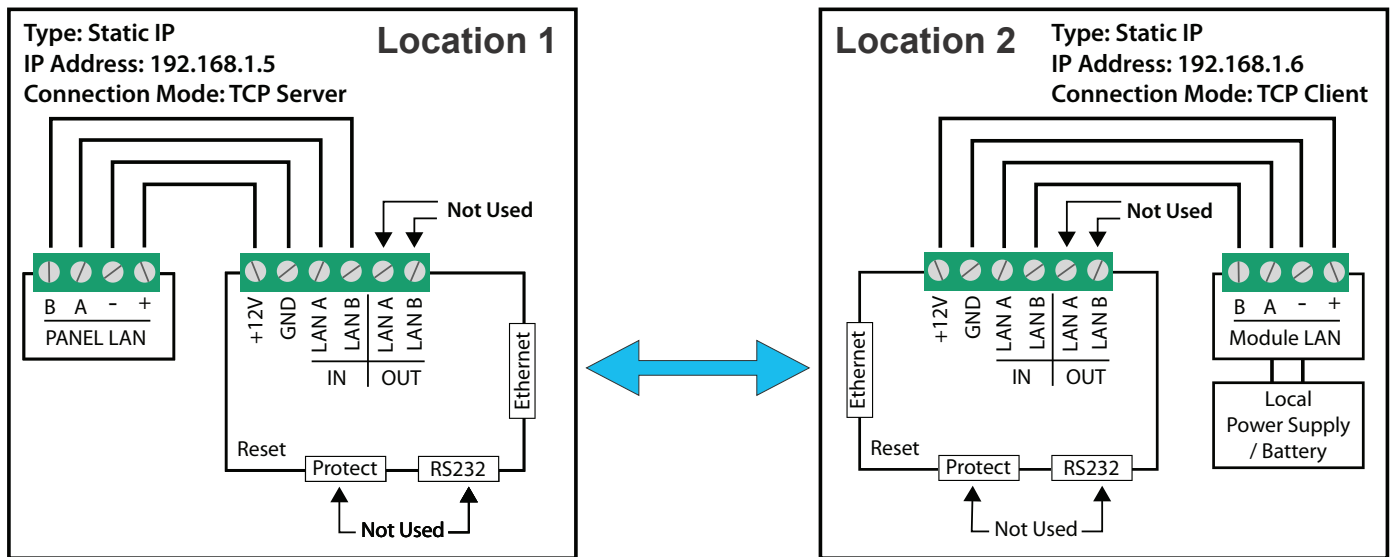

Figure 3: Sample Point to Point Wiring



LAN A OUT, LAN B OUT and the Protect Switch are for Future Use

CM430S Star Configuration

An array of 17 x CM430S modules (1xServer, 16x Clients) can be used if more than one location is needed. This configuration will need to go through a LAN switch that has a backup power supply. Each Remote location will require a local power supply with backup battery to maintain connectivity during power outages.

A CM720, 1 amp or CM723, 5 amp power supply module would be suitable for this task.



CM430S - LAN to Ethernet Interface

Device Information

Device Name	<input type="text" value="Location 1"/>	Firmware Version	V1. 555	Device MAC	XX-XX-XX-XX-XX-XX
-------------	---	------------------	---------	------------	-------------------

Network Settings

Device IP	<input type="text" value="192. 168. 1. 5"/>	Device Port	<input type="text" value="4196"/>	Device WEB Port	<input type="text" value="80"/>
Work Mode	<input type="text" value="TCP Server"/>	Subnet Mask	<input type="text" value="255. 255. 255. 0"/>	Gateway	<input type="text" value="192. 168. 1. 5"/>
Destination IP/DNS	<input type="text" value="192. 168. 1. 5"/>	Destination Port	<input type="text" value="4196"/>	IP Mode	<input type="text" value="Static"/>

Advanced Settings

N0-Data-Restart	<input type="text" value="Disable"/>	No Data Restart Time	<input type="text" value="300"/> 5~1270 second	Reconnect-time	<input type="text" value="12"/> 1~255 second
-----------------	--------------------------------------	----------------------	--	----------------	--

Modify Web Login Key

New Key	<input type="text"/>	Input Key Again	<input type="text"/>	<input type="text"/>	<input type="text"/>
---------	----------------------	-----------------	----------------------	----------------------	----------------------

Figure 4: Sample Star Configuration - Location 1



CM430S - LAN to Ethernet Interface

Device Information

Device Name	<input type="text" value="Location 2...17"/>	Firmware Version	V1. 555	Device MAC	XX-XX-XX-XX-XX-XX
-------------	--	------------------	---------	------------	-------------------

Network Settings

Device IP	<input type="text" value="192. 168. 1. (6..21)"/>	Device Port	<input type="text" value="4196"/>	Device WEB Port	<input type="text" value="80"/>
Work Mode	<input type="text" value="TCP Client"/>	Subnet Mask	<input type="text" value="255. 255. 255. 0"/>	Gateway	<input type="text" value="192. 168. 1. 5"/>
Destination IP/DNS	<input type="text" value="192. 168. 1. 5"/>	Destination Port	<input type="text" value="4196"/>	IP Mode	<input type="text" value="Static"/>

Advanced Settings

N0-Data-Restart	<input type="text" value="Disable"/>	No Data Restart Time	<input type="text" value="300"/> 5~1270 second	Reconnect-time	<input type="text" value="12"/> 1~255 second
-----------------	--------------------------------------	----------------------	--	----------------	--

Modify Web Login Key

New Key	<input type="text"/>	Input Key Again	<input type="text"/>	<input type="text"/>	<input type="text"/>
---------	----------------------	-----------------	----------------------	----------------------	----------------------

Figure 5: Sample Star Configuration - Locations 2...17

Option	Location 1 SERVER	Location 2 CLIENT	Location 3 CLIENT	Location 4 CLIENT
Device IP	192.168.1.5	192.168.1.6	192.168.1.7	192.168.1.8
Subnet Mask	255.255.255.0	255.255.255.0	255.255.255.0	255.255.255.0
Gateway	192.168.1.5	192.168.1.5	192.168.1.5	192.168.1.5
Primary DNS	168.95.1.1	168.95.1.1	168.95.1.1	168.95.1.1
Work Mode	TCP Server	TCP Client	TCP Client	TCP Client
Destination Port	4196	4196	4196	4196
Destination IP/DNS	192.168.1.5	192.168.1.5	192.168.1.5	192.168.1.5
IP Mode	Static	Static	Static	Static

Table 5: Star Configuration Example Settings

Connection Diagram - Star Configuration

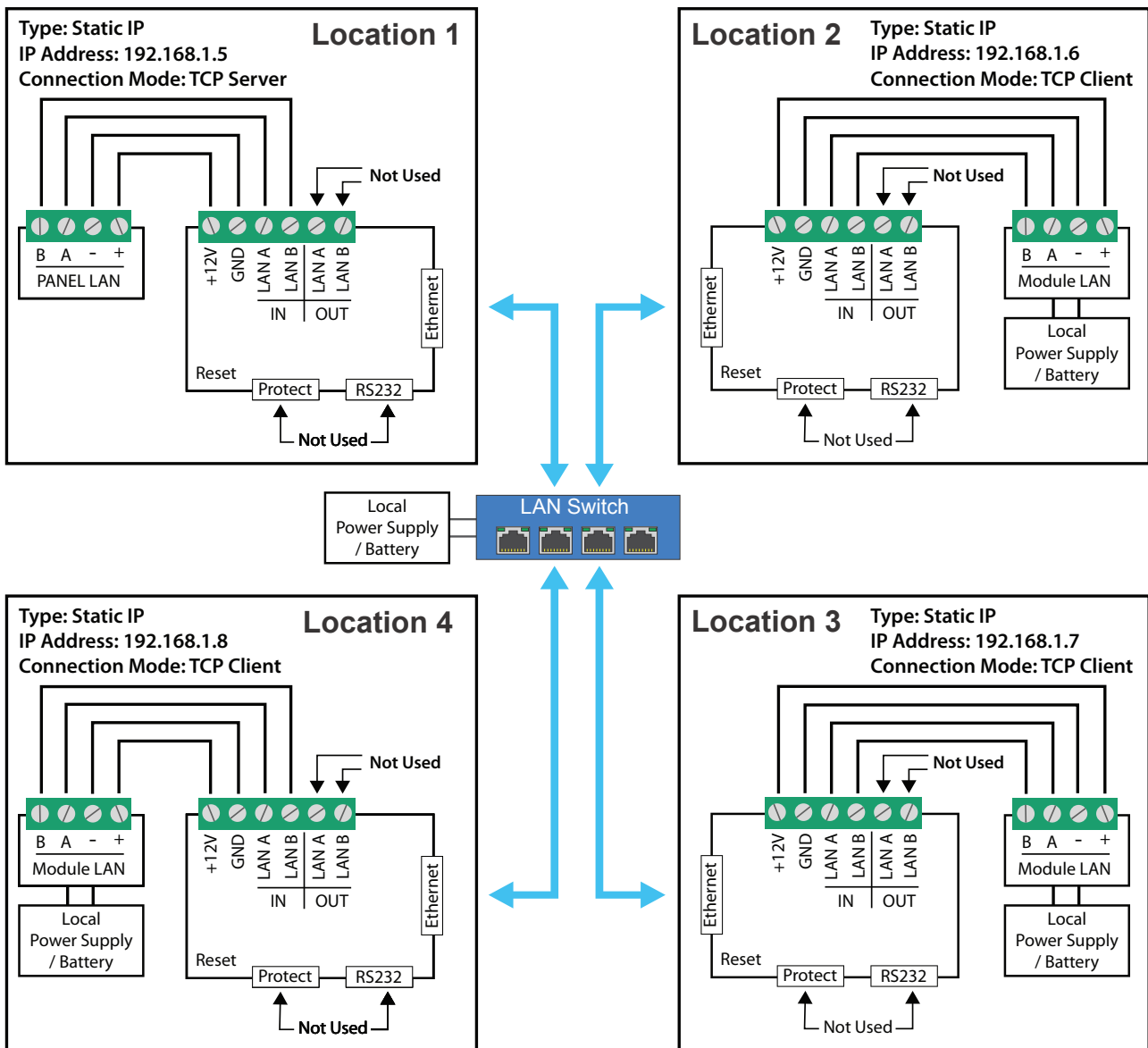

Figure 6: Sample Star Configuration Wiring



LAN A OUT, LAN B OUT and the Protect Switch are for Future Use

Windows IP Configuration

Click on Start button and choose Settings.

1. Choose Network & Internet.
2. Click on Ethernet -> Change adapter options. ...
3. Click Internet Protocol Version 4 (TCP/IPv4), and then click Properties. ...

Warning:

Before changing any of the numbers, ensure you take note of the original settings, as this will disconnect you from your normal network connection. Digiflex does not take any responsibility for your PC configuration, if you are not experienced in networking, please contact your IT person.

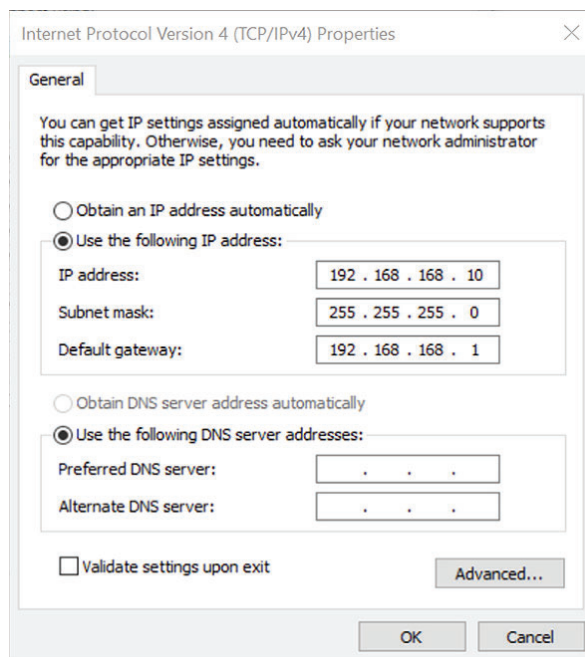

Figure 7: Windows PC IP Config Setup Page

CM430S Reset

The CM430S modules can be reset whilst powered up by using a thin screwdriver and sliding the Reset switch from OFF to ON position, then after 2-3 seconds, back to the OFF position. This will reset the device IP to **192.168.1.254**

CM430S Specifications

Part Number:	CM430S - RS485 LAN To Ethernet Module - Supporting Star Configuration
Operating Voltage:	10.5V D.C - 14.5V D.C. @ 150mA Max
Module Connection:	Ethernet Interface: 10 / 100Base-T, Half / Full Duplex
(RS485 LAN)	RS485 Signal: 2 wire Data+/-
Operating Environment:	0° to 55°C RH 5 to 80% at 30°C non-condensing.
Certification:	EN55032:2012, EN55024: 2010.A1:2015, EN61000-3-2:2014, EN61000-2-2:2013
Warranty:	3 years from date of manufacture (return to base).

In the interest of ongoing product development this document is subject to change without notice.





DIGIFLEX PTY LTD

Unit 5, 8 Millennium Court
Silverwater NSW 2128
AUSTRALIA

Phone: (+612) 97417000
Facsimile: (+612) 97417042
www.digiflex.com.au

Our Vision Is Your Peace Of Mind