

PRIMO

TECHNICAL INFORMATION 24/7 SECURITY MONITOR PRIMO24

V1.2 JUL 2023

FEATURES:

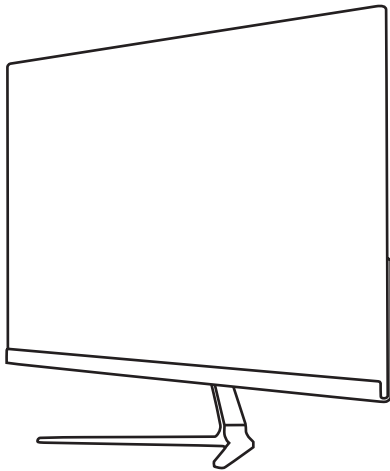

1. 24" diagonal display with low energy consumption, zero radiation, high image stability
2. 1920 x 1080 Full HD resolution, 16:9 aspect ratio, 4K@30Hz compatible
3. Designed for 24/7 operation - ideal for Security Monitoring
4. High brightness TFT LED screen
5. Wide horizontal and vertical viewing angles for easy indirect viewing
6. Thin body, only 8 mm
7. 8 bit image processing technology providing high pixel line by line scanning and realistic picture quality
8. Intelligent 3D noise reduction, residual shadow elimination
9. Dynamic brightness and contrast, with color optimization technology for flexible image display
10. 6.5 ms fast response time to avoid image blur on movement
11. Low blue light output- reduces eyestrain
12. Low 25 watt power consumption
13. Two year exchange warranty

APPLICATION

Specifically designed for use as a Surveillance Monitor, operating 24 hours a day, 7 days a week, due to its cool running external in line power supply.

Its thin bezel makes it ideal for stacking in multi monitor setups in control rooms.

Ideal for use in other display applications where continuous operation and high performance is required.

TECHNICAL PARAMETERS

Screen size: 23.8"
Screen type: LED TFT
Aspect ratio: 16:9
Brightness: 250 nit
Contrast ratio: 3000 : 1
Response time: 6.5 ms
Colour depth: 8 bit
Visual angle: 178° / 178°
Display colour range: 16.7M
Resolution: FHD 1920 x 1080 pixels (4K@30Hz compatible)
Input port: HDMI, VGA
Audio output: Stereo speaker, audio jack (3.5mm)
Power supply: 12v DC / 25W
Shell material: Flame retardant plastic & metal
Display screen dimensions: 544 x 320 x 38 mm (without base)
Mounting: Base (included), VESA (75 mm x 75 mm)
Included: 1.5M HDMI cable, DC power supply
Weight: 2.7 kg
Operating environment:
0°C to +50°C (20% to 80% RH - Non Condensing)
Storage environment:
-20°C to 60°C (5% to 90% RH - Non Condensing)

specifications are subject to change without notice

PRODUCT DIMENSIONS

2 YEAR WARRANTY

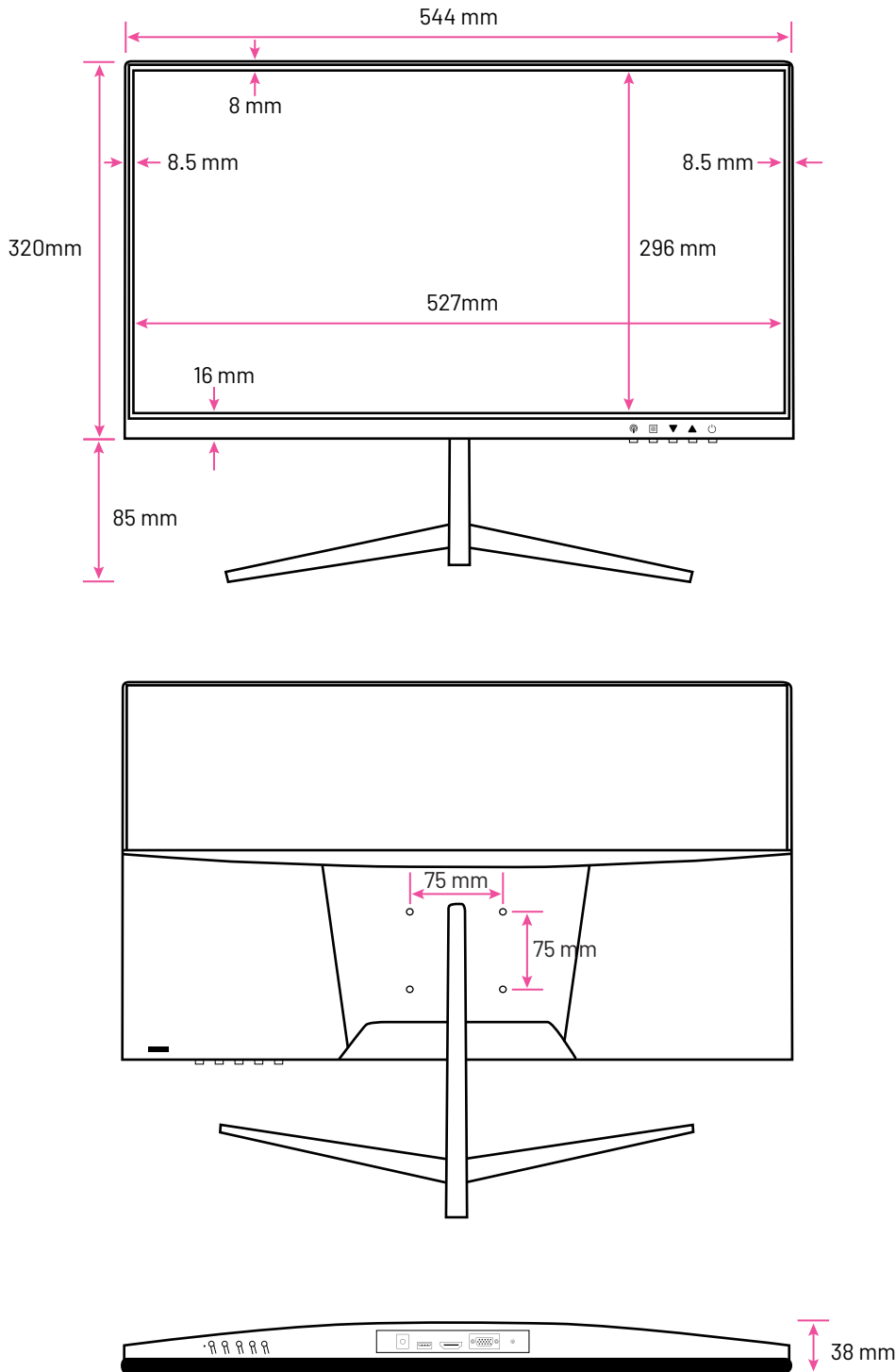

specifications are subject to change without notice