

# DH-IPC-HDW2549EMP-S-PRO-ANZ

## 5MP WizColor Fixed-focal Eyeball WizSense Network Camera



**WizSense**

Launched by Dahua Technology, WizSense is a series of AI products and solutions that adopt independent AI chip and deep learning algorithm. It focuses on human and vehicle with high accuracy, enabling users to fast act on defined targets. Based on Dahua's advanced technologies, WizSense provides intelligent, simple and inclusive products and solutions.

### Series Overview

With advanced deep learning algorithm, Dahua WizSense 2 Series network camera supports intelligent functions, such as perimeter protection and smart motion detection. With starlight technology, this series camera provides a better image effect in the condition of low illuminance.

### Functions

#### WizColor Technology

Dahua WizColor Technology seamlessly combines with the powerful AI-ISP, large pixel size sensor and large aperture in cameras. This unique integration enables cameras to effortlessly capture high-quality images with vibrant colors during nighttime scenarios, ensuring fine details are preserved and minimizing motion blur. Unlike traditional self-illuminating cameras, Dahua WizColor Technology maximizes the utilization of weak light sources, such as moonlight and city lights reflected in the sky, delivering captivating full-color images of the entire scene. It also ensures that monitoring distances are not compromised at night due to limited illumination ranges, facilitating full-color image capture even over long distances.

#### AI-ISP

With AI ISP technology, the camera is able to easily adapt to scenes, producing high quality images that reveal the fine details of targets.

#### SMD Plus

With intelligent algorithm, Dahua Smart Motion Detection technology can categorize the targets that trigger motion detection and filter the motion detection alarm triggered by non-concerned targets to realize effective and accurate alarm.

#### Perimeter Protection

With deep learning algorithm, Dahua Perimeter Protection technology can recognize human and vehicle accurately. In restricted area (such as pedestrian area and vehicle area), the false alarms of intelligent detection based on target type (such as tripwire, intrusion, fast moving, parking detection, loitering detection and gathering detection) are largely reduced.

- 1/1.8" CMOS image sensor, low luminance, and high definition image.
- Outputs max. 5 MP (2960 × 1668) @20 fps, and supports (2688 × 1520) @25/30 fps.
- H.265 codec, high compression rate, ultra-low bit rate.
- Built-in warm light, and the max. illumination distance is 30 m.
- ROI, SMART H.264+/H.265+, flexible coding, applicable to various bandwidth and storage environments.
- Rotation mode, WDR, 3D NR, HLC, BLC, digital watermarking, applicable to various monitoring scenes.
- Intelligent monitoring: Intrusion, tripwire (the two functions support the classification and accurate detection of vehicle and human).
- Abnormality detection: Motion detection, video tampering, audio detection, no SD card, SD card full, SD card error, network disconnection, IP conflict, illegal access, and voltage detection.
- Supports max. 256 G Micro SD card; built in Mic.
- 12 VDC/PoE power supply, easy for installation.
- IP67 protection.
- SMD Plus



#### Smart H.265+ & Smart H.264+

With advanced scene-adaptive rate control algorithm, Dahua smart encoding technology realizes the higher encoding efficiency than H.265 and H.264, provides high-quality video, and reduces the cost of storage and transmission.

#### Cyber Security

Dahua network cameras employ a series of security technologies, including security authentication and authorization, access control protocols, trusted protection, encrypted transmission and encrypted storage. These technologies improve the camera's defense against external cyber threats and prevent malicious programs from compromising the device.

#### Protection (IP67, Wide Voltage)

IP67: The camera passes a series of strict test on dust and soak. It has dust-proof function, and the enclosure can work normally after soaking in 1 m deep water for 30 minutes. Wide voltage: The camera allows ±30% (for some power supplies) input voltage tolerance (wide voltage range), and it is widely applied to outdoor environment with instable voltage.

## Technical Specification

### Camera

Image Sensor	1/1.8" CMOS
Max. Resolution	2960 (H) × 1668 (V)
ROM	128 MB
RAM	256 MB
Scanning System	Progressive
Electronic Shutter Speed	Auto/Manual 1/3 s–1/100,000 s
Min. Illumination	0.0005 lux@F1.0
S/N Ratio	>56 dB
Illumination Distance	Up to 30 m (98.43 ft) (Warm light)
Illuminator On/Off Control	Auto; Manual
Illuminator Number	2 (Warm light)
Angle Adjustment	Pan: 0°–360° Tilt: 0°–78° Rotation: 0°–360°

### Lens

Lens Type	Fixed-focal
Lens Mount	M16
Focal Length	2.8 mm
Max. Aperture	F1.0
Field of View	2.8 mm: H: 112°; V: 60°; D: 134°
Iris Control	Fixed
Close Focus Distance	2.8 mm: 1.7 m (5.58 ft)

	Lens	Detect	Observe	Recognize	Identify
	2.8 mm	57.9 m ( 189.96 ft)	23.2 m ( 76.12 ft)	11.6 m ( 38.06 ft)	5.8 m ( 19.03 ft)

**DORI Distance**

\*DORI (Detect, Observe, Recognize, Identify) is a standard system (EN-62676-4) for defining the ability of a person viewing the video to distinguish persons or objects within a covered area. The numbers in this table do not reflect intelligent function distances. For intelligent function distances, refer to installation and commissioning manual/project design tool.

### Intelligence

IVS (Perimeter Protection)	Intrusion, tripwire (the two functions support the classification and accurate detection of vehicle and human);
SMD	SMD Plus
Smart Search	Work together with Smart NVR to perform refine intelligent search, event extraction and merging to event videos

### Video

Video Compression	H.265; H.264; H.264H; H.264B; MJPEG (Only supported by the sub stream)
-------------------	--

Smart Codec	Smart H.265+; Smart H.264+
Video Frame Rate	Main stream: 2960 × 1668@(1–20 fps)/2688 × 1520@(1–25/30 fps) sub stream: 704 × 576@(1–25 fps)/704 × 480@(1–30 fps) *The values above are the max. frame rates of each stream; for multiple streams, the values will be subjected to the total encoding capacity.
Stream Capability	2 streams
Resolution	5M (2960 × 1668); 4M (2688 × 1520); 3M (2304 × 1296); 1080p (1920 × 1080); 1.3M (1280 × 960); 720p (1280 × 720); D1 (704 × 576/704 × 480); VGA (640 × 480); CIF (352 × 288/352 × 240)
Bit Rate Control	VBR; CBR
Video Bit Rate	H.264: 32 kbps–6144 kbps; H.265: 12 kbps–6144 kbps
Day/Night	Color/B/W
BLC	Yes
HLC	Yes
WDR	120 dB
White Balance	Auto; natural; street lamp; outdoor; manual; regional custom
Gain Control	Auto/Manual
Noise Reduction	3D NR
Motion Detection	OFF/ON (4 areas, rectangular)
Region of Interest (RoI)	Yes (4 areas)
Smart Illumination	Yes
Image Rotation	0°/90°/180°/270° (Support 90°/270° with 2688 × 1520 resolution and lower)
Mirror	Yes
Privacy Masking	4 areas
LDC	Yes

### Audio

Built-in MIC	Yes, built-in Mic
Audio Compression	G.711a; G.711Mu; PCM; G.726

### Alarm

Alarm Event	No SD card; SD card full; SD card error; network disconnection; IP conflict; illegal access; motion detection; video tampering; tripwire; intrusion; audio detection; voltage detection; SMD; security exception
-------------	--

### Network

Network Port	RJ-45 (10/100 Base-T)
SDK and API	Yes
Network Protocol	IPv4; IPv6; HTTP; TCP; UDP; ARP; RTP; RTSP; RTCP; RTMP; SMTP; FTP; SFTP; DHCP; DNS; DDNS; QoS; UPnP; NTP; Multicast; ICMP; IGMP; NFS; PPPoE; P2P; Bonjour; Auto Registration
Interoperability	ONVIF (Profile S & Profile G & Profile T); CGI
User/Host	20 (Total bandwidth: 48 M)

Storage	FTP; SFTP; Micro SD card (support max. 256 GB); NAS
Browser	IE; Chrome; Firefox
Management Software	Smart PSS Lite; DSS; DMSS
Mobile Client	iOS; Android
Cyber Security	Video encryption; Firmware encryption; Configuration encryption; Digest; WSSE; Account lockout; Security logs; IP/MAC filtering; Generation and importing of X.509 certification; syslog; HTTPS; 802.1x; Trusted boot; Trusted execution; Trusted upgrade; Session security; Security warning

### Certification

Certifications	CE-LVD: EN62368-1; CE-EMC: Electromagnetic Compatibility Directive 2014/30/EU;
----------------	---

### Power

Power Supply	12 VDC; PoE
Power Consumption	Basic: 2.0 W (12 VDC); 2.5 W (PoE); Max.: 5.3 W (12 VDC); 6.4 W (PoE) (H.265+ intelligence on + WDR + illuminator intensity)

### Environment

Operating Temperature	-40 °C to +60 °C (-40 °F to +140 °F)
Operating Humidity	≤95% (RH), non-condensing
Storage Temperature	-40 °C to +60 °C (-40 °F to +140 °F)
Storage Humidity	≤95% (RH), non-condensing
Protection	IP67

### Structure

Casing Material	Inner core: Metal; Cover: Plastic
Product Dimensions	109.5 mm × Φ109.9 mm (4.31" × Φ4.33")
Net Weight	0.42 kg (0.93 lb)
Gross Weight	0.59 kg (1.30 lb)

### Ordering Information

Type	Model	Description
IP CAMERA	DH-IPC-HDW2549EMP-S-PRO-ANZ	5MP WizColor Fixed-focal Eyeball WizSense Network Camera
	DH-PFA106	Mount Adapter
Accessories (Optional)	DH-PFB220C	Ceiling Mount Bracket
	DH-PFA139	Junction Box
	TF-P100	MicroSD Memory Card
	PFM900-E	Integrated Mount Tester
	DH-PFB204W	Wall Mount Bracket
	DH-PFA152-E	Pole Mount Bracket
	PFM321D	12 VDC 1 A Power Adapter

**Accessories**

Optional:



PFA139  
Junction  
Box



PFB204W  
Wall Mount  
Bracket



PFA106  
Mount  
Adapter



PFB220C  
Ceiling Mount  
Bracket



PFA152-E  
Pole Mount  
Bracket



PFM321D  
12 VDC 1 A  
Power Adapter



PFM900-E  
Integrated  
Mount Tester



TF-P100  
MicroSD Memory  
Card

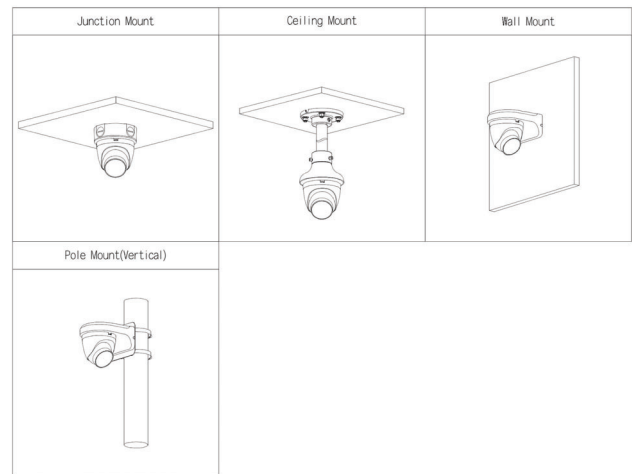

**Dimensions (mm[inch])**

