



Plasma / LCD TV Wall Bracket 23-55"



Max. VESA 400X500



20kg(44lbs) max.



23" - 55"(58-140cm)

CW-2864 User Manual

WARNING STATEMENTS

Warning

The wall structure must be capable of supporting at least a maximum weight of 20kg (44lbs) for 23"-55" televisions. If not, the wall must be reinforced. Proper installation procedure by a qualified service technician, as outlined in the installation instructions, must be adhered to. Failure to do so could result in serious personal injury, or even death.

Safety measures must be practiced at all times during the installation of this product. Use proper safety gear and tools for the installation procedure to prevent personal injury.

Prior to the installation of this product, the installation instructions should be read and completely understood. The installation instructions must be read to prevent personal injury and property damage. Keep these installation instructions in an easily accessible location for future reference.



A secure structure must support the weight or load of the display. When mounting to a wall that contains wooden studs, dead center of the wooden stud must be confirmed prior to installation.



Do not install on a structure that is prone to vibration, movement or chance of impact. Failure to do so could result in damage to the display and/or damage to the mounting surface.



Do not install near heater, fireplace, direct sunlight, air conditioning or any other source of direct heat energy. Failure to do so may result in damage to the display and could increase the risk of fire.



At least two qualified people should perform the installation procedure. Injury and/or damage can result from dropping or mishandling the display.



Recommended mounting surfaces: wooden studs and solid-flat concrete. If the mount is to be installed on any surface other than wooden studs, use suitable hardware (which is commercially available).

TOOLS REQUIRED NOT INCLUDED

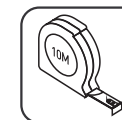
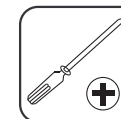

PARTS INCLUDED

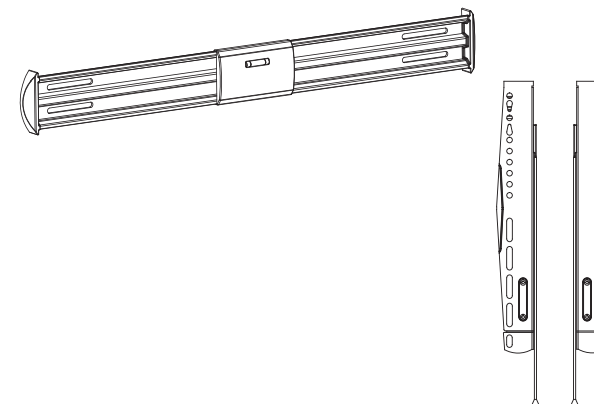

A	M4x12 (x4)	M4x30 (x4)
B	M5x12 (x4)	M5x30 (x4)
C	M6x12 (x4)	M6x30 (x4)
D	M8x16 (x4)	M8x30 (x4)
E	$\Phi 18 \times 6.5 \times 1.5$ (x4)	18X8X20(x4)
F	M6x60 (x6)	$\Phi 8 \times 40$ (x6)

▶ INSTALLATION

①

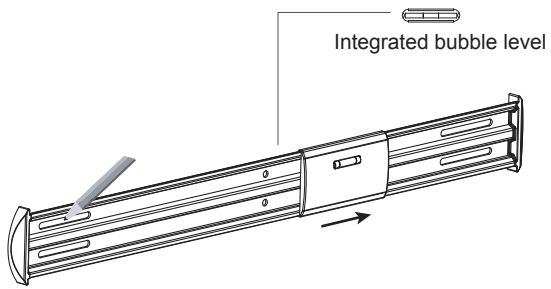

②

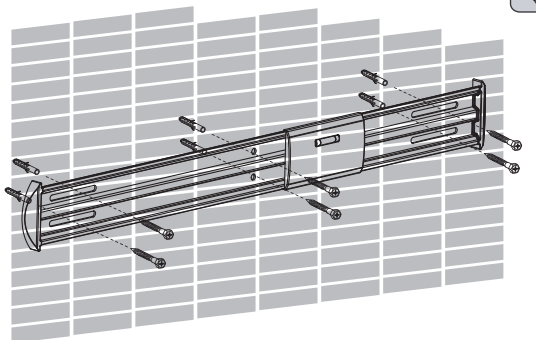
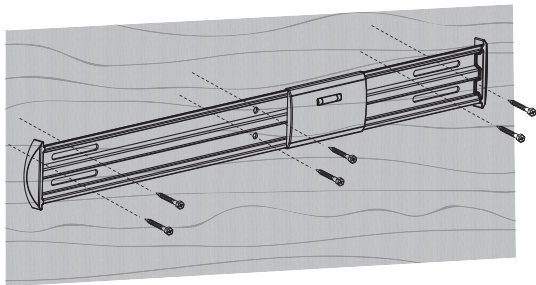
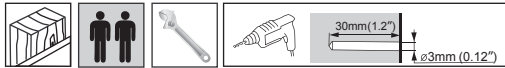

③

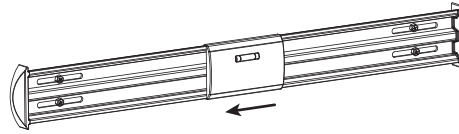

④

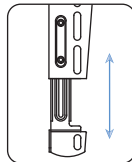
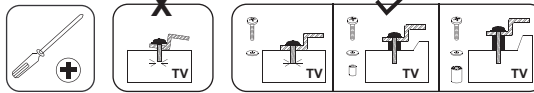

Extendable arms,
length up to 500mm

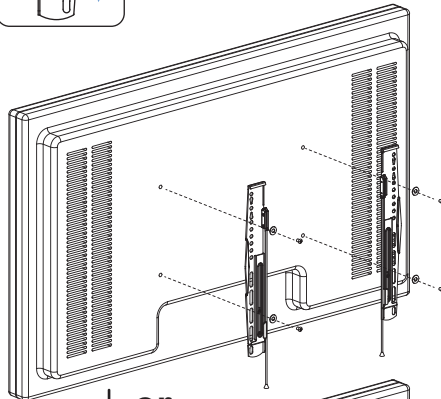

↓ or

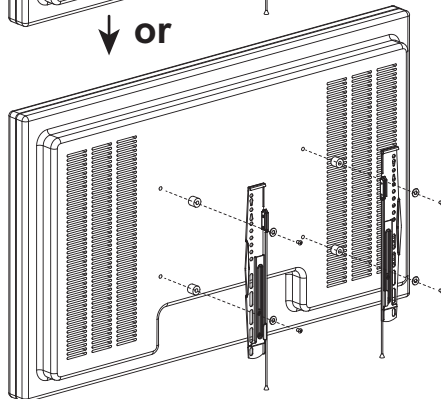

⑤

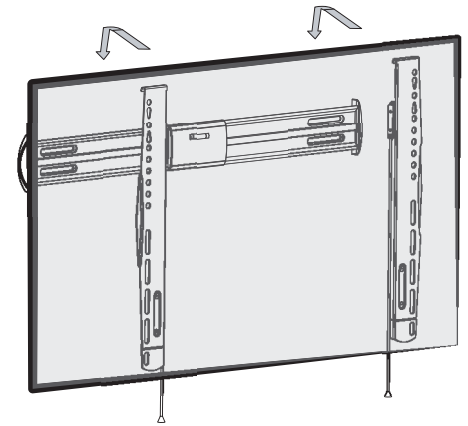

⑥

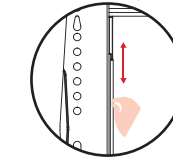
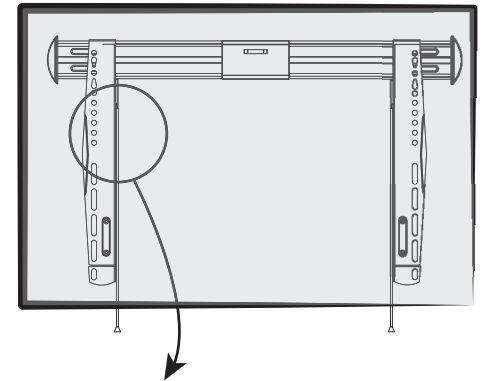

Lock/Unlock System



Distributed by:
TechBrands by Electus Distribution Pty.Ltd.
NSW 2116 Australia
Ph: 1300 738 555
Int'l: +61 2 8832 3200
Fax: 1300 738 500
www.techbrands.com