

GLR43308R

8-Channel 433MHz Gigalink™ Receiver with Relay Outputs

Features

- Supply voltage can be 12 – 24 Volts AC or DC
- Highly sensitive receiver input stage. When used with GLT433... transmitters an operating range of 350 metres (980 ft) is possible.
- Eight relay outputs. All outputs can be operated simultaneously.
- Crystal controlled for high stability and performance.
- Uses micro-controller technology that can be re-programmed to suit unique applications.
- Momentary, latching and security latching output modes is user selectable.

Applications

- Automatic gates.
- Security systems.
- Simple on/off functions.

Description

The GIGALINK™, GLR4330812R is the **most advanced Remote Control technology** available in the world today. GIGALINK™ is an invention that has revolutionised the entire Remote Control technology including Elsema's earlier version of FMT- ... and FMR- ... series.

The GLR43308 state-of-the-art invention brings a new dimension in the world of Remote Control technology in domestic, **commercial and industrial** applications.

The innovative microcontroller technology replaces the traditional dip switch coding which **eliminates** any possible **code grabbing**. Special features such as over four billion code combinations and ability to program any number of transmitters to a receiver adds up to the most advanced and secure Remote Control available.

Code Programming

For code programming, please refer to the separate programming instructions.

Applications

The GLR43308 receiver outputs can be set to different modes which allows it to be used in many diverse applications such as security, industrial machine monitoring, crane control, level monitoring, multiple on/off functions etc.

Unique Code System

The microcontroller EEPROM allows large volume users to have a unique code. This enables Elsema to offer everyone "your own" radio control.







When programming is completed and the GIGALINK cable is removed from the receiver-coding socket, the 4-way dip switch is used to select different output modes. This is described below.

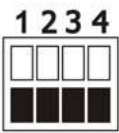
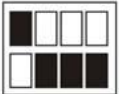
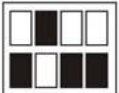

Different Modes for each Output

Modes are user selectable from the 4-way dip switch, shown below.

(Dipswitch 4 is reserved for specific customer mode. Normally not used.)

		DIP Switch Mode Settings
		The output relay will respond in the following manner when receiving the correct signal from a transmitter
	All OFF	"All Momentary": Relay on, only while correct signal is received
	1 ON	"All Latching": Outputs alternate at every correct incoming signal
	2 ON	"Momentary & Latching": Outputs 1-4 are momentary & 5-8 are latching
	1 & 2 ON	"Security Latching on": Outputs will be on until supply to receiver is momentarily interrupted
	3 ON	"Momentary & Latching ": Outputs 1-6 are momentary & 7-8 are latching
	1 & 3 ON	"Momentary & Latching ": Outputs 1-2 are momentary & 3-8 are latching
	2 & 3 ON	"Momentary & Latching ": Outputs 1-3 are momentary & 4-8 are latching
	1, 2 & 3 ON	"Security Latching on": Output 1 is security latching & 2-8 are momentary

*** Dipswitch 4 is reserved**

Momentary - Output is active for as long as the transmitter button is pressed.
This is a standard mode on most automatic gates or garage door openers.

Latching - Output remains active until next press of the transmitter button.
Similar to switching "on" and "off" a light.

Security Latching - Output remains active until power to the receiver is removed. Similar to security alarms and fire alarms.











Customised Software

Custom output modes can be programmed to do special functions. Call Elsema for more details.

Case

The GLR43308R can be supplied without a case, this allows the receiver to be integrated according to your needs. The C1217 case (weather proof) can be used to enclose the GLR43308R receiver. The receiver with a case is known as a GLR43308RE.

Products in the Range

				
GLR43301 1-Channel	GLR43301240 1-Channel, 240V	GLR43302 2-Channel	GLR43302240 2-Channel, 240V	GLR4330312, 3-Channel, 12 - 24V
				
GLR4330412 4-Channel, 12 - 24V	GLR43304240 4-Channel, 240V	GLR43308 8-Channel	GLR43308R 8-Channel Relay Output	GLR43302SS Receiver with 6-way female connector GLR43302SST Receiver with terminal block

Technical Data

Supply Voltage	12 – 24 Volts AC or DC. Can use Elsema’s AC power pack (12PP-1000) Supply lines should be less than 3 metres long to comply with radio frequency authorities
Current Consumption	10mA standby, 340mA if all outputs “On”
Receiving Freq	433.920MHz (Other frequencies available on request. Refer to the table below)
Operating Temperature Range	-5 to 50°C
Outputs	Eight change over relay outputs, each rated at 8 Amps/240 Volts
Connections	Screw type terminal block.
Antenna	Elsema’s ANT433MHz series antennas or piece of approximately 690 mm long wire for short range applications.
Dimensions	130 x 95 x 45mm
Mounting hole size	3.97 mm or 5/32"
Mounting Hole Spacing	Length 120 mm Width 60 mm
Useable Transmitters	All Elsema Type 433MHz GLT-... series

Available Frequencies

SF2	433.664 MHz
SF3	433.408 MHz
SF4	433.152 MHz
SF5	434.688MHz
SF6	434.432 MHz

Special Frequency products can be made upon request. There is a minimum quantity order of 20. Please quote Correct SF number when ordering transmitters on special frequencies.

Block Diagram

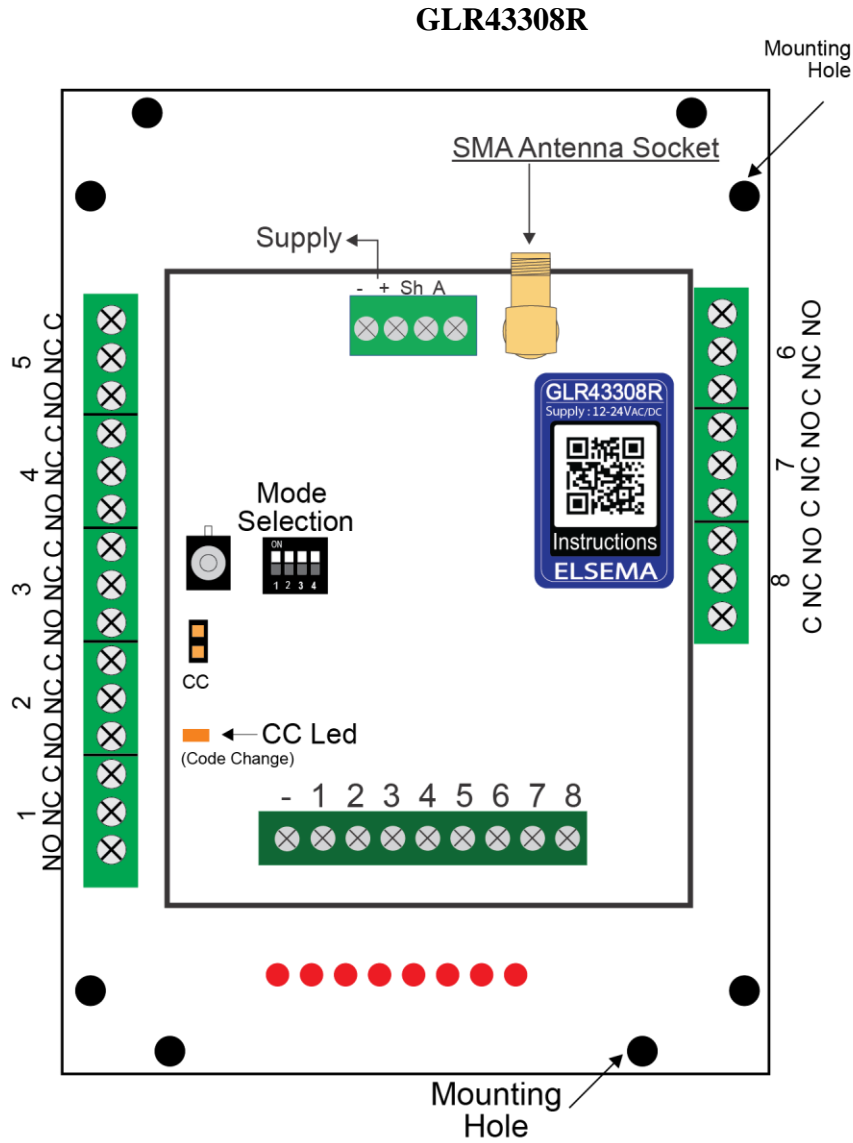

Manufactured by

Elsema Pty Ltd
 31 Tarlington Place, Smithfield
 NSW 2164, Australia.
 Ph: 02 9609 4668
 Website: <http://www.elsema.com>

Distributed by

