

# MCR91516SS and MCR91516R

16-Channel, 915MHz Receiver with Frequency Hopping

## Features

- Frequency hopping between 915 to 928MHz
- Eight channels with simultaneous channel reception
- Digital Coding, 12-way dipswitch or encrypted coding
- Crystal Controlled for high stability and accuracy
- Can operate several transmitters and receivers next to each with no interferences or jamming
- On-board Red LED to indicate reception of a signal
- Two versions available
  - MCR91516SS open collector output
  - MCR91516R relay output
- Wide operating supply voltage and low current consumption

## Applications

- Industrial Automation, eg Crane Control, winches, wireless cement truck operation
- Equipment and machinery control
- Security and Automotive Systems
- Advanced home automation i.e. Alarms, gates, doors, garden lights, swimming pool control etc.



<p style="text-align: center;"><b>MCR91516SS</b> 16 Channel Receiver with 16 Open Collector Outputs</p>	<p style="text-align: center;"><b>MCR91516R</b> 16 Channel Receiver with 16 Relay Outputs</p>

## Description

The receivers use fast frequency hopping (FFH) to allow up to eight receivers to be used in the same area. No interference or jamming will occur. The FFH technology is usually used in very expensive equipment with military or medical applications.

The receivers use a dual digital coding called Multicode Technology (MCR). This MCR digital coding can be either the 12-way dipswitch or the encrypted coding.







The 12-way dip switch allows for simple programming and involves the user to simply match the 12-way dip switch on both the transmitter and receiver. The encrypted coding is a random generated code which is programmed wirelessly to the transmitter and receiver. The encrypted code is usually used when more codes are required for high security applications. See setup instructions for more details on the dipswitch and encrypted coding. The combination of FFH and MCR technology brings you a very sophisticated receiver yet easy to use.

Connecting Elsema's ANT915-SMA to the receivers SMA connector will increase the operating range.

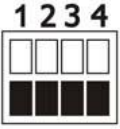
**Different Modes for each Output**

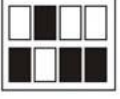
Modes are user selectable from the 4-way dip switch, shown below.

(Dipswitch 4 is reserved for specific customer mode. Normally not used.)

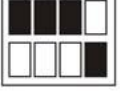
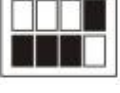
		<b>DIP Switch Mode Settings</b>
		The output relay will respond in the following manner when receiving the correct signal from a transmitter
	All OFF	"All Momentary": Relay on, only while correct signal is received
	1 ON	"All latching ": Outputs alternate at every correct incoming signal
	2 ON	"Momentary & Latching ": Outputs 1-8 are momentary & 9-16 are latching
	1 & 2 ON	"Security Latching on": Outputs will be on until supply to receiver is momentarily interrupted
	3 ON	"Momentary & Latching ": Outputs 1-12 are momentary & 13-16 are latching
	1 & 3 ON	"Momentary & Latching ": Outputs 1-4 are momentary & 5-16 are latching
	2 & 3 ON	"Momentary & Latching ": Outputs 1-6 are momentary & 7-16 are latching
	1, 2 & 3 ON	"Security latching & Momentary ": Output 1 & 2 is security latching & 3-16 are momentary
	4 ON	" Security Latching & Momentary ": Outputs 1-14 are security latching & 15-16 are Momentary

**Factory Default = Momentary**

**Momentary** - Output is active for as long as the transmitter button is pressed.  
*This is a standard mode on most automatic gates or garage door openers.*













**Latching** - Output remains active until next press of the transmitter button.  
*Similar to switching "on" and "off" a light.*

**Security Latching** - Output remains active until power to the receiver is removed. Similar to security alarms and fire alarms. To activate the security latching mode, a link needs to be soldered into the hole marked as latching.

**Customised Software**

Custom output modes can be programmed to do special functions. Call Elsema for more details.

**Products in the Range**

			
<p><b>MCR91502P</b> 2-Channel 915MHz Receiver with <b>Open Collector</b> Output</p>	<p><b>MCR91502PT</b> 2 Channel Receiver with 5- way screw type Terminal</p>	<p><b>MCR91501R</b> 1-Channel 915MHz Receiver with <b>Relay</b> Output</p>	<p><b>MCR91502R</b> 2-Channel 915 MHz Receiver with <b>Relay</b> Output</p>
			
<p><b>MCR91503R</b> 3-Channel 915MHz Receiver with <b>Relay</b> Output</p>	<p><b>MCR91504R</b> 4-Channel 915MHz Receiver with <b>Relay</b> Output</p>	<p><b>MCR91508SS</b> 8-Channel 915MHz Receiver with <b>Open Collector</b> Output</p>	<p><b>MCR91508R</b> 8-Channel 915 MHz Receiver with <b>Relay</b> Output</p>
			
<p><b>MCR91512SS</b> 12-Channel 915MHz Receiver with <b>Open Collector</b> Output</p>	<p><b>MCR91512R</b> 12-Channel 915MHz Receiver with <b>Relay</b> Output</p>	<p><b>MCR91516SS</b> 16-Channel 915MHz Receiver with <b>Open Collector</b> Output</p>	<p><b>MCR91516R</b> 16-Channel 915 MHz Receiver with <b>Relay</b> Output</p>

**Antenna**

The receiver has a 50 ohms SMA connector to allow a proper 915MHz antenna to be connected. Elsema stocks the ANT915S-SMA suitable for connection to the receiver. See picture below.

**Case**

The C1722 case and QM100 mounting bracket can be used to enclose the MCR91516SS receiver into a case. The MCR91516R only needs the C1722 case since the board screws directly onto the case screw studs.

The MCR91516SS or MCR91516R can be supplied without a case, this allows the receiver to be integrated according to your needs.

**Technical Data**

	<b>MCR91516SS</b>	<b>MCR91516R</b>
Supply Voltage	12 – 24 Volts AC or DC. Can use Elsema's AC power pack (12PP-1000)	
Current Consumption	30 mA stand by at 12VDC	30 mA stand by at 12VDC & 350mA with 16 relays "On"
Frequency Band	915 to 928 MHz for Australia 915 to 927 MHz for New Zealand 921 to 928 for United States of America and Canada	
Operating Temperature Range	-5 to 50°C	
Decoding System	On board 12-way code switch (4096 Codes) Encrypted coding (Over 16 million codes)	
Outputs	16 Open collector outputs. All outputs can be ON simultaneously with each output current being 125mA. Outputs can hold 40 Volts in "Off" state	Sixteen change over relay outputs, rated at 8 Amps 240VAC
Antenna	ANT915S-SMA	
Mounting hole size	3.97 mm or 5/32"	
Case	Optional C200 plastic case	
Dimensions	95 x 70 x 27 mm	185 x 94 x 55 mm
Useable Transmitters	All Elsema type MCT915xx series	
Operating range	Up to 400 metres	

**Block Diagram**

**MCR91516SS**

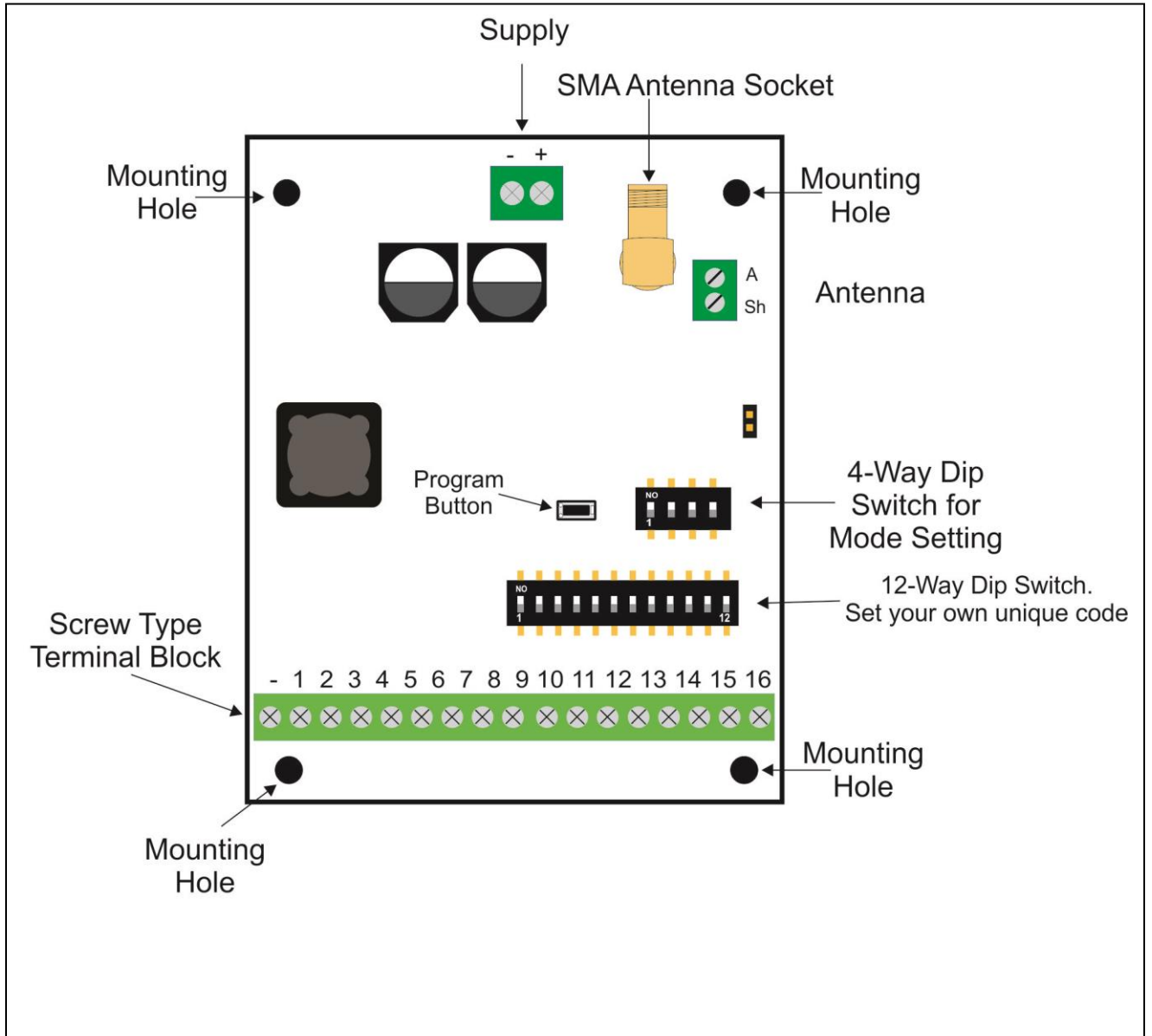

**MCR91516R**

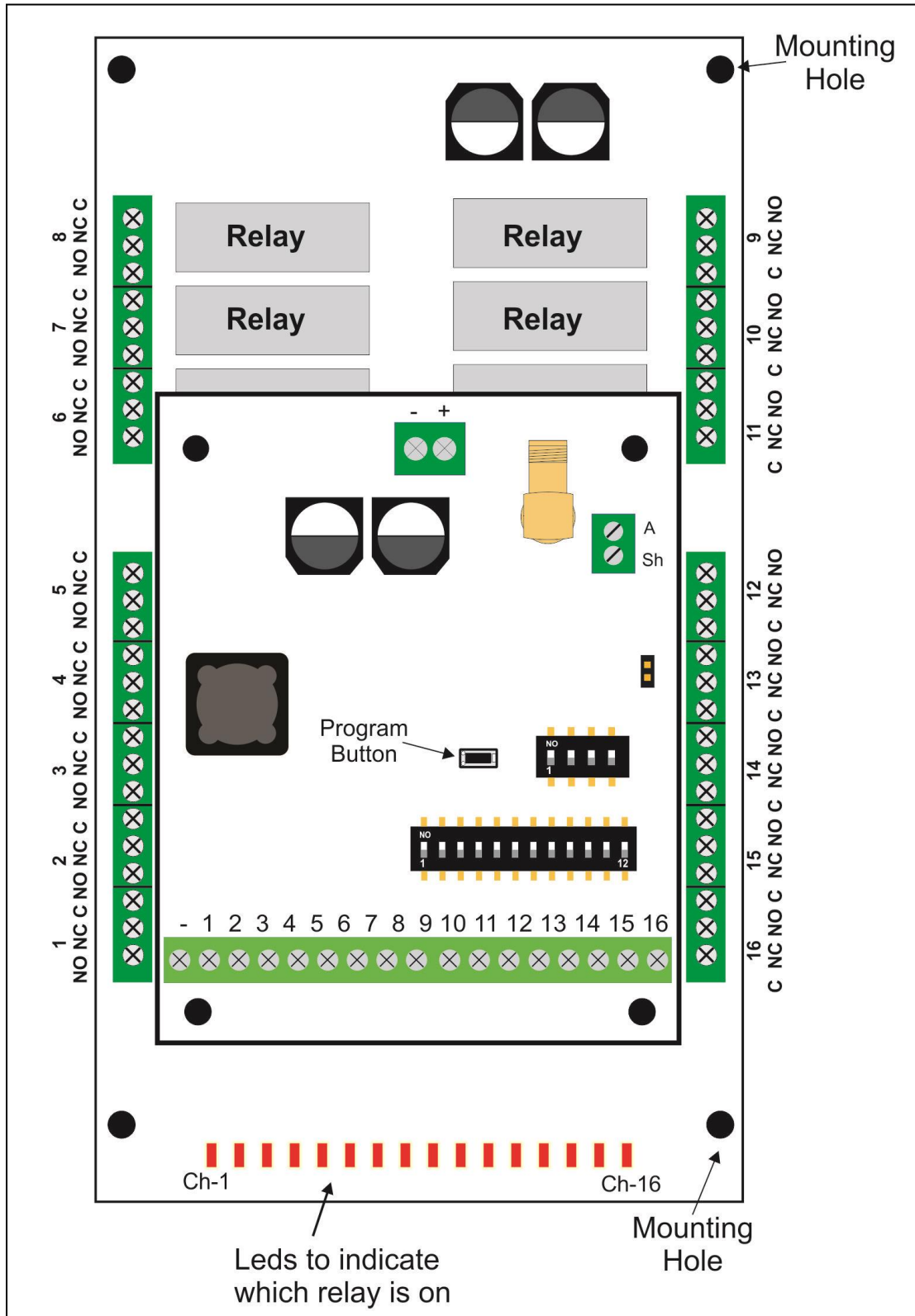

**Application Notes (MCR91516SS)**

Care should be taken with the open collector outputs that they are protected from inductive loads. This is done by connecting diodes across your DC inductive load. See diagram below

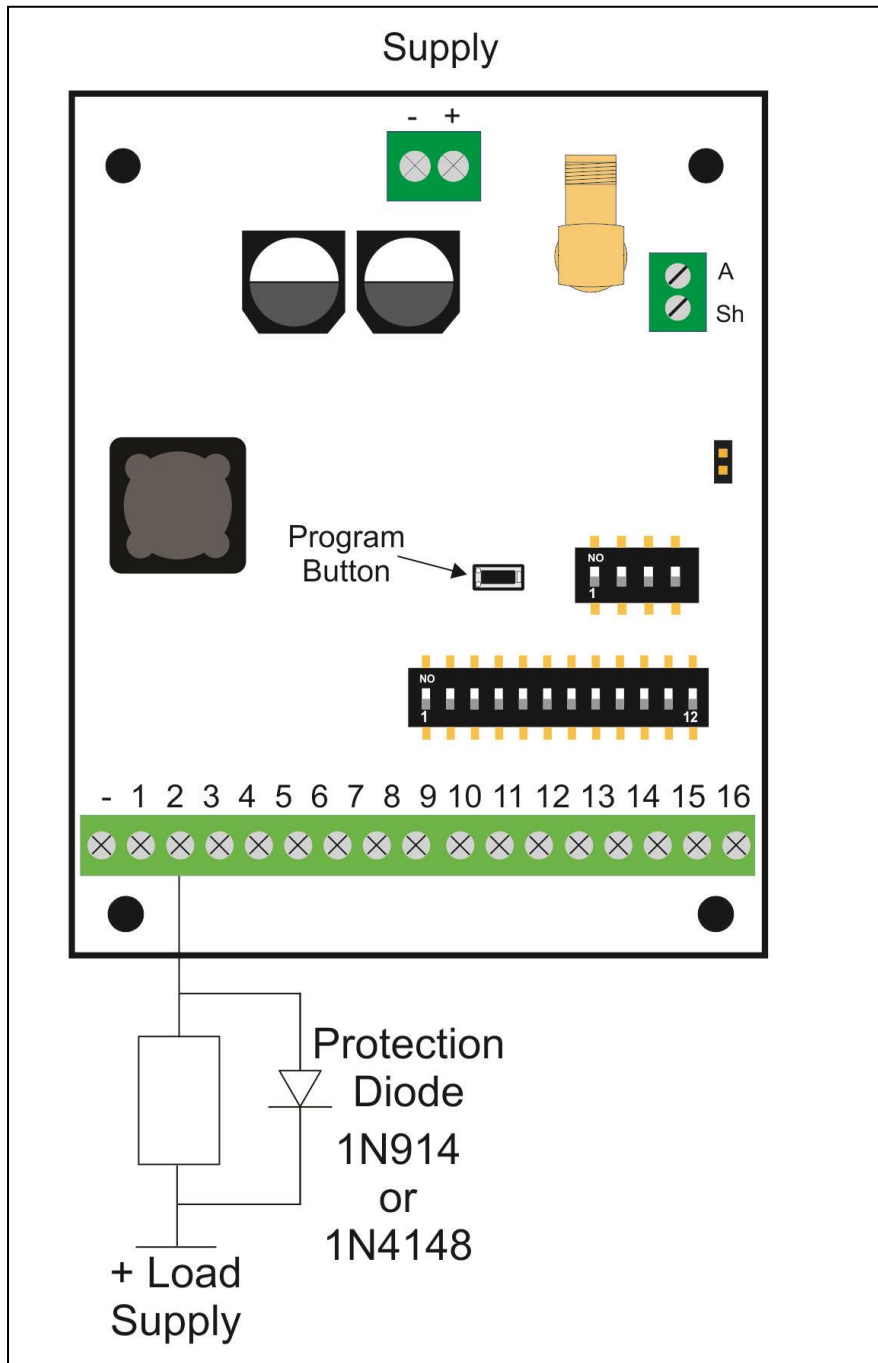

**12-Way Dipswitch Setup Instructions**

To program the transmitter to the receiver you simply match the transmitter and receiver dipswitches. Do not use all dipswitches in the off position. This sets the transmitter to encrypted coding. See encrypted coding instructions.

To avoid interference or jamming from other MCT series transmitters make sure that the first 8 dip switches (Dipswitch 1 to 8) are different. The first 8 dipswitches select different frequencies.

**Advanced Dipswitch Programming Features**

This feature allows the user to configure very sophisticated systems by mixing and matching different MCT transmitters to MCR receivers.

Dipswitches 9, 10, 11 and 12 will determine the position of the first channel on the transmitter and receiver. Other channels are automatically sequentially placed.

Relay	DS9	DS10	DS11	DS12
Position 1	0	0	0	0
Position 2	0	0	0	1
Position 3	0	0	1	0
Position 4	0	0	1	1
Position 5	0	1	0	0
Position 6	0	1	0	1
Position 7	0	1	1	0
Position 8	0	1	1	1
Position 9	1	0	0	0
Position 10	1	0	0	1
Position 11	1	0	1	0
Position 12	1	0	1	1
Position 13	1	1	0	0
Position 14	1	1	0	1
Position 15	1	1	1	0
Position 16	1	1	1	1

1 = Dip Switch in “On” position, 0 = Dip Switch in “Off” position

**Example:**

Using a 4-channel MCR91504 receiver with a 1-channel MCT91501 transmitter.

If the MCR91504 has 0101 0100 1000 set to the 12 way dipswitch, this sets the receiver first relay (Ch.1) to position 9 i.e. 1000. The other channel addresses are sequentially placed.



This is shown in the table below:

Relay Channel	Position	DS9	DS10	DS11	DS12
1	9	1	0	0	0
2	10	1	0	0	1
3	11	1	0	1	0
4	12	1	0	1	1
5	13	1	1	0	0
6	14	1	1	0	1
7	15	1	1	1	0
8	16	1	1	1	1

To program a 1-button MCT91501 transmitter to receiver relay channel 4 you need to set the transmitters dip switch to 0101 0100 1011.

To program a 2-button MCT91502 transmitter to receiver relay channel 2 and 3 you need to set the transmitter dip switch to 0101 0100 1001. The second button on the transmitter automatically operates relay 3

This example is shown graphically below:

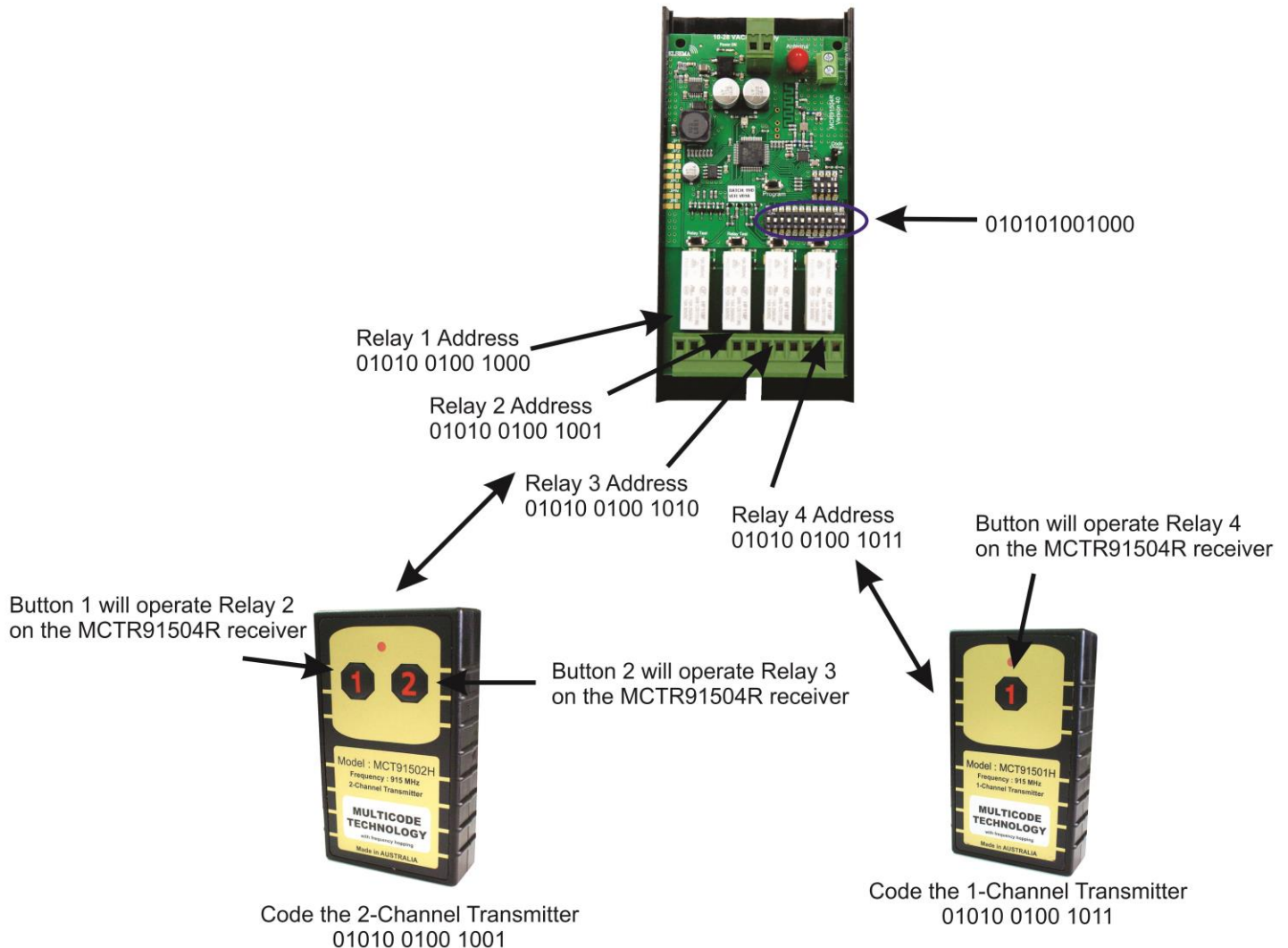

## Encrypted Coding Setup Instructions

To change the transmitter and receiver to encrypted coding set all dipswitches on the 12-way dipswitch to the off position. The encrypted code is a randomly selected code out of 16 million different combinations.

The user can change the code by shorting out the Add/Delete pin on the receiver. The orange LED comes on while the Add/ Delete pins are shorted, to confirm the change of code was successful. If this is done all transmitters and receivers need to be programmed again with the new code.

Any programming combination is possible, for example transmitter to transmitter, receiver to receiver, transmitter to receiver or visa versa.

## Programming Steps

1. Make sure all dip switches are in an off position on all transmitters and receivers.
2. Make sure power is connected to the receiver and transmitter.
3. If programming from a receiver, short out the Add/Delete pin to select a random code. The receivers orange LED comes on to confirm the change of code was successful. Do not do this step if you are adding extra transmitters to the receiver since already programmed units will be deleted.
4. Set one of the units, either receiver or transmitter, to broadcast its code. The broadcaster's code will be programmed to the other units.
  - 4a. To broadcast the receivers code make sure all 12 dipswitches are off and then flick dip switch 12 on and then off. This is confirmed by the green LED being on for 10 seconds.
  - 4b. To broadcast the transmitter code hold down button 1 and flick dip switch 12 on and then off. This is confirmed by the green LED being on for 10 seconds. You can release button 1.
5. While broadcasting the code press button 1 on a different transmitter or receiver for 1 second and then release the button. The orange LED will flash twice to confirm successful programming.

*Broadcasting will be latched on for 10 seconds or stop if any dipswitch is turned on.*

*If orange LED did not flash twice try programming again but move closer to the broadcasting unit.*

During programming all channels are channelised programmed. That is, button 1 to relay 1, button 2 to relay 2, button 3 to relay 3, etc.

This programming method allows a user to program unlimited number of transmitters to the receiver or visa versa. You can even program a transmitter to a new transmitter. You do not need to get access to the receiver.

**Many of the Multicode technology features are industry firsts, so take your time to read the manuals and let the technology take you away. Watch your competitors follow you**

## Manufactured by

**Elsema Pty Ltd**  
31 Tarlington Place, Smithfield  
NSW 2164, Australia.  
Ph: 02 9609 4668  
Website: <http://www.elsema.com>