

# **MCT91508, MCT91512, MCT91516**

## **MCT91508SMA, MCT91512SMA, MCT91516SMA**

915 - 927 MHz Hand Held Transmitter with Fast Frequency Hopping

### **Features include:**

- Available with 8, 12 and 16-channels, 1, 2, 3 or 4 channels are available with a smaller case.
- Fast Frequency Hopping operates on several frequencies for interference or jamming immunity.
- Uses a standard 9-volt alkaline battery.
- 12-way dipswitch (4096 codes) or Encrypted (Over 16 million codes).
- User selectable modes.
- More than 1 button can be press at a time, i.e. simultaneous channel transmission.
- Flashing LED indicates a flat battery.
- Can operate several transmitters next to each other with no interferences or jamming.
- Available with standard Elsema labels or custom labels.
- Standard version includes an internal pre-tuned antenna.
- SMA version allows connection of an external antenna for long range applications. More than 350 metres.
- User can enable return acknowledgment signal or maintain link feature.
- Each transmission includes a CRC checksum for a high level of security and reliability, even in the nosiest electrical environments.
- Built in Electro Static Protection (ESD).



### **Typical Applications**

- Industrial and commercial automation systems.
- Industrial monitoring.
- Security and Automotive Systems.
- Remote Keyless Entry for high Security Sites.
- Equipment and machinery control, eg Crane Control, winches, cement truck operation, lights etc
- Advanced home automation, eg Alarms, gates, doors, garden lights, swimming pool control etc

### **General Description**

The transmitters use fast frequency hopping (FFH) to allow up to eight transmitters to be used in the same area. No interference or jamming will occur. The FFH technology is usually used in very expensive equipment with military and medical applications. Elsema has developed a world first low cost, light weight hand held FFH transmitter.

The transmitters use a dual digital coding called Multicode Technology (MCT). This MCT digital coding can be either the 12-way dipswitch or the encrypted coding.

The 12-way dip switch allows for simple programming and involves the user to simply match the 12-way dip switch on both the transmitter and receiver. The encrypted coding is a random generated code which is programmed wirelessly to the transmitter and receiver. The encrypted code is usually use when more codes are required for high security applications. See setup instructions for more details on the dipswitch and encrypted coding.

The combination of FFH and MCT technology brings you a very sophisticated transmitter yet easy to use.

The MCT series transmitters are the first hand held Elsema transmitter to allow an external antenna to be connected. Connecting Elsema’s ANT915mini to the transmitters SMA connector will increase the transmitting range to over 350 metres.

**Accessories (Available Separately)**













<b>Silicone cover (SIL08)</b>	<b>9V Alkaline Battery (6LR61)</b>	<b>915MHz Antenna ANT915MINI</b>	<b>Rubber Boots for all Hand Held Transmitters in MCT Series</b>

Pictures are for illustration purposes only. Final product may differ.

**Technical Data**

<b>Supply Voltage</b>		9-Volt Alkaline Battery (Absolute maximum 11.0 Volts)
<b>Current Consumption</b>		65.00mA
<b>Standby Current</b>		5 uA
<b><u>LED</u></b>	<b>Flashing Red LED</b>	Replace battery, battery at 6 volts
	<b>Orange LED Flashes</b>	Encrypted code successfully programmed.
<b>Operating Frequencies</b>		915 to 928 MHz for Australia 921 to 929 MHz for New Zealand 902 to 928 for United States of America and Canada
<b><u>Antenna</u></b>	<b>Standard Version</b>	Built-in PCB proprietary track
	<b>SMA Version</b>	ANT915mini (Included with SMA version transmitter)
<b>Dual Digital Coding System</b>		12-way dip switch (4096 Codes) Encrypted coding (Over 16 million codes)
<b>Operating Temperature</b>		-20° to +70° Celsius
<b>Radiated Field Strength</b>		75dBuV/m at 3 metres
<b>EIRP</b>		80uW
<b><u>Dimensions</u></b>	<b>With Case</b>	130 x 67 x 27mm
	<b>No Case, NC</b>	81 x 56 x 12 mm
<b>Weight</b>		50 g (Excluding battery)
<b><u>Operating Range</u></b>	<b>MCT91508/12/16 series</b>	Up to 150 metres
	<b>SMA version with ANT915mini</b>	<u>More than 350 metres</u>
<b>Compatible Receivers</b>		All MCR915 series

**Products in the Range**

		
<p><b>MCT91508</b></p>	<p><b>MCT91512</b></p>	<p><b>MCT91516</b></p>
		
<p><b>MCT91508SMA, longer transmission range</b></p>	<p><b>MCT91512SMA, longer transmission range</b></p>	<p><b>MCT91516SMA, longer transmission range</b></p>
		
<p><b>MCT91508NL, No Label</b></p>	<p><b>MCT91512NL, No Label</b></p>	<p><b>MCT91516NL, No Label</b></p>
		
<p><b>MCT91508NC, No Case</b></p>	<p><b>MCT91512NC, No Case</b></p>	<p><b>MCT91516NC, No Case</b></p>

**1, 2, 3 and 4 Channel**

The 1, 2, 3 and 4 channels are available in the smaller case.

MCT91501, One Button. MCT91502, Two Buttons. MCT91503, Three Buttons and MCT91504, Four Buttons.

See 1, 2, 3 and 4 channel data sheet for more details.

**Return Acknowledgment and Maintain Link Features**

The transmitters have two pairs of solder pads labelled JP1 and JP2. You will need to remove the battery and back cover to see the JP pads.

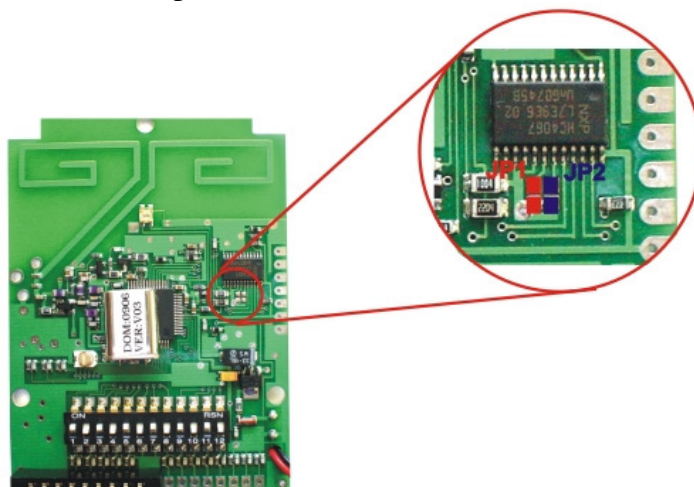

**Return Acknowledgment:**

If **JP1** is shorted in the transmitter only then a return acknowledgment is enabled.

If the receiver is in momentary mode the return acknowledgment on the transmitter will be 3 green flashes.

If the receiver is in flip flop mode and relay is “ON” then the return acknowledgment will be 2 green flashes.

If the receiver is in flip flop mode and relay is “OFF” then the return acknowledgment will be 2 red flashes.

<b>Transmitter LED</b>	<b>Receiver Mode</b>
3 Green Flashes	Momentary
2 Green Flashes	Flip Flop: On
2 Red Flashes	Flip Flop: Off

It is recommended using the return acknowledgment feature for short range applications, up to 40 metres, since the transmitter does not have a full length receiver antenna built inside.

Return acknowledgment is only available with the 1, 2, 3 and 4 channel MCR receivers with the ack software.

Order Codes:

MCR91501ack for 1-channel,

MCR91502ack for 2-channel,

MCR91503ack for 3-channel,

MCR91504ack for 4-channel

**Maintain Link:**

If **JP2** is shorted in the transmitter then a **maintain link** feature is enabled.

The maintain link feature is supervised every 1 second to continue operations. If the link is lost than a safety shutdown occurs in the receiver. That is, all receiver relays will switch off. If the link is re-established a button on the transmitter needs to be pressed to activate the receiver again.

If there is no button pressed for 5 minutes on the transmitter and the link is maintained the receiver does a safety shutdown and the transmitter goes to sleep. This conserves your battery power. To reactivate the receiver a button has to be pressed on the transmitter.

**Customised labels**

The transmitters are available without the front labels. Customers can purchase the MCT91508NL, MCT91512NL, MCT91516NL, which is a hand held transmitter without the front labels. This enables the customers to fit their custom made labels that can be a 8, 12 or 16 channels. Details of label dimensions are given below.

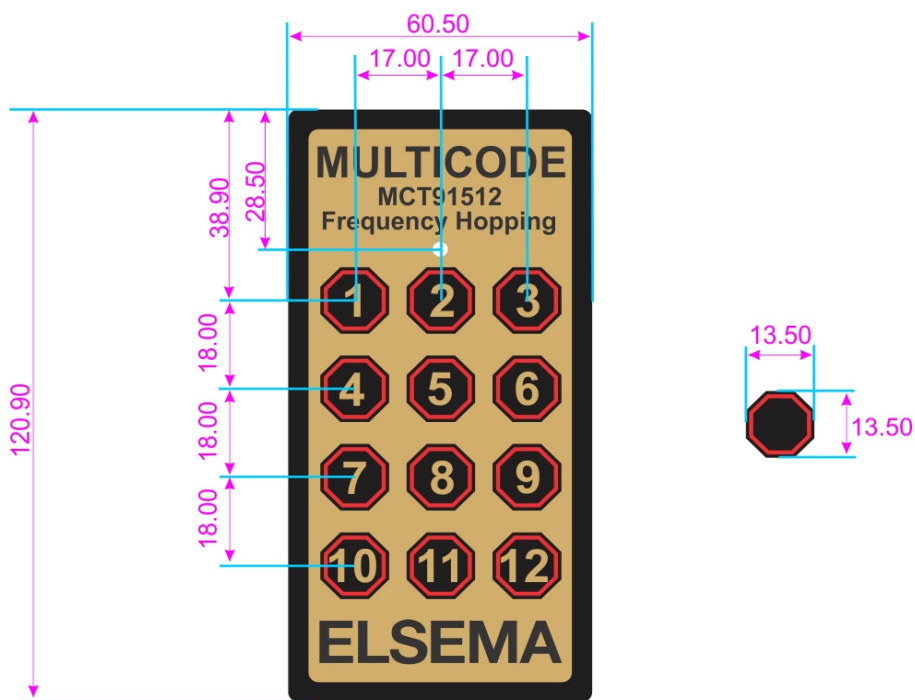
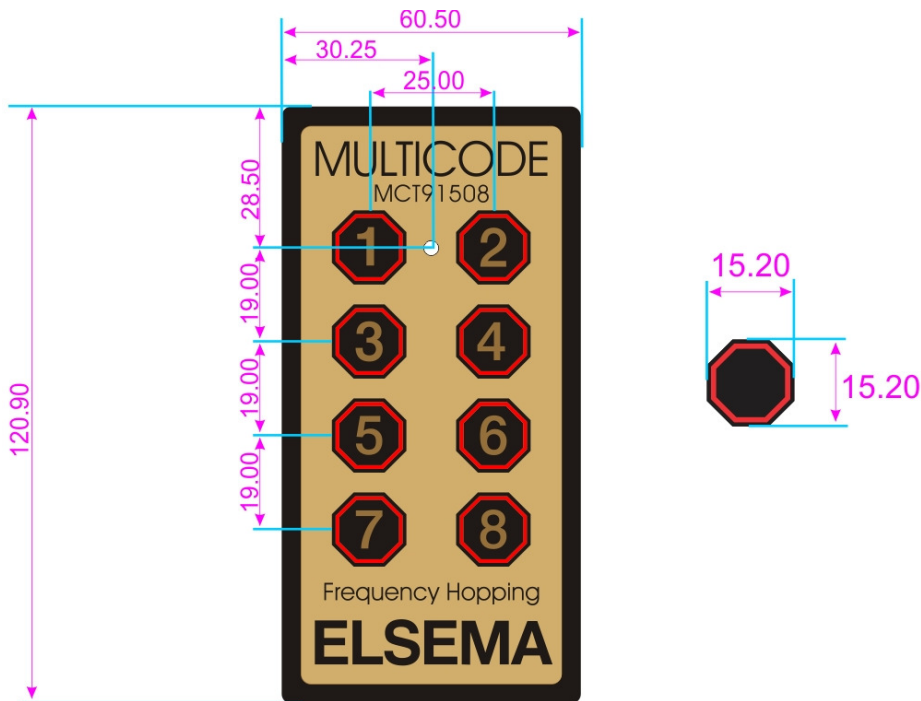

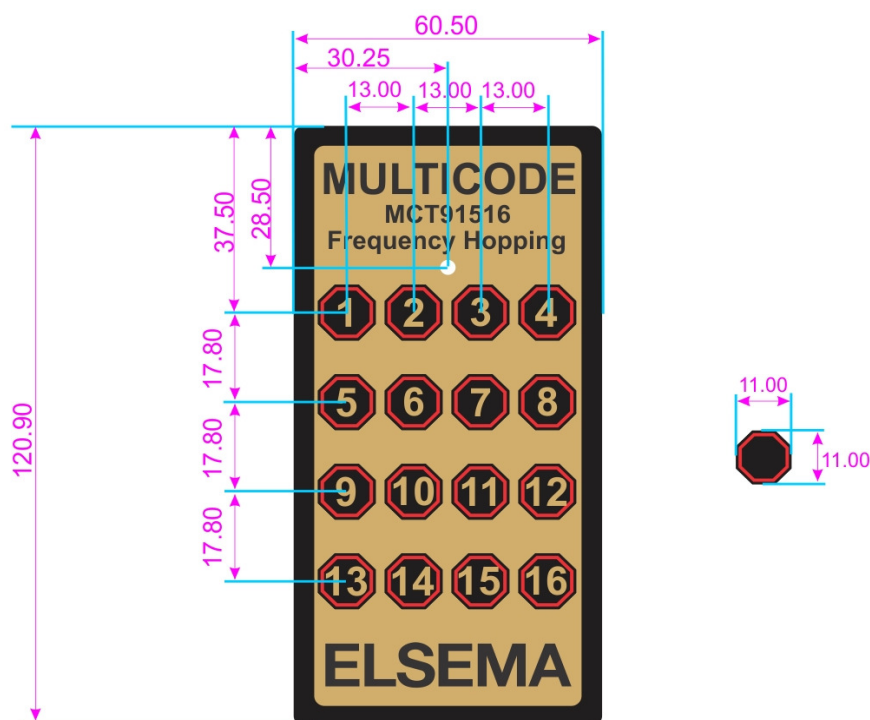

Customers who wish to have their own membranes can contact us with their designs on (+61) 2 9609 4668

You can have your own company logo and specific text printed on the membranes. e.g. Up, Down, Right and Left or Start, Stop etc.

The minimum quantity for custom membranes is 50 pieces per order.

**12-Way Dipswitch Setup Instructions**

To program the transmitter to the receiver you simply match the transmitter and receiver dipswitches. Do not use all dipswitches in the off position. This sets the transmitter to encrypted coding. See encrypted coding instructions.

To avoid interference or jamming from other MCT series transmitters make sure that the first 8 dip switches (Dipswitch 1 to 8) are different. The first 8 dipswitches select different frequencies.

**Advanced Dipswitch Programming Features**

This feature allows the user to configure very sophisticated systems by mixing and matching different MCT transmitters to MCR receivers.

Dipswitches 9, 10, 11 and 12 will determine the position of the first channel on the transmitter and receiver. Other channels are automatically sequentially placed.

Relay	Dipswitch 9	Dipswitch 10	Dipswitch 11	Dipswitch 12
Position 1	0	0	0	0
Position 2	0	0	0	1
Position 3	0	0	1	0
Position 4	0	0	1	1
Position 5	0	1	0	0
Position 6	0	1	0	1
Position 7	0	1	1	0
Position 8	0	1	1	1
Position 9	1	0	0	0
Position 10	1	0	0	1
Position 11	1	0	1	0
Position 12	1	0	1	1
Position 13	1	1	0	0
Position 14	1	1	0	1
Position 15	1	1	1	0
Position 16	1	1	1	1

1 = Dip Switch in “On” position      0 = Dip Switch in “Off” position

**Example:**

Using a 4-channel MCR91504 receiver with a 1-channel MCT91501 transmitter.

If the MCR91504 has 0101 0100 1000 set to the 12 way dipswitch, this sets the receiver first relay (Ch.1) to position 9 i.e. 1000. The other channel addresses are sequentially placed.

This is shown in the table below:

Relay Channel	Position	DS 9	DS 10	DS 11	DS 12	Comment
1	9	1	0	0	0	First Relay, Channel 1 on MCR91504
2	10	1	0	0	1	MCT91502 operates Relay 2 and 3
3	11	1	0	1	0	MCT91502 operates Relay 2 and 3
4	12	1	0	1	1	MCT91501 operates Relay 4

To program a 1-button MCT91501 transmitter to receiver relay channel 4 you need to set the transmitters dip switch to 0101 0100 1011.

To program a 2-button MCT91502 transmitter to receiver relay channel 2 and 3 you need to set the transmitter dip switch to 0101 0100 1001. The second button on the transmitter automatically operates relay 3

This example is shown graphically below:

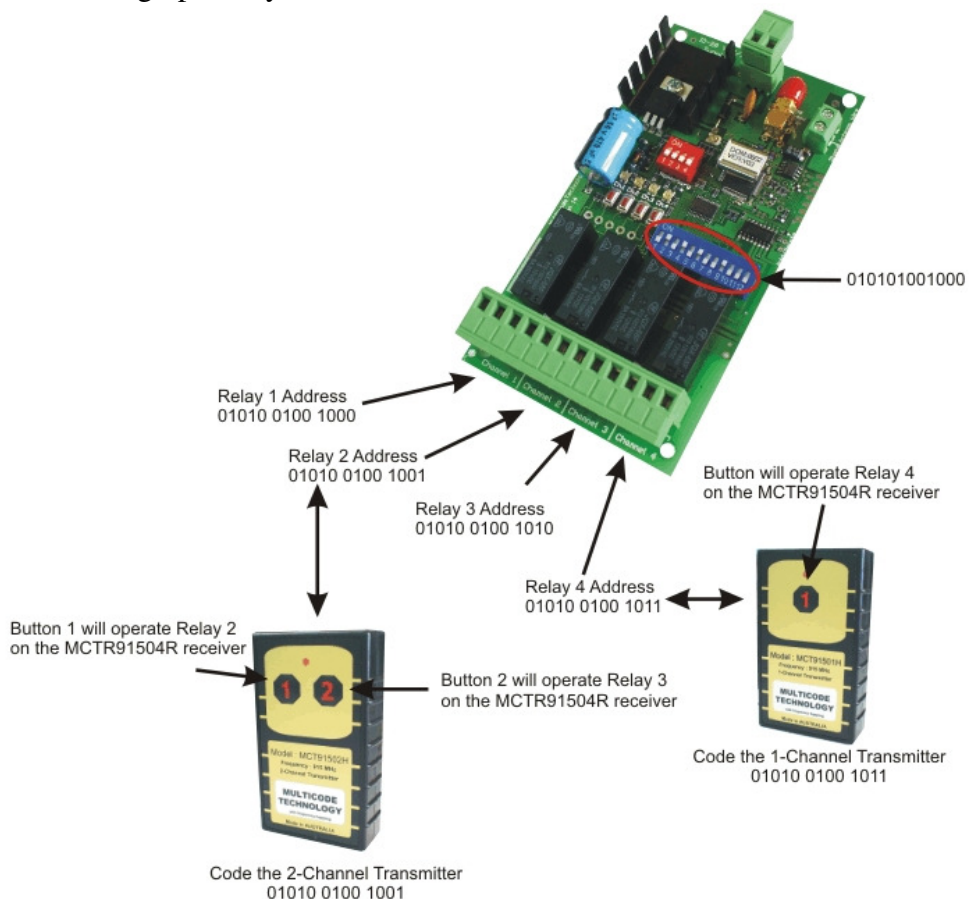



**Encrypted Coding Setup Instructions**

To change the transmitter and receiver to encrypted coding set all dipswitches on the 12-way dipswitch to the off position. The encrypted code is a randomly selected code out of 16 million different combinations.

The user can change the code by shorting out the Add/Delete pin on the receiver. The orange LED comes on while the Add/ Delete pins are shorted, to confirm the change of code was successful. If this is done all transmitters and receivers need to be programmed again with the new code.

Any programming combination is possible, for example transmitter to transmitter, receiver to receiver, transmitter to receiver or visa versa.

**Programming Steps**

1. Make sure all dip switches are in an off position on all transmitters and receivers.
2. Make sure power is connected to the receiver and transmitter.
3. If programming from a receiver, short out the Add/Delete pin to select a random code. The receivers orange LED comes on to confirm the change of code was successful. **Do not do this step if you are adding extra transmitters to the receiver since already programmed units will be deleted.**
4. Set one of the units, either receiver or transmitter, to broadcast its code. The broadcaster’s code will be programmed to the other units.
  - 4a. To broadcast the receivers code make sure all 12 dipswitches are off and then flick dip switch 12 on and then off. This is confirmed by the green LED being on for 10 seconds.
  - 4b. To broadcast the transmitter code hold down button 1 and flick dip switch 12 on and then off. This is confirmed by the green LED being on for 10 seconds. You can release button 1.
5. While broadcasting the code press button 1 on a different transmitter or receiver for 1 second and then release the button. The orange LED will flash twice to confirm successful programming.

***Broadcasting will be latched on for 10 seconds or stop if any dipswitch is turned on. If orange LED did not flash twice try programming again but move closer to the broadcasting unit.***

During programming all channels are channelised programmed. That is, button 1 to relay 1, button 2 to relay 2, button 3 to relay 3, etc.

This programming method allows a user to program unlimited number of transmitters to the receiver or visa versa. You can even program a transmitter to a new transmitter. You do not need to get access to the receiver.

Many of the Multicode technology features are industry firsts, so take your time to read the manuals and let the technology take you away.  
Watch your competitors follow you