

## Statement

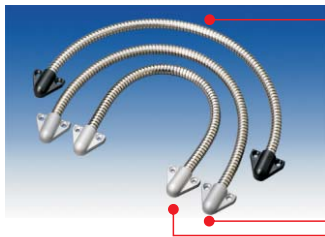

The Door Loops are wire extension protectors that you install on doorframe. It gives attractive and neat result for the wiring; the length of DL-350 and DL-200 metal hose is 40 cm respectively.



DL-200P-40  
DL-200P-40  
DL-200A-30  
Length: 40cm  
Triangle plastic sleeve  
Surface mount

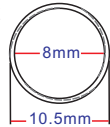

DL-200P-40  
Length: 40cm  
Triangle plastic sleeve  
Surface mount

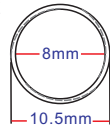

DL-350  
Length: 40cm  
Square aluminum sleeve  
Surface mount

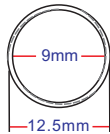

DL-350-SP  
Length: 40cm  
Square aluminum sleeve  
Surface mount



DL-400  
Length: 29cm  
Mortise mount

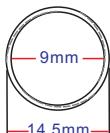

## Dimensions

DL-200P

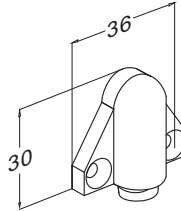

DL-350

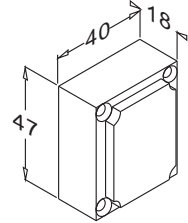

DL-400

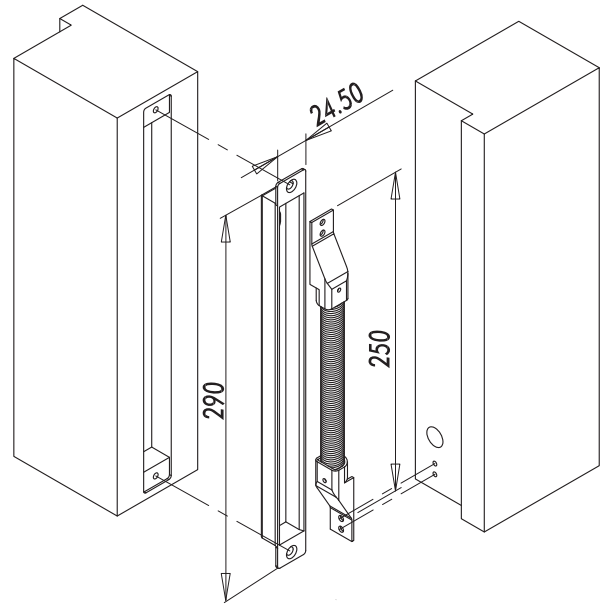

Unit: mm

## Application



DL-200P

## Warranty

The product is warranted against defects in material and workmanship while used in normal service for a period of 1 year from the date of sale to the original client. The GEM policy is one of continual development and improvement; therefore GEM reserves the right to change specifications without notice.

## GIANNI INDUSTRIES, INC.



### DL-500

- ▶ Length: 29cm
- ▶ Stainless steel flex tube
- ▶ Mortise mount
- ▶ Patent-pending oval-angle box, easy to install

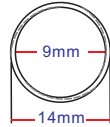

### ● Dimensions

