

Quick Installation Guide

5GHz 867Mbps ipMAX ac Gigabit BaseStation BSS9

Package contents

- Base station x 1
- Metal strap x 1
- PoE injector x 1
- Quick installation guide x 1
- Power cord x 1
- Grounding screw (PM3*6 mm) x 1

For product or function details, please go to www.ip-com.com.cn.

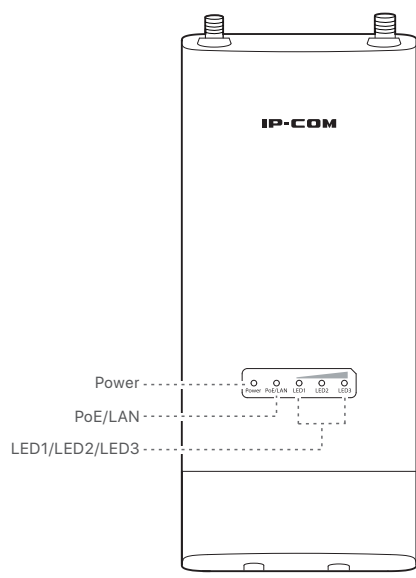

LED indicators

LED Indicators	Status	Description
Power	Solid on	The device is powered on properly.
	Off	The device is not powered on or not powered on properly.
	Solid on	The port is connected properly, but no data is transmitted.
PoE/LAN	Blinking	Data is being transmitted over the port.
	Off	The port is not connected, or not connected properly.
LED1, LED2, LED3 (Received signal strength indicator)	Solid on/Blinking	The Base Station is successfully bridged or connected to other devices. <ul style="list-style-type: none"> • Solid on: The Base Station works in AP, Repeater, P2MP or Router mode. • Blinking: The Base Station works in Client, Universal repeater or WISP mode. Each LED indicator is set with a received signal strength value, which is the threshold for the corresponding LED indicator to light up. You can judge the connection quality through the status of these indicators. The default values are shown below.
	Off	You can change the values on the Wireless > Advanced page in the web UI of the Base Station.
	Off	No device is connected to the Base Station in a wireless manner, or the received signal strength does not reach the maximum value (-90dBm by default) for any LED indicator to light up.

Port/button

Port/Button	Description
GND	Grounding terminal. Use a grounding cord and included grounding screw to connect the grounding terminal to the earth or building for surge and lightning protection.
Reset	Reset Button. When the Power LED indicator lights solid on, hold down this button for about 8 seconds, then release it when all the LED indicators light up. The Base Station is reset successfully.
PoE/LAN	10/100/1000 Mbps auto negotiation port for both power input and data transmission. You can use an Ethernet cable (CAT5e or better Ethernet cable is recommended) to connect this port and the PoE injector for power supply. The length of the Ethernet cable should not exceed 60 meters.

Install the device

Tips

The Base Station can work with the dish, sector or other antenna (purchased separately). If you purchase the IP-COM antenna, or this Base Station fits to the bracket of the antenna you purchased, you can choose bracket mounting to install the Base Station; otherwise, you can choose pole mounting.

Bracket mounting

1. Press the handle on the mounting bracket, align the four hooks on the rear panel of the Base Station with the four slots on the bracket, and slide the Base Station to fix it onto the bracket.
2. Remove the plastic screw caps on the RP-SMA connectors of the Base Station.
3. Connect one side of two RF coaxial cables (enclosed with the antennas) to the RP-SMA connectors of the Base Station.

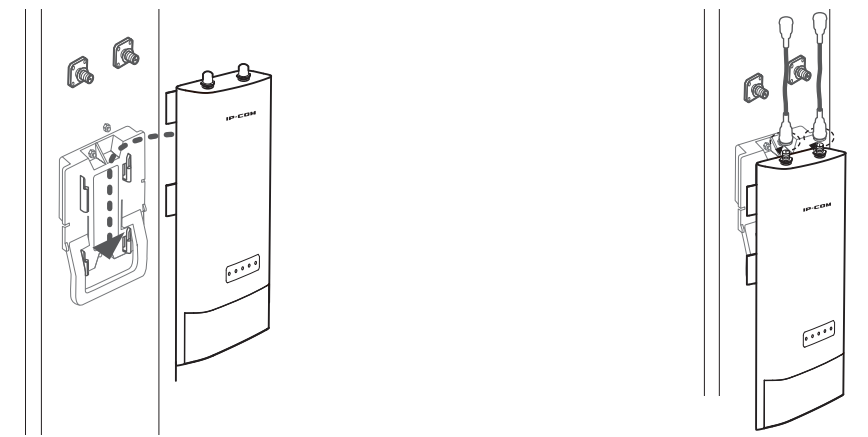

4. Connect the other side of the RF coaxial cables to the connectors of the antenna.

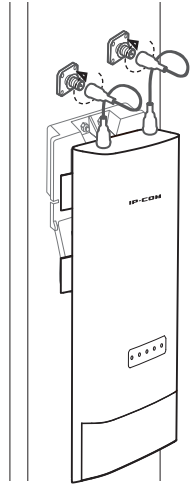

Pole mounting

1. Use a screwdriver to loosen the metal strap by turning the screw counter-clockwise.
2. Straighten out the end of the metal strap, and thread it through the back of the Base Station. Then wrap the metal strap around the pole, and tighten the strap by turning the screw clockwise using the screwdriver.

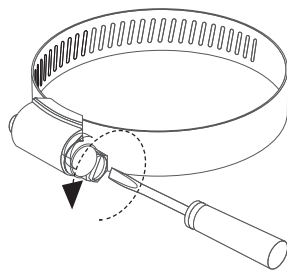

3. Remove the plastic screw caps on the RP-SMA connectors of the Base Station.
4. Connect one side of two RF coaxial cables (enclosed with the antennas) to the RP-SMA connectors of the Base Station.

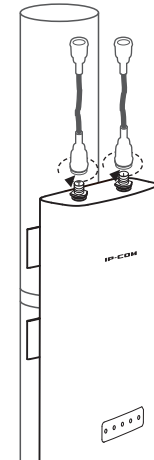

5. Connect the other side of the RF coaxial cables to the connectors of the antenna.

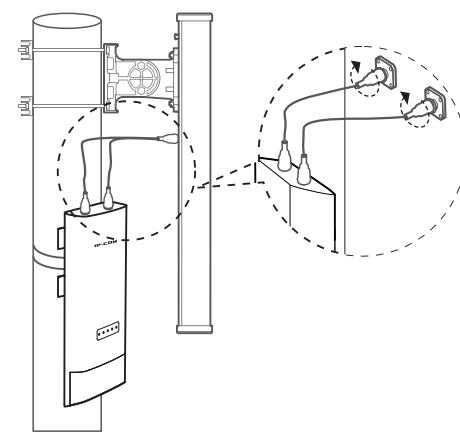

Grounding

Connect the GND terminal of the Base Station to a grounding terminal connected to the earth or building to protect the Base Station from overvoltage and overcurrent caused by lightning and ESD.

1. Connect one side of a grounding cord to the included grounding screw.
2. Connect the grounding screw to the GND terminal of the Base Station, and tighten it.
3. Connect the other side of the grounding cord to the grounding terminal connected to the earth or building.

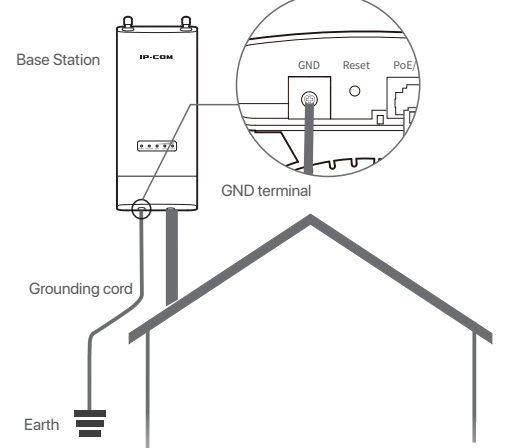

Scenario 1: PtP backhaul connection with dish antennas

One Base Station in **AP** mode and another one in **Client** mode create a long distance wireless connection for point to point connection.

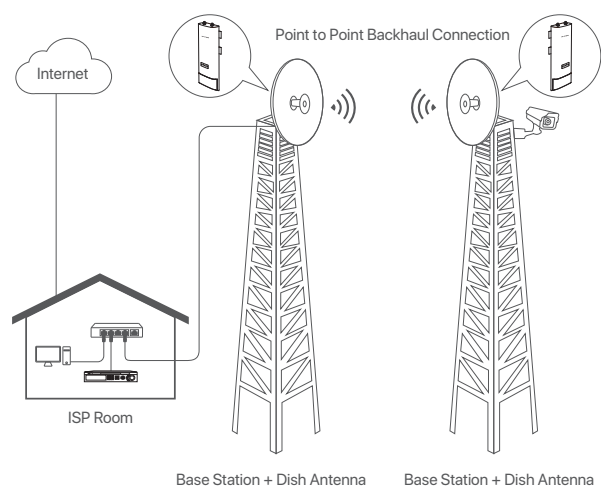

- Step 1:** Place two Base Stations next to each other.
- Step 2:** Power on Base Station 1 and connect it to a computer.
1. Remove the cover of the Base Station 1.
 2. Use an Ethernet cable to connect the **PoE/LAN** port of the Base Station 1 to the **PoE** port of the PoE injector.
 3. Use the included power cord to connect the PoE injector to a power source. The **PoE/LAN** LED indicator of the Base Station 1 lights up.
 4. Use an Ethernet cable to connect the **LAN** port of the PoE injector to a computer.

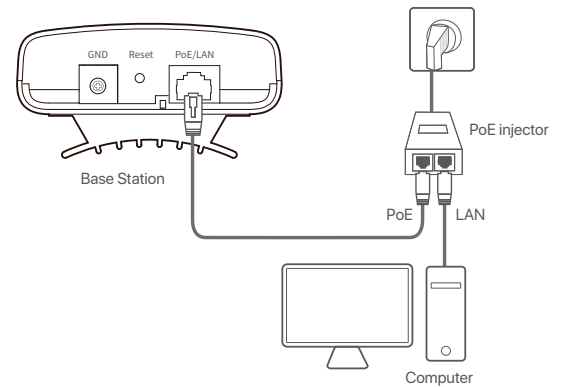

- Step 3:** Set the Base Station 1 to **AP** mode.
1. Start a web browser on the computer, and visit **192.168.2.1**. Enter your user name and password, and click **Login**.

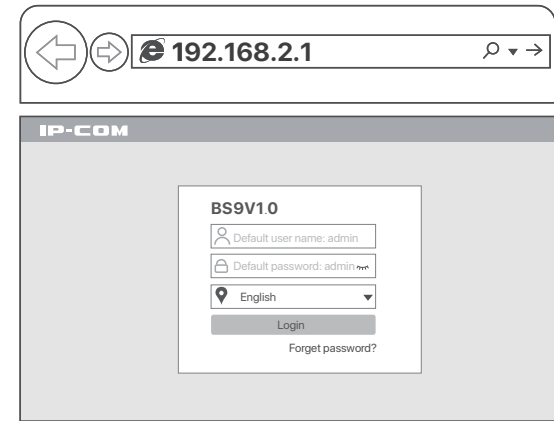

Tips
If the login page does not appear, please refer to **Q1** in **FAQ**.

2. Select **AP**, and click **Next**.

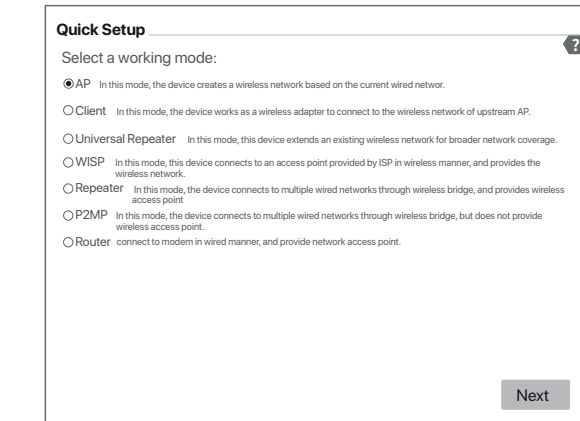

3. Customize your **SSID** (WiFi name) and **Key** (WiFi password), select a **Channel**, a **Security Mode** (WPA2-PSK is recommended), and an **Encryption Algorithm**. Click **Next**. Record the **SSID** and **Key** for later setup.

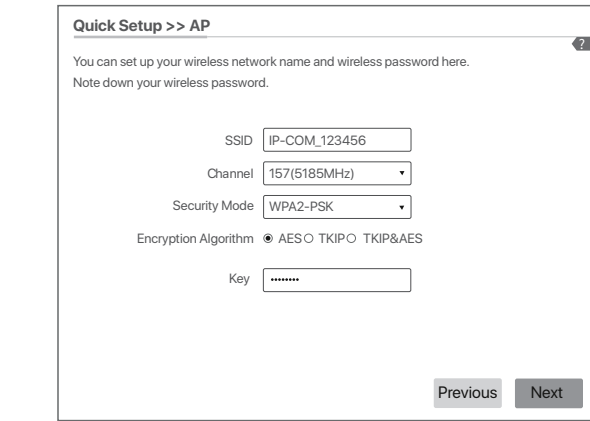

4. Click **Save**, and wait until the Base Station reboots automatically to activate the settings.

- Step 4:** Set the Base Station 2 to **Client** mode.
1. Perform **Step 2** to power on the Base Station 2 and connect it to a computer.
 2. Start a web browser on the computer, and visit **192.168.2.1**. Enter the login user name and password, and click **Login**.



Tips
If the login page does not appear, please refer to **Q1** in **FAQ**.

3. Select **Client**, and click **Next**.

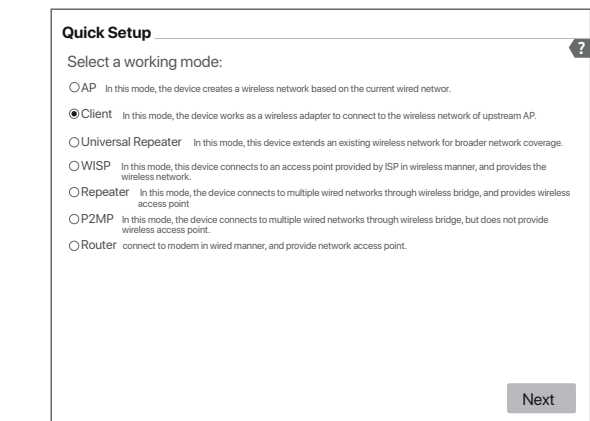

4. Select the **SSID** of Base Station 1, which is **IP-COM_123456** in this example, and click **Next**.

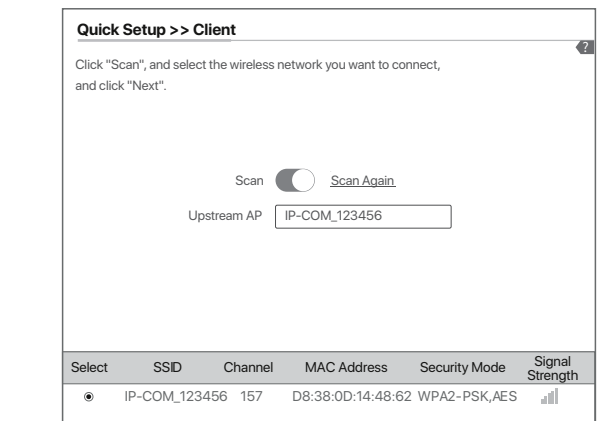

5. Enter the key of Base Station 1, and click **Next**.

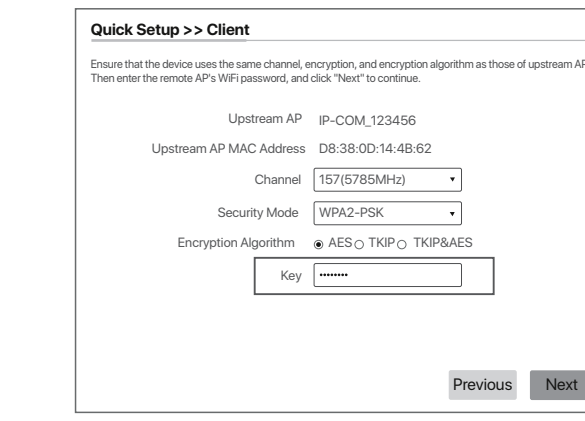

6. Set the IP address to an unused IP address belonging to the same network segment as that of Base Station 1. For example, if the IP address of Base Station 1 is 192.168.2.1, you can set the IP address of this Base Station to 192.168.2.X (X ranges from 2 to 254). Then click **Next**.

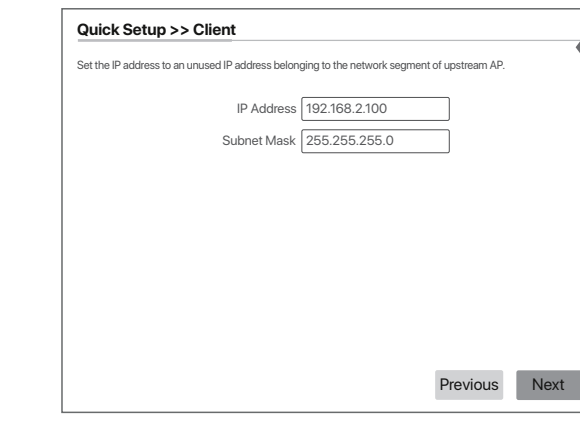

7. Click **Save**, and wait until the Base Station reboots to activate the settings.



When LED1, LED2, and LED3 of the Base Station in **AP** mode are solid on, and LED1, LED2, and LED3 of the Base Station in **Client** mode are blinking, the bridging succeeds. The DHCP servers of the two Base Stations are disabled automatically.

Scenario 2: P2MP connection with sector antenna

The Base Station in **AP** mode can provide WiFi network, allowing home users or small office users to connect to the WiFi network with outdoor long range CPEs. The Base Station can work with some IP-COM CPEs. MS-5AC is used for illustration here.

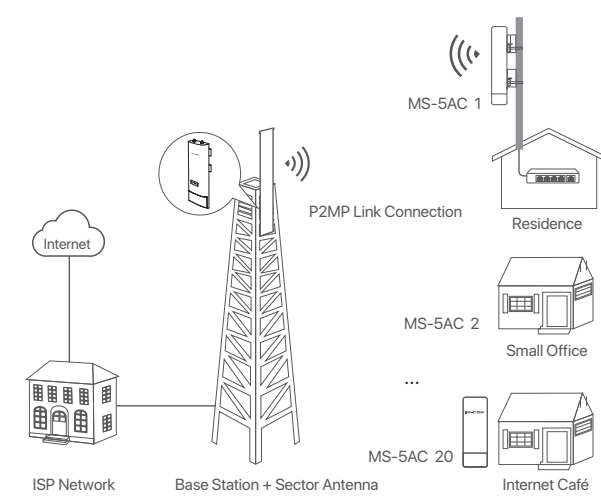

Option 1: Automatic bridging (recommended)

- Tips**
- Automatic bridging is only applicable when the Base Station and CPE are in factory settings.
 - Ensure that only the Base Station and one CPE are powered on when performing peer-to-peer bridging. Otherwise, the peer-to-peer bridging may fail.
 - For peer-to-multiple peers bridging, perform peer-to-peer bridging first, and then power on the rest CPEs within 30 minutes. Otherwise, the bridging may fail.
 - It is recommended to bridge one Base Station to 20 CPEs at most.

- Step 1:** Prepare a Base Station and 20 CPEs (MS-5AC), and put all MS-5AC near the Base Station.
- Step 2:** Choose one MS-5AC to perform peer to peer bridging with the Base Station.
1. Place the Base Station and the MS-5AC next to each other.

2. Remove the covers of the Base Station and MS-5AC, and use Ethernet cables to connect their **PoE/LAN** ports to the **PoE** ports of the PoE injectors.
3. Use the included power cords to connect the PoE injectors to power sources. The **PoE/LAN** LED indicators of the Base Station and MS-5AC light up.

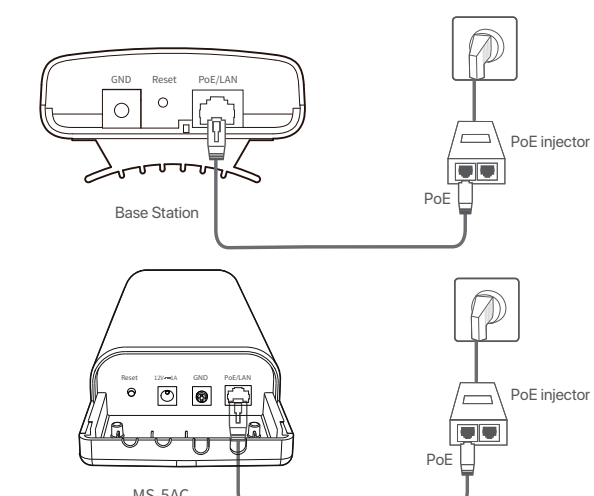

About 1 minute later, when the LED1, LED2 and LED3 indicators of the Base Station light solid on and those of the CPE keep blinking, the automatic bridging succeeds. The DHCP servers of the Base Station and MS-5AC are disabled. MS-5AC works in **Client** mode and its IP address is changed to 192.168.2.2.

- Step 3:** Within 30 minutes after the peer-to-peer bridging succeeds, power other MS-5AC on.
- Step 4:** About 1 minute later, if the LED1, LED2, and LED3 of these CPEs keep blinking, the bridging succeeds.

After the bridging succeeds, the DHCP servers of the CPEs are disabled, and the IP addresses of CPEs working in Client mode are all changed into 192.168.2.2.

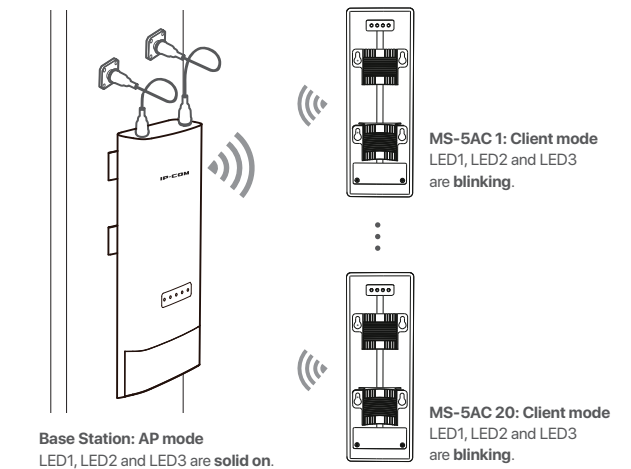

Option 2: Manual bridging

Refer to the configuration procedures in **Scenario 1: PtP backhaul connection with dish antennas** to set the Base Station to the **AP** mode, and set all MS-5AC to **Client** mode.

FAQ

- Q1: I cannot log in to the web UI of the Base Station by entering 192.168.2.1. What should I do?**
- A1:** Try the following methods:
- Ensure that the Base Station has been connected to the power source and the computer properly.
 - Ensure that the IP address of the computer is set to 192.168.2.X (X ranges from 2 to 254 and is unused).
 - Restore the Base Station to factory settings.
- Q2: How to reset the Base Station?**
- A2: Note: Resetting the Base Station clears all settings, and you need to configure it again.**
- Method 1:** When the **Power** LED indicator lights solid on, hold down the **Reset** button for about 8 seconds, then release it when all the LED indicators light up. The Base Station is reset successfully.
- Method 2:** Log in to the web UI of the Base Station, choose **Tools > Maintenance**, and click the **Reset** button.
- Q3: How to check that the Base Station is under the best connection status?**
- A3: Method 1:** Observe the signal strength LED indicators of the Base Station. The connection quality reaches the best when the LED1, LED2 and LED3 indicators of the Base Station light solid on or blink.
- Method 2:** Log in to the web UI of the Base Station (the default IP address is 192.168.2.1), check the bridging status in **Status > Wireless Status**.

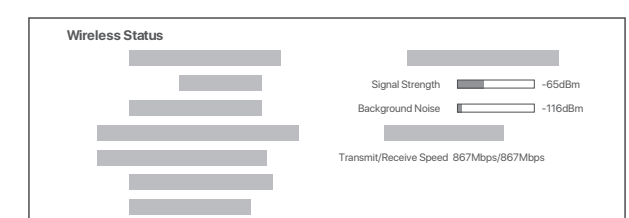

Stronger signal strength (-60 dBm is better than -70 dBm), less background noise (-100 dBm is better than -90 dBm), and fast transmit/receive speed lead to better bridging signal.

- Q4: The automatic bridging fails. What should I do?**
- A4:** Try the following solutions:
- Peer-to-peer bridging: If the peer-to-peer bridging fails, reset the Base Station and CPE to factory settings, and try again.
 - Peer-to-multiple peers bridging: After peer-to-peer bridging succeeds, ensure that the rest CPEs are powered on within 30 minutes. If the problem persists, reset the Base Station and all CPEs, and try again.
- Q5: When the bridging succeeds, the LED1, LED2, and LED3 indicators do not light up or only some of them do. What should I do?**
- A5:** Try the following solutions:
- Place the Base Station and the CPE in an elevated location with few obstacles nearby.
 - Make slight direction adjustment of the Base Station by moving it vertically and horizontally. Change the direction with an interval of 20-30 s each time in order to observe the change of LED1, LED2 and LED3 indicators until the best signal is received.

CE Mark Warning

This is a Class A product. In a domestic environment, this product may cause radio interference, in which case the user may be required to take adequate measures.

This equipment should be installed and operated with a minimum distance 20cm between the device and your body.

The mains plug is used as disconnect device, the disconnect device shall remain readily operable.

NOTE: (1) The manufacturer is not responsible for any radio or TV interference caused by unauthorized modifications to this equipment. (2) To avoid unnecessary radiation interference, it is recommended to use a shielded RJ45 cable.

Declaration of Conformity

Hereby, SHENZHEN IP-COM Networks Co., Ltd. declares that the radio equipment type BSS9 is in compliance with Directive 2014/53/EU. The full text of the EU declaration of conformity is available at the following internet address: <http://ip-com.com.cn/en/cs.html>

Operating Frequency: EU/5150-5250MHz (CH36-CH48)
 EIRP Power (Max.): 22.98dBm
 Operating Frequency: EU/5470-5725MHz (CH100-CH116, CH132-CH140)
 EIRP Power (Max.): 26.98dBm
 Software Version: V1.0.0.10

Caution:
 Adapter Model: BN60E-P12024
 Manufacturer: SHENZHEN HEWEISHUN NETWORK TECHNOLOGY CO., LTD.
 Input: 100 - 240V AC, 50/60Hz 0.3A
 Output: 24V=0.5A
 ---DC Voltage

RECYCLING

This product bears the selective sorting symbol for Waste electrical and electronic equipment (WEEE). This means that this product must be handled pursuant to European directive 2012/19/EU in order to be recycled or dismantled to minimize its impact on the environment.

User has the choice to give his product to a competent recycling organization or to the retailer when he buys a new electrical or electronic equipment.

Operating Temperature: -30°C - 60°C
 Operating Humidity: 10% - 90% RH, non-condensing

For EU/EFTA, this product can be used in the following countries:

FC

FCC Statement

This equipment has been tested and found to comply with the limits for a Class A digital device, pursuant to Part 15 of the FCC Rules. These limits are designed to provide reasonable protection against harmful interference when the equipment is operated in a commercial environment. This equipment generates, uses, and can radiate radio frequency energy and, if not installed and used in accordance with the instruction manual, may cause harmful interference to radio communications. Operation of this equipment in a residential area is likely to cause harmful interference in which case the user will be required to correct the interference at his own expense.

Operation is subject to the following two conditions: (1) this device may not cause harmful interference, and (2) this device must accept any interference received, including interference that may cause undesired operation.

Radiation Exposure Statement

This device complies with FCC radiation exposure limits set forth for an uncontrolled environment and it also complies with Part 15 of the FCC RF Rules. This equipment should be installed and operated with minimum distance 20cm between the device and your body.

Caution!

Any changes or modifications not expressly approved by the party responsible for compliance could void the user's authority to operate the equipment. This transmitter must not be co-located or operating in conjunction with any other antenna or transmitter.

Operating frequency: 5150-5250MHz, 5725-5850MHz

NOTE: (1) The manufacturer is not responsible for any radio or TV interference caused by unauthorized modifications to this equipment. (2) To avoid unnecessary radiation interference, it is recommended to use a shielded RJ45 cable.

Technical Support

Address: Room 101, Unit A, First Floor, Tower E3, NO.1001, Zhongshanyuan Road, Nanshan District, Shenzhen, China. 518052
 Tel: (86755) 2765 3089
 Email: info@ip-com.com.cn
 Website: www.ip-com.com.cn

Copyright

©2021 IP-COM Networks Co., Ltd. All rights reserved.
 This documentation (including pictures, images, and product specifications, etc.) is for reference only. To improve internal design, operational function, and/or reliability, IP-COM reserves the right to make changes to the products described in this document without obligation to notify any person or organization of such revisions or changes.