

# TAKEX

# PASSIVE INFRARED SENSOR

Wide angle protection : PA-450E

Vertical curtain protection : PA-460E

## Instruction Manual

We appreciate your purchase of a TAKEX passive infrared sensor. This sensor will provide long and dependable service when properly installed. Please read this Instruction Manual carefully for correct and effective use.

**Please Note :** This sensor is designed to detect intrusion and to initiate an alarm ; it is not a burglary-preventing device.

TAKEX is not responsible for damage, injury or losses caused by accident, theft, Acts of God ( including inductive surge by lightning ), abuse, misuse, abnormal usage, faulty installation or improper maintenance.

## 1. PARTS DESCRIPTION

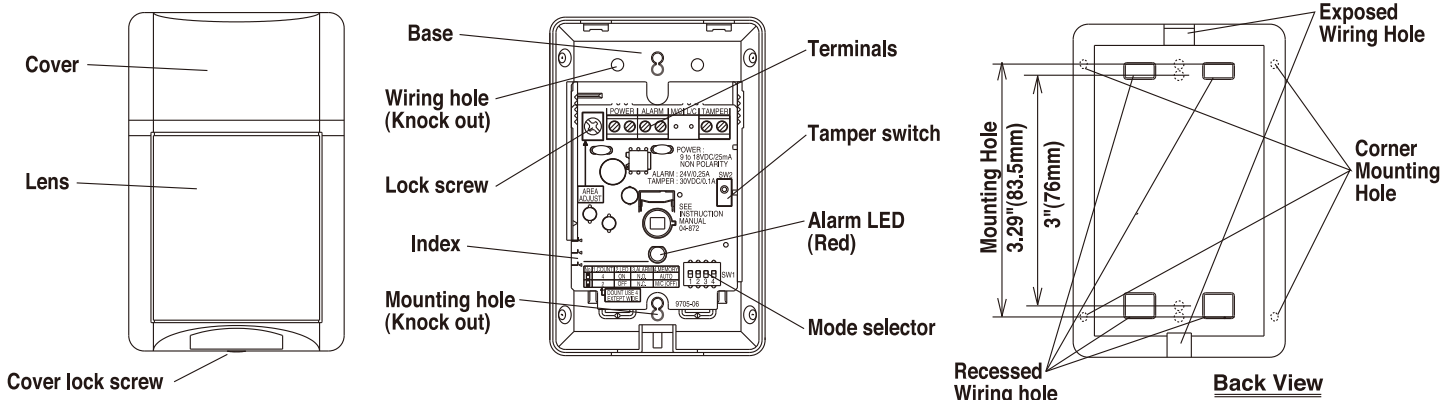

## 2. DO'S AND DON'T'S

- Install the sensor in a location such that intruders are more likely to cross the protection zones, rather than approach head on.
- Do not install in a site which is subject to electrical noise or intense vibration.
- Avoid direct sunlight, spot light or intense reflections on the sensor or the protection zone.
- Do not install the sensor outdoors (indoor use only).
- Do not install the sensor directly on the ceiling. (When installed on ceiling, use optional attachment BCW-401.)

- The passive infrared sensor is designed to detect infrared energy variations caused by the presence of a human body. Therefore, note that similar variations in conditions in protection area, due to other reasons, may cause the sensor to create an alarm as it is unable to distinguish between sources.

### [MAINTENANCE]

- When the unit is soiled, clean the cover with a soft cloth moistened with a small amount of cleansing solution. Do not use chemicals such as thinners or alcohol.
- Check operation once a week. Do not fail to check operation whenever furniture in coverage area is moved.

## 3. COVERAGE AND RANGE

### Wide Angle (PA-450)

unit : ft (m)

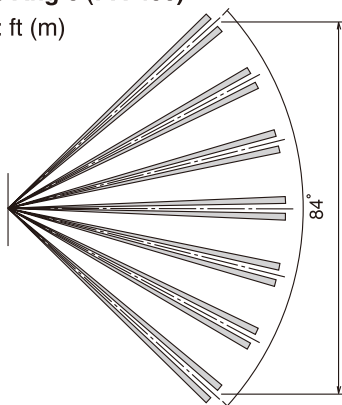

The area of protection can be adjusted to allow for different mounting heights as below side view. Loosen Lock Screw, and by moving the inner PCB upwards, the coverage of the sensor can be shortened. There are three field coverage index marks that are printed onto the PCB located on the left hand side just below the left PCB guide rail. They are to be matched to the bottom of the guide rail. If the PCB is raised past the bottom index the tamper plunger will not activate, leaving the circuit open; in alarm.

### Vertical Curtain (PA-460)

Side view

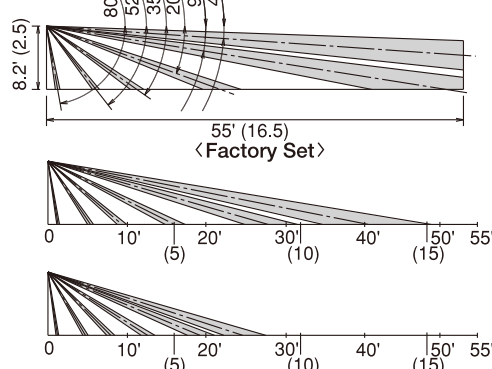
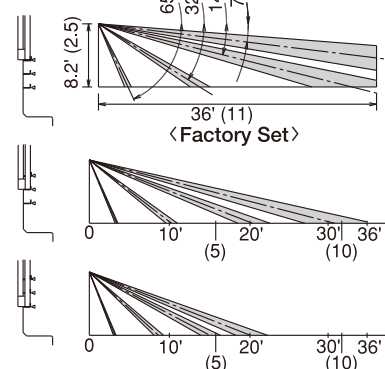

## 4. WIRING

POWER	ALARM	M	L	TAMPER
10~18VDC	24V/0.25A	/	/	30VDC/0.1A
25mA	(AC/DC)	C	C	N.C.
non-polarity	N.C./N.O.			

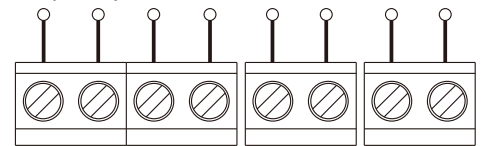

[M/C, L/C optional]

### [ Allowable wiring distance between sensor and power source ]

Size of wire used	Distance at 12VDC
AWG 22 (Dia. 0.65mm)	830 ft. (250m)
AWG 20 (Dia. 0.80mm)	1470 ft. (450m)
AWG 18 (Dia. 1.00mm)	2300 ft. (700m)

- The maximum wire length, when two or more units are connected, is the above distance divided by the number of units.
- The protection circuit can be wired to a distance of 3,280 ft (1,000m) with AWG 22 (0.65mm dia.) wire.
- All wiring should be in accordance with the national electric code NFPA-70.
- The power supply used with this unit must have a minimum 4 hours standby power capability.

## 5. INSTALLATION

1. Loosen cover lock screw and detach the cover.
  2. Open knockout hole.
  3. Install the base on the wall.
- \* Two mounting pitches are available.  
 \* When installed on wall corner, make use of knockouts on sides.  
 4. Connect wires to terminals (Refer to 4. WIRING)  
 \* Plug up an opening of wiring hole .  
 5. Attach the cover, and tighten cover lock screw.

## 7. MODE SETTING

Sensor operation can be changed by mode selector on PWB unit.

### ●Pulse count : 1

- 4 : Least sensitive, prevents false alarms caused by temperature fluctuation.
  - 2 : Normally set to this position.
- \* Do not use 4 pulse count except wide angle.  
 \* Pulse count 4 setting Not for UL installations.

### ●Alarm LED : 2

- ON : Lights at alarm  
 OFF : LED disabled  
 \* Memory function always activate.

### ●Selection of alarm contact : 3

- N.O. : Close at alarm  
 N.C. : Open at alarm

### ●AUTO RESET MEMORY : 4

- Auto : Auto reset operation  
 OFF : No operation

**Operation :** Memory is always stored when sensor is armed.

When an alarm has been activated, the alarm LED blinking for 3 min. and then remains lit for 47 min. It automatically reset and memory is also canceled. In case that the sensor retriggers while its LED is lit, LED lights for further 47 min. after that.

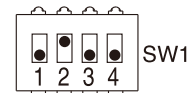

Factory set

## 8. SPECIFICATIONS

Model	PA-450E	PA-460E
Detection system	Passive infrared	
Coverage	Wide Angle 36' (11m) Max.	Vertical curtain 55' (16.5m) Max.
Sensitive zone	18 Pairs	6 Pairs
Supply voltage	10 to 18V DC (non-polarity)	
Current consumption	25mA Max.	
Alarm output	Dry contact (Semi-Conductor) (N.O. / N.C. selectable) Reset : Approx. 2sec., Rating : 24V, 0.25A Max (protective resistance 3.3Ω)	
Tamper output	0.1A 30V N.C.	
Alarm LED (Red)	: Blinking at warming up : Lighting at alarm (LED disabled) : Blinking at memory activated (3 min.) : Lighting at memory indication (47 min.)	
Coverage adjustment	Vertically 3 steps	
Pulse count	2/4 selectable	2
Alarm memory	Autoreset : 3 minutes blinking, 47 minutes lighting and automatically reset	
Low voltage notice	Dry contact alarm	
Ambient temperature range	-15°C to +55°C (+5°F to +131°F) without condensation	
Mounting position	Indoor use only (ceiling mount with optional attachment BCW-401)	
Weight	120g (4.2oz)	
Appearance	Body : ABS resin Lens : PE resin	

The specifications are subject to change without notice.

## 9. EXTERNAL DIMENSIONS

unit : inch(mm)

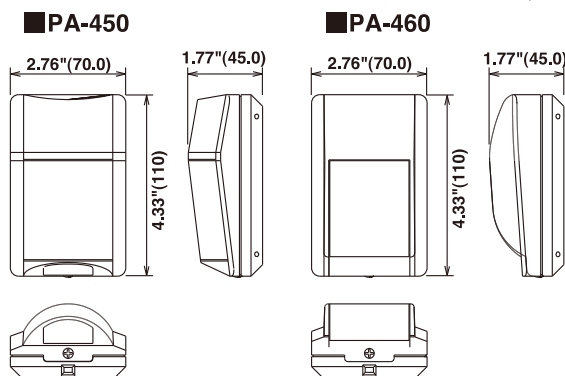

## 10. M/C, L/C (Optional)

The M/C function that can confirm later which sensor triggered an alarm when two or more units are installed on the same alarm signal zone.

### [Manual control memory]

**Set up :** Wire power (+) terminal with M/C terminal through contact switch which is placed nearby controls. Set switch 4 at 'M/C'.

**Operation :** When the sensor is armed, turn the contact switch on to set memory function ON. When an alarm is activated during armed condition, memory is stored. A sensor that has initiated an alarm in protection condition lights its LED continuously when protection is released and contact switch is turned OFF. When again turning the contact switch ON after checking the indication, the indication is over and memory is canceled.

### [Auto-reset memory]

**Set up :** Turning the contact switch ON after. Set switch 4 at 'AUTO'.

**Operation :** Same as AUTO RESET MEMORY  
 (Refer to 7. Mode Setting)

The L/C function allows control of the LED from the control panel.

**Set up :** Wire power - terminal with L/C terminal through contact switch which is placed nearby controls. Set switch 2 at OFF.

**Operation :** When external switch is turned ON, the LED lights at alarm. When external switch is turned OFF, the LED does not light.

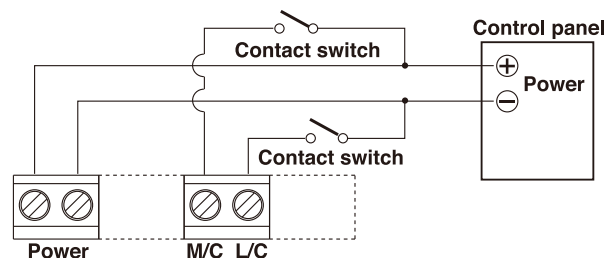

### Limited Warranty :

TAKEX products are warranted to be free from defects in material and workmanship for 12 months from original date of shipment. Our warranty does not cover damage or failure caused by Acts of God, abuse misuse, abnormal usage, faulty installation, improper maintenance or any repairs other than those provided by TAKEX. All implied warranties with respect to TAKEX, including implied warranties for merchantability and implied warranties for fitness, are limited in duration to 12 months from original date of shipment. During the Warranty Period, TAKEX will repair or replace, at its sole option, free of charge, any defective parts returned prepaid. Please provide the model number of the products, original date of shipment and nature of difficulty being experienced. There will be charges rendered for product repairs made after our Warranty Period has expired.



**TAKENAKA ENGINEERING CO., LTD.**

#### In Japan

**Takenaka Engineering Co., Ltd.**  
 83-1, Gojo-sotokan, Higashino,  
 Yamashina-ku, Kyoto 607-8156, Japan  
 Tel : 81-75-501-6651  
 Fax : 81-75-593-3816  
<http://www.takex-eng.co.jp/>

#### In the U.S.

**Takex America Inc.**  
 230E, Caribbean Drive  
 Sunnyvale, CA 94086, U.S.A.  
 Tel : 408-747-0100  
 Fax : 408-734-1100  
<http://www.takex.com>

#### In Australia

**Takex America Inc.**  
 Unit 16/35 Garden Road, Clayton,  
 3168 Victoria, Australia  
 Tel : 03-9546-0533  
 Fax : 03-9547-9450

#### In the U.K.

**Takex Europe Ltd.**  
 Takex House, Aviary Court, Wade Road,  
 Basingstoke, Hampshire. RG24 8PE, U.K.  
 Tel : (+44) 01256-475555  
 Fax : (+44) 01256-466268  
<http://www.takexurope.com>