

9 TROUBLESHOOTING

Solve possible problems according to the following table. If normal operations cannot be restored by this means, contact either the dealer from whom you bought the unit or TAKEX.

Trouble	Check	Corrective Action
Completely inactive	No power supply, broken wire or improper voltage.	Correct power supply or replace broken wire.
	Not yet 1 minute after power turned on (Alarm LED is flickering.)	Allow for warming up time (about 1 min.)
	Cover shielded by substances (including glass).	Remove the substances.
	Improper area adjustment.	Readjust the protection area setting.
Sometimes inactive	Improper area adjustment.	Readjust the protection area setting.
	Cover face is soiled with dust or water drop.	Clean the cover with soft cloth. (Do not use chemicals such as thinners or alcohol.)
	Is the protection range proper ?	Reposition so that the range is proper.
Activated when no person has passed	Unstable power voltage.	Stabilize the power voltage.
	Something moving in protected area or too rapid temperature variations.	Remove the cause.
	Large electrical noise source such as power machine nearby or its wiring close to that of sensor.	Relocate device.
	Intense reflection of sun light or head light shining on the sensor.	Relocate device. Shield with a blind.
	Is the sensor reacting to passersby outside ?	Readjust the protection area.
The alarm LED lights, but connected units are inactive	Poor contact output connection or broken wire or short circuit.	Check the wiring or connection.
	Contact output is not working.	Check the contact output terminal using a tester.
	Is the connected unit operation normal ?	Check the connected unit.

10 SPECIFICATIONS

Model	PA-6812ER
Detection system	Passive infrared
Coverage	Wide angle 40' (12m) Max.
Sensitive zone	17 pairs
Supply voltage	10.5 to 30V DC (non-polarity)
Current consumption	25mA Max.
Alarm output	Dry contact (Semi-conductor) (N.C. / N.O. changeover) Reset : Approx. 2 sec., 24V (AC/DC) 0.25A (ALM : no need) (protective resistor 3.3Ω)
	Selectable resistor system (if in use A1, A2, contact capacity 24V (AC/DC) 5mA)
Tamper output	Dry contact (circuit line) (N.C. only) Reset : Real time, 30V (AC/DC) 0.25A (EOL : 0Ω)
	Selectable resistor system (if in use E1, E2, contact capacity 30V (AC/DC) 5mA)
Alarm LED	Red : Flashing at warming up Lighting at alarm (LED disabled)
Adjustment	Vertically : 30°, Horizontally : 15° (on mounting hole of base)
Count changeover	1 / 2 / 3 / 4 changeover
Ambient temperature range	+5° F to +131° F (-15° C to +55° C) without condensation
Mounting position	Indoor ceiling (wall mount with optional attachment BCW-401)
Wiring connection	Terminals on separate base unit
Weight	4.55 oz (130g)
Appearance	Body : ABS resin Cover : PE resin
Accessory	Tapping screw : 1 pc.

The specifications are subject to change without notice.

Limited Warranty :

TAKEX products are warranted to be free from defects in material and workmanship for 12 months from original date of shipment. Our warranty does not cover damage or failure caused by natural disasters, abuse, misuse, abnormal usage, faulty installation, improper maintenance or any repairs other than those provided by TAKEX. All implied warranties with respect to TAKEX, including implied warranties for merchantability and implied warranties for fitness, are limited in duration to 12 months from original date of shipment. During the Warranty Period, TAKEX will repair or replace, at its sole option, free of charge, any defective parts returned prepaid. Please provide the model number of the products, original date of shipment and nature of difficulty being experienced. There will be charges rendered for product repairs made after our Warranty Period has expired.

11 EXTERNAL DIMENSIONS

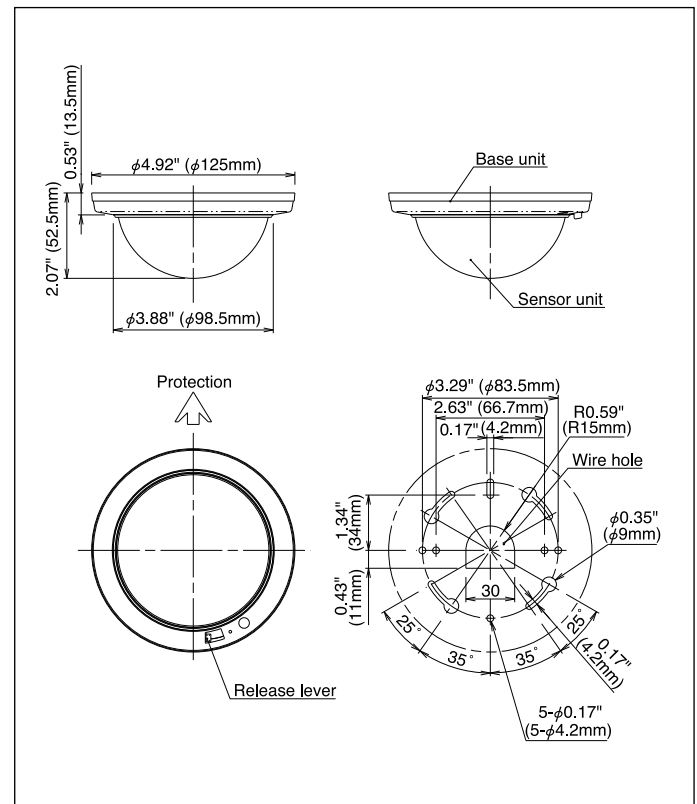

TAKEX PASSIVE INFRARED SENSOR

Wide angle protection : PA-6812ER

Instruction Manual

We appreciate your purchase of a TAKEX passive infrared sensor. This sensor will provide long and dependable service when properly installed. Please read this Instruction Manual carefully for correct and effective use.
Please Note : This sensor is designed to detect intrusion and to initiate an alarm ; it is not a burglary-preventing device. TAKEX is not responsible for damage, injury or losses caused by accident, theft, Acts of God (including inductive surge by lightning), abuse, misuse, abnormal usage, faulty installation or improper maintenance.

1 PARTS DESCRIPTION

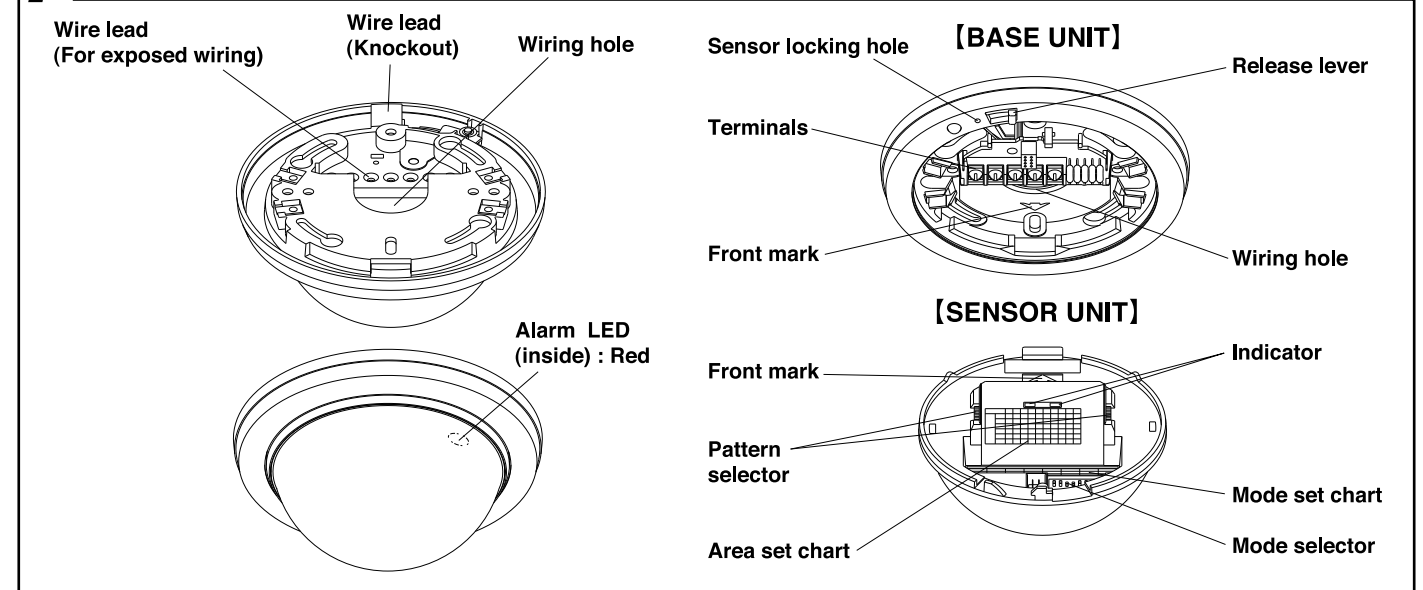

2 COVERAGE AND RANGE

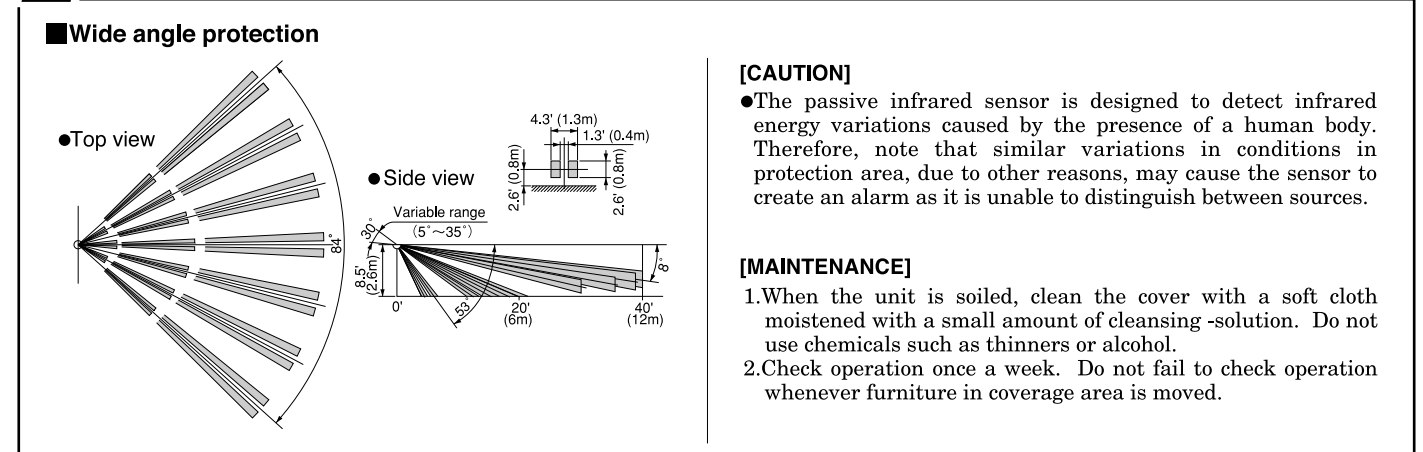

3 DO'S AND DON'T'S

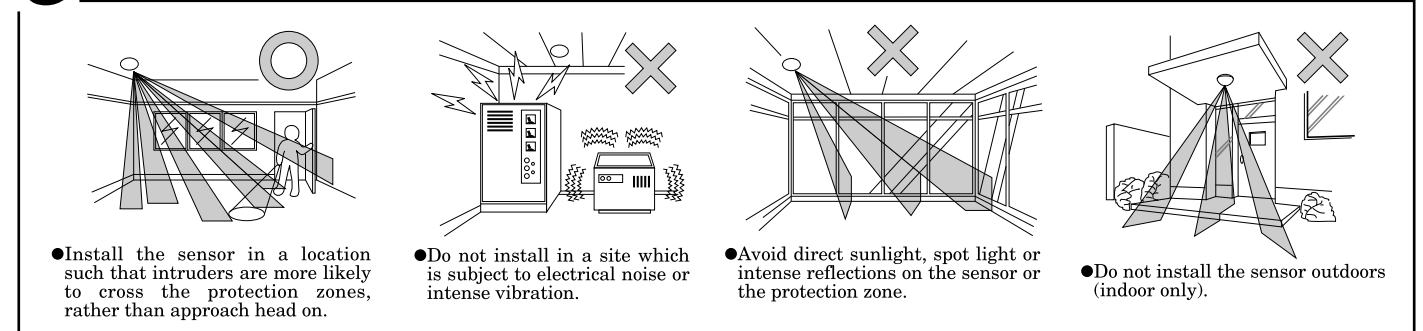

TAKEX TAKENAKA ENGINEERING CO., LTD.

In Japan
 Takenaka Engineering Co., Ltd.
 83-1, Gojo-sotokan, Higashino,
 Yamashina-ku, Kyoto 607-8156, Japan
 Tel : 81-75-501-6651
 Fax : 81-75-593-3816
 http : // www. takex-eng. co. jp /

In the U.S.
 Takex America Inc.
 230E, Caribbean Drive
 Sunnyvale, CA 94086, U.S.A.
 Tel : 408-747-0100
 Fax : 408-734-1100
 http : // www. takex. com

In Australia
 Takex America Inc.
 Unit 16/35 Garden Road, Clayton,
 3168 Victoria, Australia
 Tel : 03-9546-0533
 Fax : 03-9547-9450

In the U.K.
 Takex Europe Ltd.
 Takex House, Aviary Court, Wade Road,
 Basingstoke, Hampshire, RG24 8PE, U.K.
 Tel : (+44) 01256-475555
 Fax : (+44) 01256-466268
 http : // www. takexeurope. com

4 INSTALLATION

(1) Slide release lever to a direction that an arrow points to detach sensor unit from base unit.

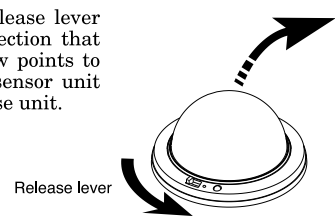

(2) Mount the base on the ceiling with screws. Fix so that the front mark (↑) is pointing to the center of protection area.

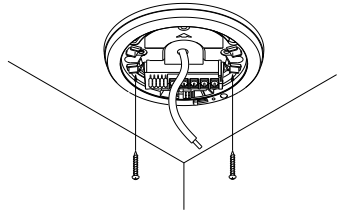

* Break knockout and put the wire through wire lead on base unit, when exposed wiring.

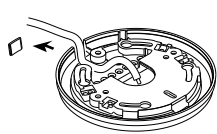

(3) Connect the wires to the terminals referring to the paragraph on WIRING.

(4) Set the protection area referring to the paragraph on PATTERN SETTING.

(5) Match up a front mark on base unit with that on sensor unit.

① Put a sensor unit into a base unit from front mark side.

② Push sensor unit until release lever will click.

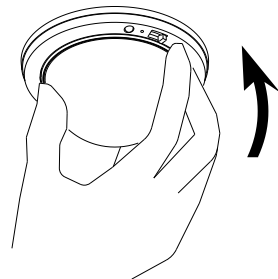
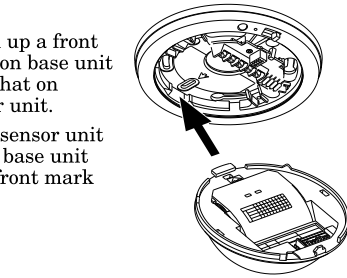

(6) When sensor unit is detached, hold it and slide release lever as illustrated.

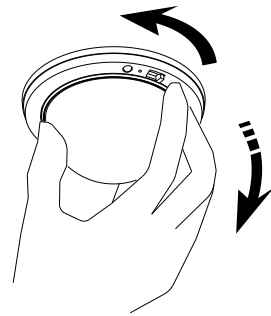

(7) When sensor unit is locked, tighten the tapping screw.

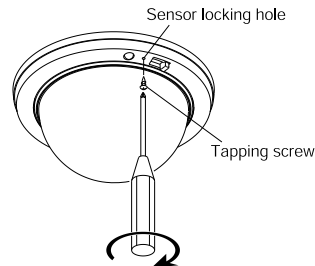

5 WIRING

Cut unnecessary resistor according to the following instructions, otherwise this sensor will not operate properly.

[End of line resistor (EOL)]

3 Tables, E1 (10kΩ), E2 (2.2kΩ), & E3 (0Ω) are located on the base unit. Cut resistor as shown in the following Table 1 according to EOL resistor load required.

(Table 1)

Required	E 1	E 2	E 3
10kΩ	—	Cut	Cut
2.2kΩ	Cut	—	Cut
No need	Cut	Cut	—

[Alarm resistor (ALM)]

2 Tables, A1 (10kΩ), & A2 (6.8kΩ) are located on the base unit. Cut resistor as shown in the following Table 2 according to ALM resistor load required.

(Table 2)

Required	A 1	A 2
10kΩ	—	Cut
6.8kΩ	Cut	—
No need	Cut	Cut

CUT HERE !

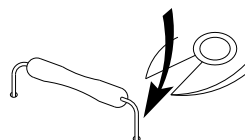

[Terminal]

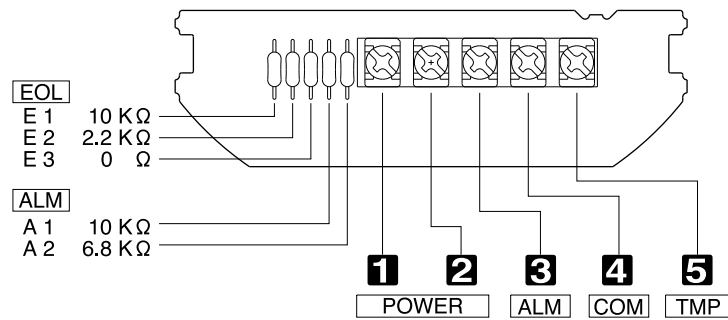

[Sensor Unit]

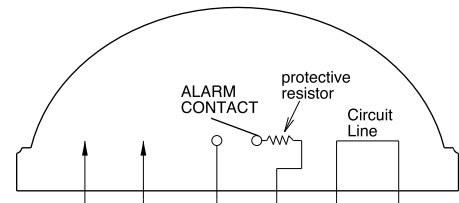

[Base Unit]

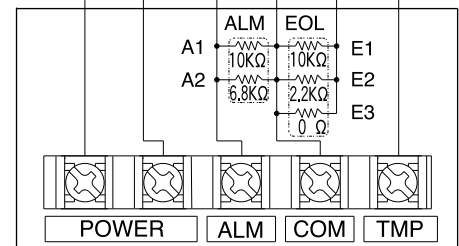

6 PATTERN SETTING

[Vertically] The protection area can be set depending on installation height and max. protection distance by the pattern selector on the rear of sensor, referring to the area set chart.
Note : Alphabet letters appear alternately on the indicator.

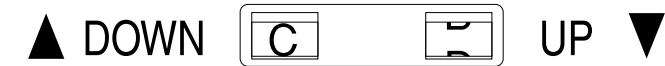

DISTANCE		10	13	16	20	23	26	30	33	36	40	AREA SET CHART	
ft	m	3.0	4.0	4.9	6.0	7.0	8.0	9.1	10.0	11.0	12.0		
HEIGHT	ft	6.5	2.0	G	E	D	C	B	B	A	A	A	UNIT : ft / m
		8.5	2.6	I	G	F	E	D	C	C	B	B	
		10	3.0	K	I	G	F	E	D	D	C	C	
		13	4.0	—	—	J	H	G	F	E	E	D	
	16	4.9	—	—	—	J	I	H	G	F	E	E	

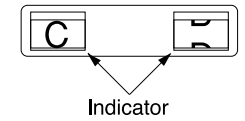

[i.e.]
When the sensor is to protect an area 40' (12m) at 10' (3m) height, turn the pattern selector such that the indicator shows "C".

[Horizontally] Make use of mounting hole for horizontal adjustment. (15° adjustable)

7 OPERATION

- Turn the power ON, and wait for 1 minute until the alarm LED stops flashing.
- Walk test in the protection area to check if an alarm is activated. Check on both of the alarm LED and control panel.
- After correct operation has been confirmed, turn the alarm LED OFF with mode selector on the rear of sensor unit. (When set at OFF, the alarm LED does not light even if an alarm is activated.)

8 MODE SETTING

Sensor operation can be adjusted by mode selectors on the rear of unit to suit its application / environment.

ON	N.O.	120	80	1	3
OFF	N.C.	100	60	2	4
1 LED	2	3ALARM	4,5 SENS. (%)	6,7 COUNT	8

(1) Alarm LED ON/OFF

ON : Lights at alarm
OFF : LED disabled

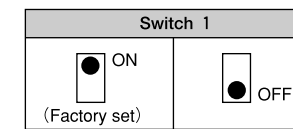

(2) Changeover of alarm contact

ON : N.O.
OFF : N.C.

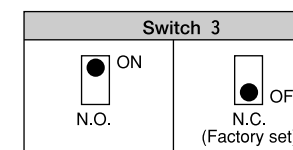

(3) Sensitivity

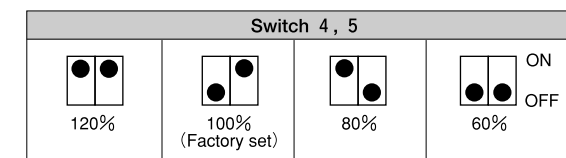

(4) Pulse count

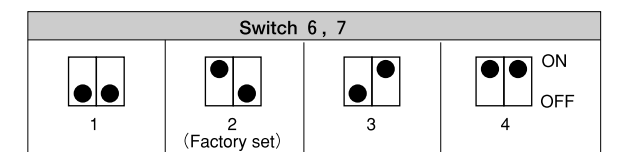

- 1 : Most sensitive.
- 2 : Normally set to this position.
- 3 / 4 : Least sensitive, prevents false alarms caused by temperature fluctuation.

FACTORY SET AT

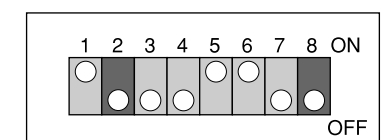

(Set switch 2, 8 at OFF)