

Black 8MP HD Intelligent Light and Audible Warning Fixed Eyeball Network Camera

IPC3618SB-ADF28(40)KMC-IO-BK



Key Features



- High quality image with 8MP, 1/2.8"CMOS sensor
- 8MP (3840*2160)@20fps; 5MP (3072*1728)@30/25fps; 4MP (2560*1440)@30/25fps; 2MP (1920*1080) @30/25fps
- Ultra 265, H.265, H.264, MJPEG
- Smart intrusion prevention, support false alarm filtering, include Cross Line, Intrusion, Enter Area, Leave Area detection
- Supports sound and light alarm linkage. When Smart intrusion prevention is triggered, the camera links sound alarm and light linkage.
- Face capture, automatic selection of best snapshots, support face detection masked area
- People Counting, support people flow counting and crowd density monitoring, suitable for different statistical scenarios
- 120dB true WDR technology enables clear image in strong light scene
- Support 9:16 Corridor Mode
- Built-in Mic and Speaker
- Smart IR, up to 30m (98ft) IR distance
- Supports 256 G Micro SD card
- IP67 protection

Specifications

	IPC3618SB-ADF28KMC-I0-BK	IPC3618SB-ADF40KMC-I0-BK			
Camera					
Sensor	1/2.8", 8.0 megapixel, progressive scan, CMOS				
Minimum Illumination	Color: 0.003Lux (F1.6, AGC ON) 0Lux with IR on				
Day/Night	IR-cut filter with auto switch (ICR)				
Shutter	Auto/Manual, 1 ~ 1/100000s				
Adjustment angle	Pan: 0° ~ 360°	Tilt: 0° ~ 80°		Rotate: 0° ~ 360°	
WDR	120dB				
S/N	>56dB				
Lens					
Lens	2.8mm@F1.6		4.0mm@F1.6		
Angle of View (H)	106.7°		87.5°		
Angle of View (V)	57.1°		46.3°		
Angle of View (O)	115.7°		92.4°		
DORI					
DORI Distance	Lens (mm)	Detect (m)	Observe (m)	Recognize (m)	Identify (m)
	2.8	86.9	34.8	17.4	8.7
	4.0	124.1	49.7	24.8	12.4
Illuminator					
IR Range	Up to 30m (98 ft.) IR range				
Wavelength	850nm				
IR On/Off Control	Auto/Manual				
Video					
Video Compression	Ultra 265, H.265, H.264, MJPEG				
H.264 code profile	Baseline profile, Main profile, High profile				
Frame Rate	Main Stream: 8MP (3840*2160), Max 20fps; 5MP (3072*1728), Max 30fps; 4MP (2560*1440), Max 30fps; 1080P (1920*1080), Max 30fps; Sub Stream: 1080P (1920*1080), Max 30fps; 720P (1280*720), Max 30fps; 640*360, Max 30fps; D1 (720*576), Max 30fps; 2CIF(704*288), Max 30fps; CIF(352*288), Max 30fps; Third Stream: D1 (720*576), Max 30fps; 640*360, Max 30fps; 2CIF(704*288), Max 30fps; CIF(352*288), Max 30fps;				
Video Bit Rate	128 Kbps~16 Mbps				
U-code	Support				
ROI	Up to 8 areas				
Video Stream	Triple streams				
OSD	Up to 8 OSDs				
Privacy Mask	Up to 4 areas				
Image					
White Balance	Auto/Outdoor/Fine Tune/Sodium Lamp/Locked/Auto2				
Image Setting	Image rotation, brightness, saturation, contrast, sharpness, gain adjustable by web browser				
Digital Noise Reduction	2D/3D DNR				
Smart IR	Support				
Flip	Normal/Vertical/Horizontal/180°/90°Clockwise/90°Anti-clockwise				

Dewarping	Supported
HLC	Supported
BLC	Supported
Defog	Digital Defog
Intelligent	
Smart intrusion prevention	Support false alarm filtering: Line crossing detection, Intrusion detection, Region entrance detection, Region exit detection
Face capture	Support
Statistical Analysis	People counting, support tripwire people counting and area people counting
Events	
Basic Detection	Motion detection, tampering alarm, audio detection
General Function	Watermark, IP address filtering, tampering alarm, access policy, ARP protection, RTSP authentication, user authentication
Audio	
Audio Compression	G.711
Audio Bitrate	64 Kbps
Two-way audio	Supported
Suppression	Supported
Sampling Rate	8KHZ
Storage	
Edge Storage	Micro SD, up to 256GB
Network Storage	ANR, NAS(NFS)
Network	
Protocols	IPv4, IGMP, ICMP, ARP, TCP, UDP, DHCP, PPPoE, RTP, RTSP, RTCP, DNS, DDNS, NTP, FTP, UPnP, HTTP, HTTPS, SMTP, 802.1x, SNMP, QoS, RTMP,SSL/TLS, SSH
Compatible Integration	ONVIF (Profile S, Profile G, Profile T), API,SDK
User/Host	Up to 32 users. 2 user levels: administrator and common user
Security	Password protection, Strong password, HTTPS encryption, Export operation logs, Basic and digest authentication for RTSP, Digest authentication for HTTP, TLS 1.2, WSSE and digest authentication for ONVIF
Client	EZStation EZView EZLive
Web Browser	Plug-in required live view: IE9+, Chrome 41 and below, Firefox 52 and below
	Plug-in free live view: Chrome 57.0+, Firefox 58.0+, Edge 16+
Interface	
Audio I/O	N/A
Alarm I/O	N/A
RS485	N/A
Built-in Mic	Support
Built-in Speaker	Support
WIFI	N/A
Network	1 RJ45 10M/100M Base-TX Ethernet
Video Output	N/A
Certifications	
EMC	FCC CFR 47 Part 15 EN 55032:2015 EN 55024:2010 EN 61000-3-2:2014

	EN 61000-3-3-2013
Safety	IEC 62368-1 EN 62368-1 UL 62368-1
Environment	CE-ROHS (2011/65/EU;(EU)2015/863); WEEE (2012/19/EU); REACH (Regulation (EC) No 1907/2006)
General	
Power	DC 12V±25%, PoE (IEEE 802.3af)
	Power consumption: Max 10.5W
Power Interface	Ø 5.5mm coaxial power plug
Dimensions (L x W x H)	Φ111 x 95mm (Φ4.4" x 3.7")
Weight	0.48kg (1.058lb)
Material	Metal + Plastic
Working Environment	-30°C ~ 60°C (-22°F ~ 140°F), Humidity: ≤95% RH (non-condensing)
Storage Environment	-30°C ~ 60°C (-22°F ~ 140°F), Humidity: ≤95% RH (non-condensing)
Surge Protection	4KV
Reset Button	N/A
Protection	Ingression protection: IP67

Dimensions

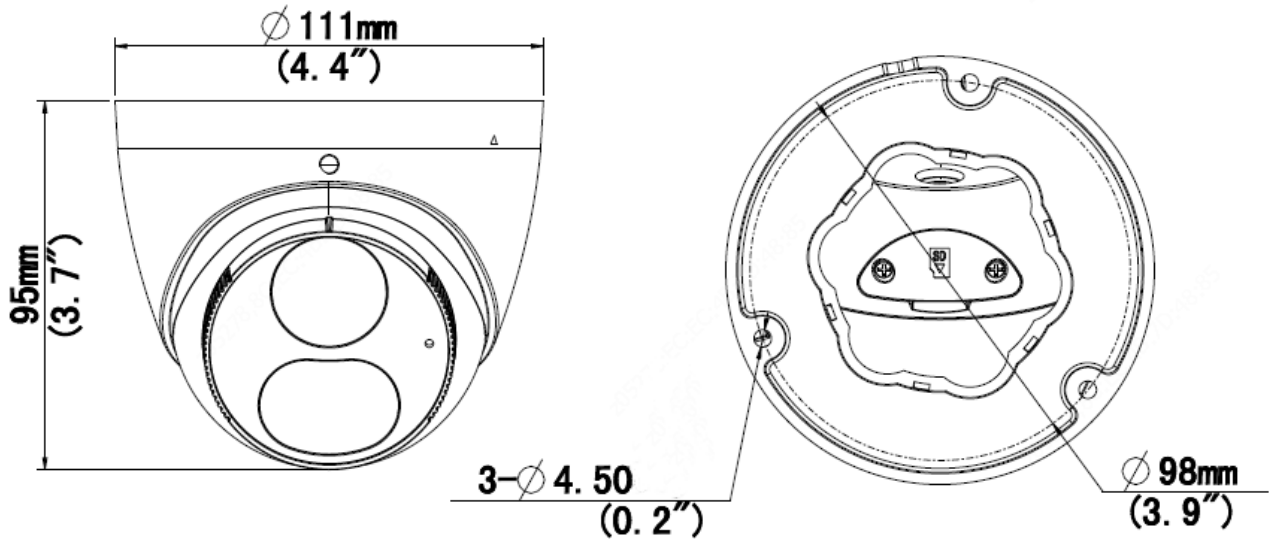

Accessories

TR-JB03-G-IN



TR-JB07/WM03-G-IN

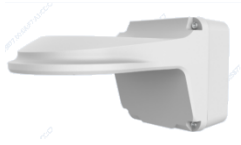

TR-WM03-D-IN

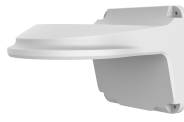

TR-UM06-E-IN



TR-UP06-IN



TR-A01-IN



TR-SE24-IN



TR-SE24-A-IN



TR-CM24-IN

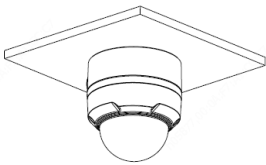
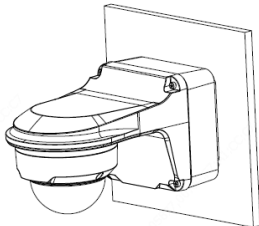

Junction Mount	Pole Mount
TR-JB03-G-IN	TR-JB07/WM03-G-IN
	
TR-UM06-E-IN	TR-JB07/WM03-G-IN+TR-UP06-IN

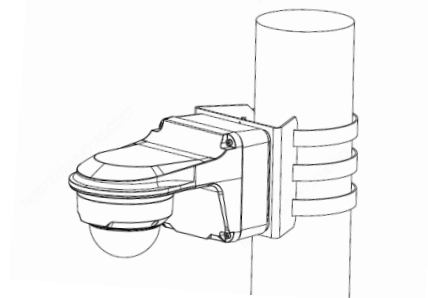
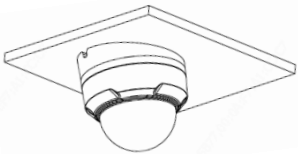

TR-CM24-IN+TR-JB03-G-IN

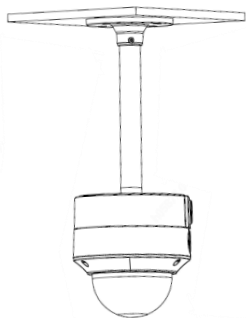

Zhejiang Uniview Technologies Co., Ltd.

Building No.10, Wanlun Science Park, Jiangling Road 88, Binjiang District, Hangzhou, Zhejiang, China (310051)

Email: overseasbusiness@uniview.com; globalsupport@uniview.com

<http://www.uniview.com>

©2020 Zhejiang Uniview Technologies Co., Ltd. All rights reserved.

*Product specifications and availability are subject to change without notice.